

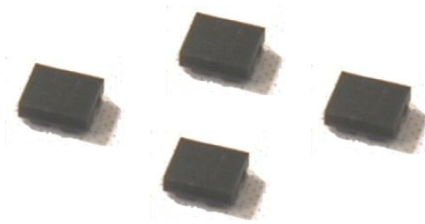

Data Sheet of SAW Components



Note : Murata SAW Component is applicable for Cellular /Cordless phone (Terminal) relevant market only.

Please also read caution at the end of this document.

SAW REJECTION FILTER FOR ISDB-T (1seg)

Murata part number : SAEEN832MWA0B00

Package Dimensions

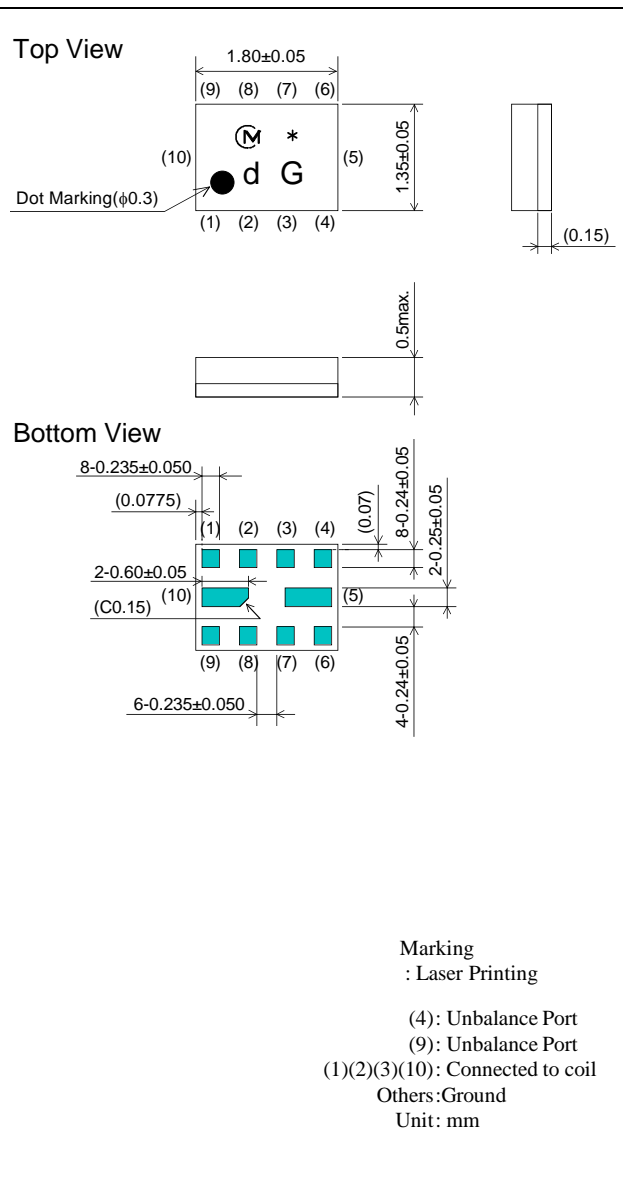

Specification

Item	Specification		
	-30 to 85°C	25±2°C	typ.
Nominal Center Frequency(fc)	832MHz 911.5 MHz		
Insertion Loss			
1) 90 to 222 MHz	10 dB min.	11 dB min.	12.9 dB
2) 470 to 710 MHz	2.1 dB max.	1.8 dB max.	1.55 dB
3) 710 to 770 MHz	3.3 dB max.	2.8 dB max.	2.52 dB
4) 824 to 840 MHz	37 dB min.	39 dB min.	40.5 dB
5) 898 to 925 MHz	37 dB min.	38 dB min.	40.8 dB
6) 1427.9 to 1447.9 MHz	42 dB min.	43 dB min.	48.5 dB
7) 1749.9 to 1784.9 MHz	49 dB min.	50 dB min.	55.5 dB
8) 1920 to 1980 MHz	46 dB min.	47 dB min.	50.7 dB
Unbalance Port Impedance (nominal)	50Ω		
Input Signal Level	251mW(+24dBm), 50000hours		

SAW REJECTION FILTER FOR ISDB-T (1seg)

Murata part number : SAEEN832MWA0B00

Frequency Performance

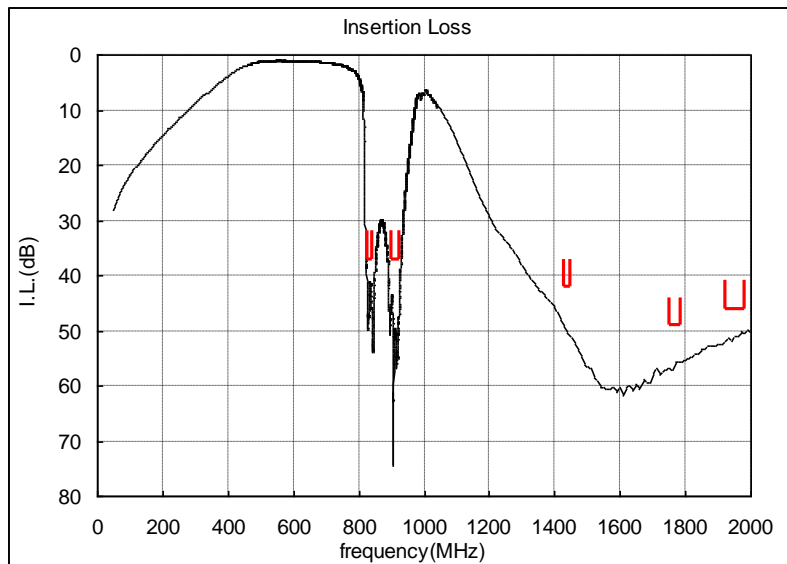
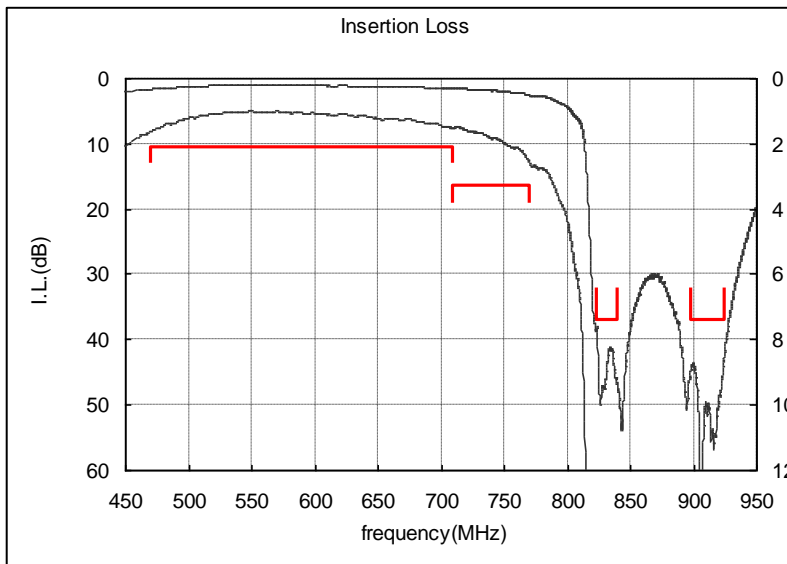

SAW REJECTION FILTER FOR ISDB-T (1seg)

Murata part number : SAEEN832MWA0B00

Dimensions of Carrier Tape

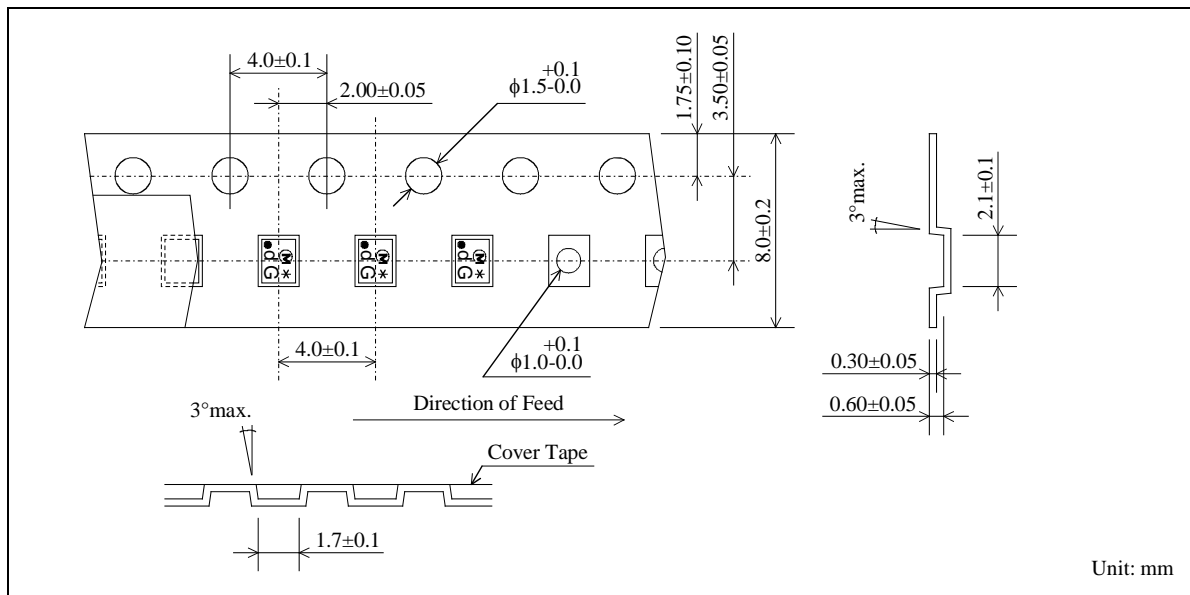

Dimensions of Tape

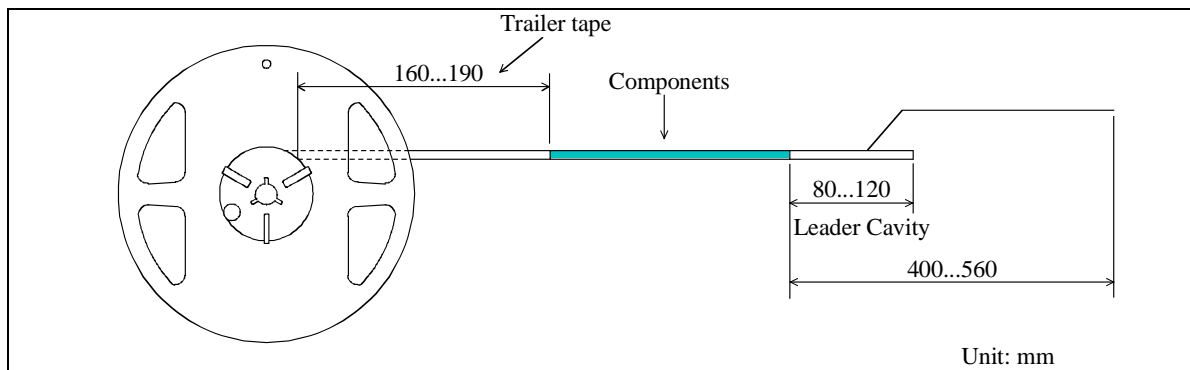

Dimensions of Reel

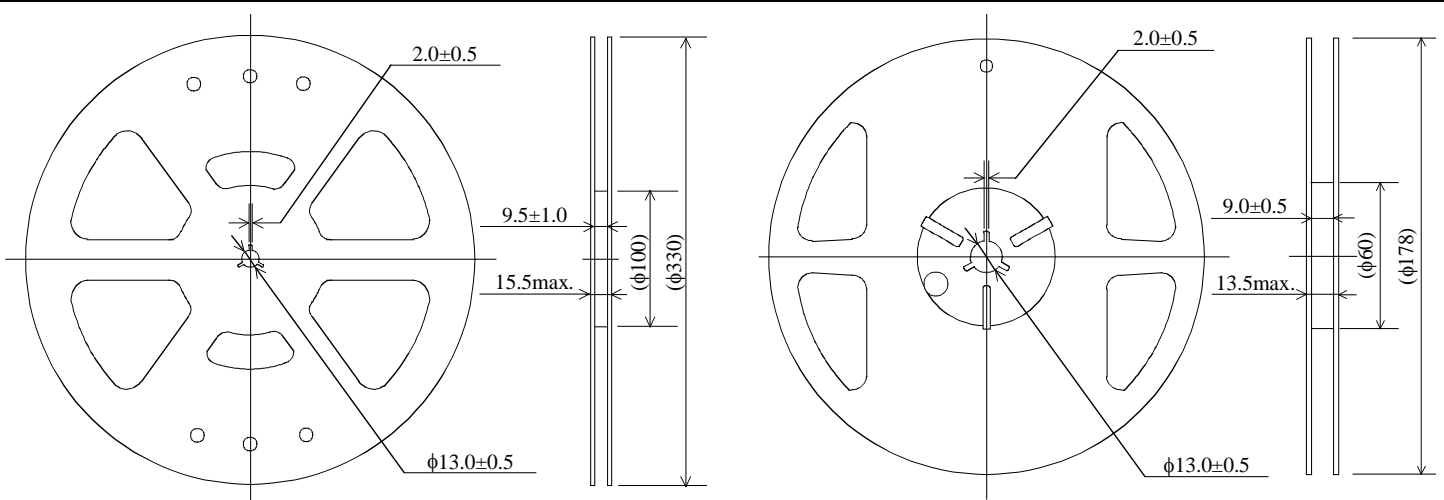

SAEEN832MWA0B00R00 ... 10000pcs/reel

SAEEN832MWA0B00R15 ... 5000pcs/reel

SAW REJECTION FILTER FOR ISDB-T (1seg)

Murata part number : SAEEN832MWA0B00

Recommended Land Pattern

Top View

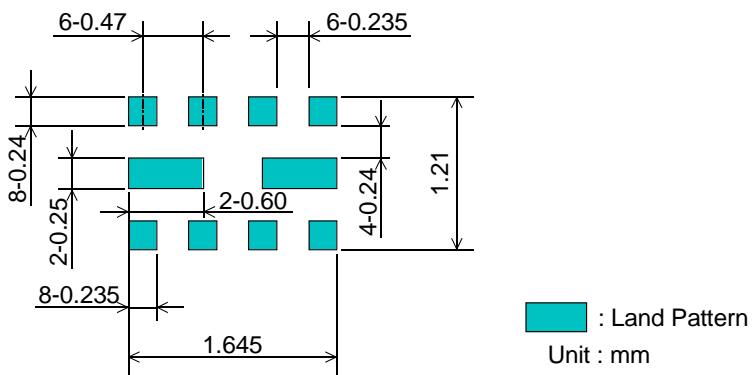

Test Circuit

Bottom View

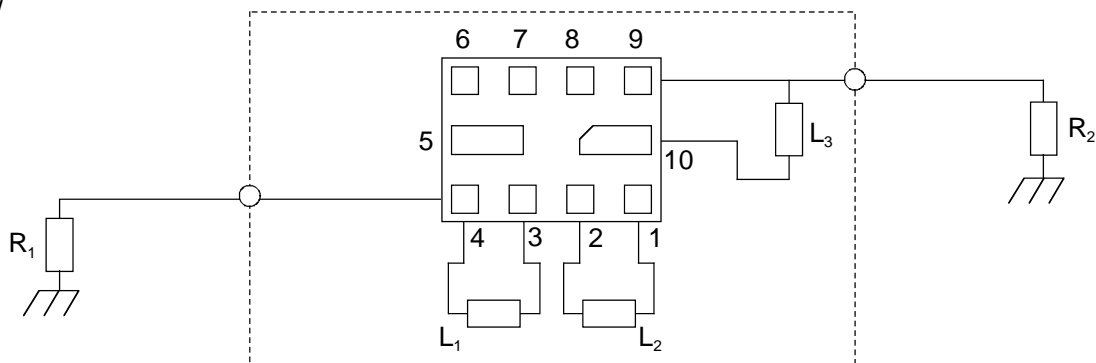

- R1: 50Ω
- R2: 50Ω
- L1: 19nH(LQW15AN19NG00, muRata)
- L2: 27nH(LQW15AN27NG00, muRata)
- L3: 19nH(LQW15AN19NG00, muRata)

SAW REJECTION FILTER FOR ISDB-T (1seg)

Murata part number : SAEEN832MWA0B00

■ RoHS Compliance

This component is compliant with RoHS directive.

This component was always RoHS compliant from the first date of manufacture.

• Caution - Limitation of Applications

This product is intended for the following applications only; however, please do not use this product in these applications where defects might directly cause damage to a third party's life, body or property.

- a. Mobile Telephone
- b. Cordless phone (except for Automotive use)
- c. PC (Including Notebook PC, Netbook PC, Tablet)
- d. Game
- e. Camera (except for Business/security use)
- f. Set Top Box
- g. Electronic dictionary
- h. Digital audio equipment

• This catalog is for reference only and not an official product specification document, therefore, please review and approve our official product specification before ordering this product.