



Data Sheet of SAW Components



Note : Murata SAW Component is applicable for Cellular /Cordless phone (Terminal) relevant market only.

Please also read caution at the end of this document.

SAW FILTER FOR GSM850/GSM900 (Rx)

Murata part number : SAWEP881MCQ0F0Q (fc=881.5MHz)

Package Dimensions

Specification

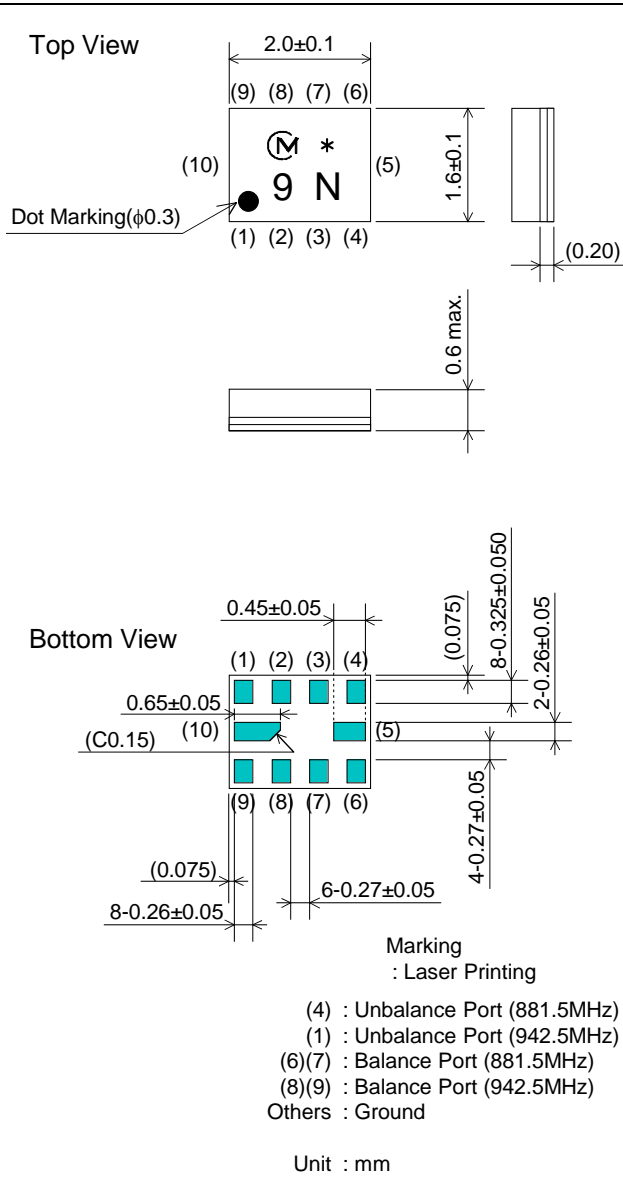

Item	Specification		
	-30 to 85°C	25±2°C	typ.
Nominal Center Frequency(fc)	881.5MHz		
Insertion Loss (869 to 894MHz)	2.0 dB max.	1.9 dB max.	1.6 dB
Absolute Attenuation			
1) 0.1 to 800 MHz	50 dB min.	50 dB min.	62 dB
2) 800 to 824 MHz	50 dB min.	50 dB min.	65 dB
3) 824 to 849 MHz	35 dB min.	38 dB min.	50 dB
4) 914 to 970 MHz	23 dB min.	23 dB min.	27 dB
5) 970 to 2400 MHz	35 dB min.	35 dB min.	54 dB
6) 2400 to 6000 MHz	30 dB min.	30 dB min.	42 dB
Ripple Deviation (869 to 894MHz)	1.1dB max.	0.9dB max.	0.4 dB
VSWR (869 to 894MHz)	2.0 max.	1.9 max.	1.6
Amplitude Balance (869 to 894MHz)	±0.8dB max.	±0.5dB max.	±0.2dB
Phase Balance (869 to 894MHz)	180±5deg. max.	180±5deg. max.	180±2deg.
Unbalance Port Matching Impedance (nominal)	50Ω		
Balance Port Matching Impedance (nominal)	150Ω//82nH		
Input Signal Level	31.6mW (+15dBm), 2000 hours		

SAW FILTER FOR GSM850/GSM900 (Rx)

Murata part number : SAWEP881MCQ0F0Q (fc=881.5MHz)

Frequency Performance

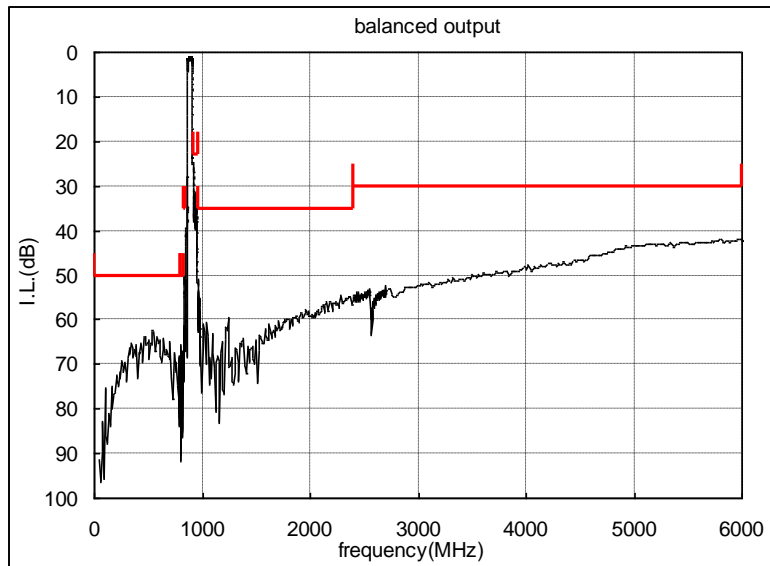
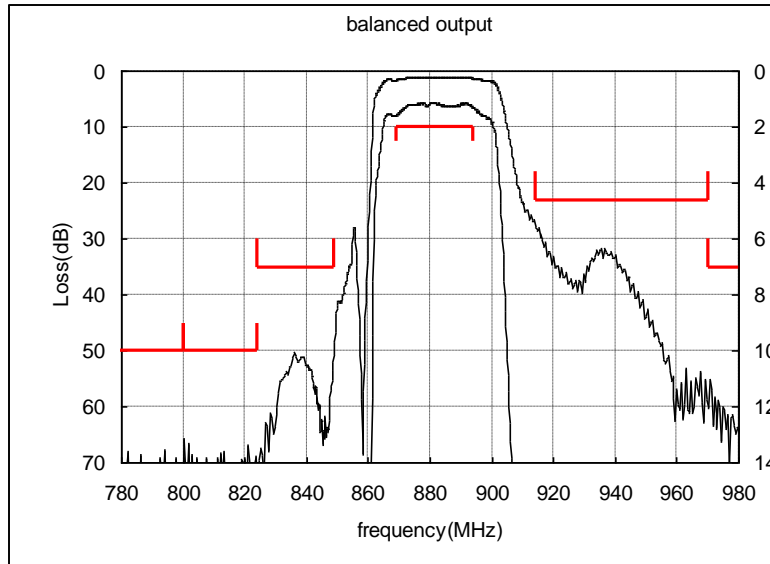

Amplitude balance

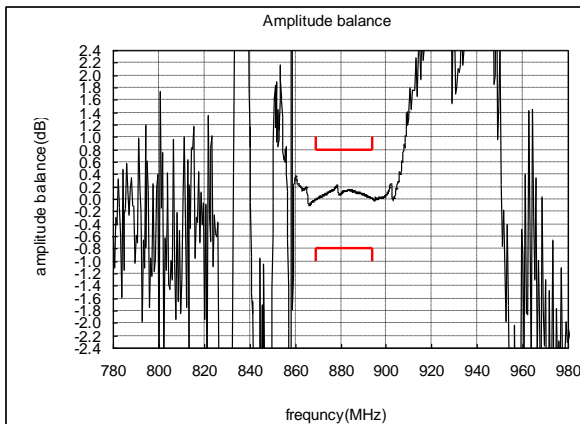

Phase balance

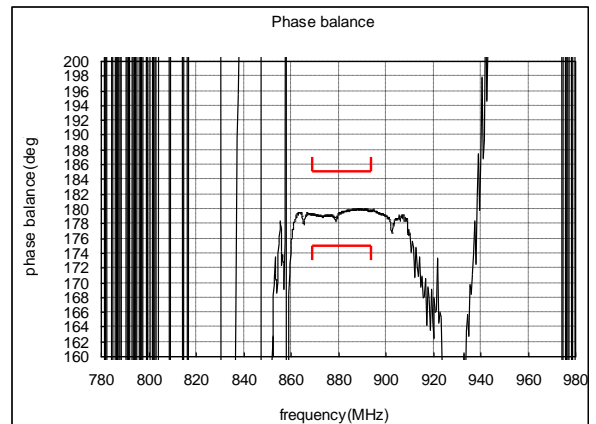

SAW FILTER FOR GSM850/GSM900 (Rx)

Murata part number : SAWEP881MCQ0F0Q (fc=942.5MHz)

Package Dimensions

Specification

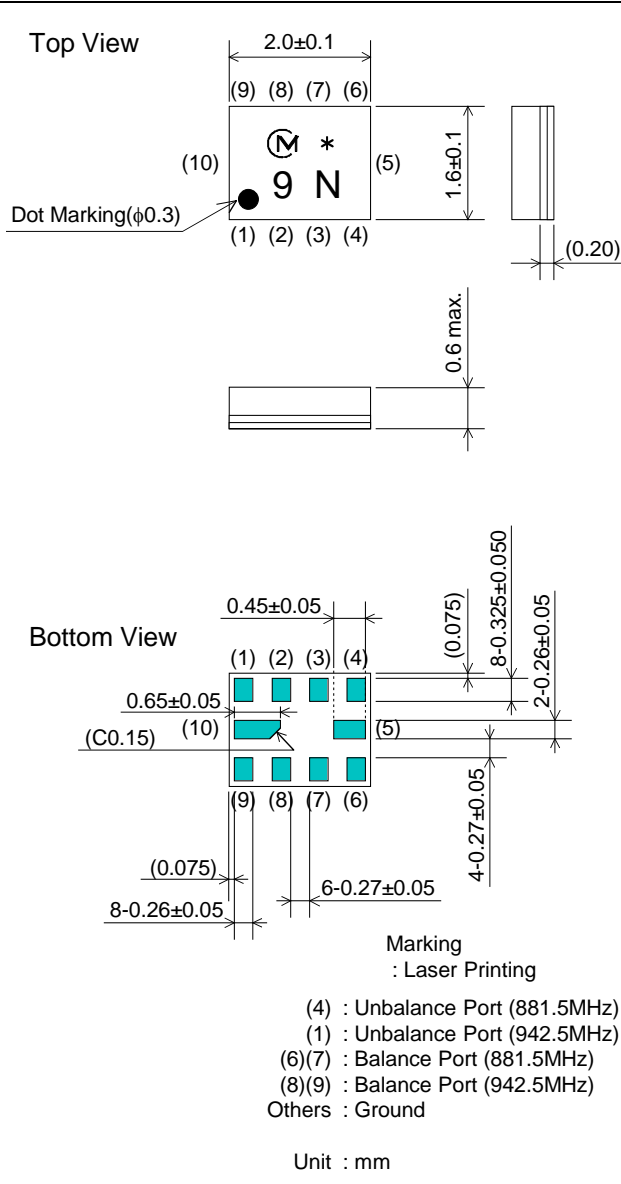

Item	Specification		
	-30 to 85°C	25±2°C	typ.
Nominal Center Frequency(fc)	942.5MHz		
Insertion Loss (925 to 960MHz)	2.4 dB max.	2.1 dB max.	1.7 dB
Absolute Attenuation			
1) 0.1 to 860 MHz	50 dB min.	50 dB min.	64 dB
2) 860 to 880 MHz	50 dB min.	50 dB min.	65 dB
3) 880 to 905 MHz	30 dB min.	32 dB min.	41 dB
4) 905 to 915 MHz	20 dB min.	22 dB min.	29 dB
5) 980 to 1050 MHz	23 dB min.	23 dB min.	28 dB
6) 1050 to 3000 MHz	35 dB min.	35 dB min.	51 dB
7) 3000 to 6000 MHz	30 dB min.	30 dB min.	41 dB
Ripple Deviation (925 to 960MHz)	1.5dB max.	1.3dB max.	0.6 dB
VSWR (925 to 960MHz)	2.1 max.	2.0 max.	1.8
Amplitude Balance (925 to 960MHz)	±0.8dB max.	±0.5dB max.	±0.2dB
Phase Balance (925 to 960MHz)	180±5deg. max.	180±5deg. max.	180±1.2deg.
Unbalance Port Matching Impedance (nominal)	50Ω		
Balance Port Matching Impedance (nominal)	150Ω//82nH		
Input Signal Level	31.6mW (+15dBm), 2000 hours		

SAW FILTER FOR GSM850/GSM900 (Rx)

Murata part number : SAWEP881MCQ0F0Q (fc=942.5MHz)

Frequency Performance

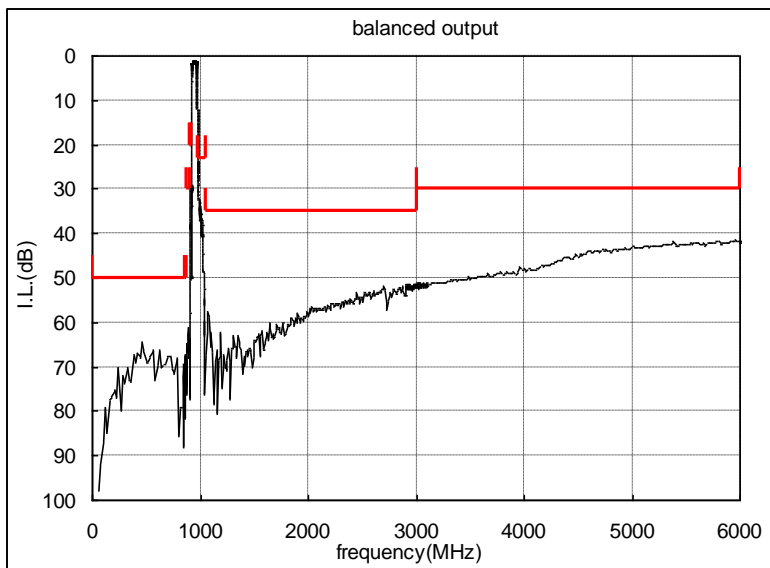
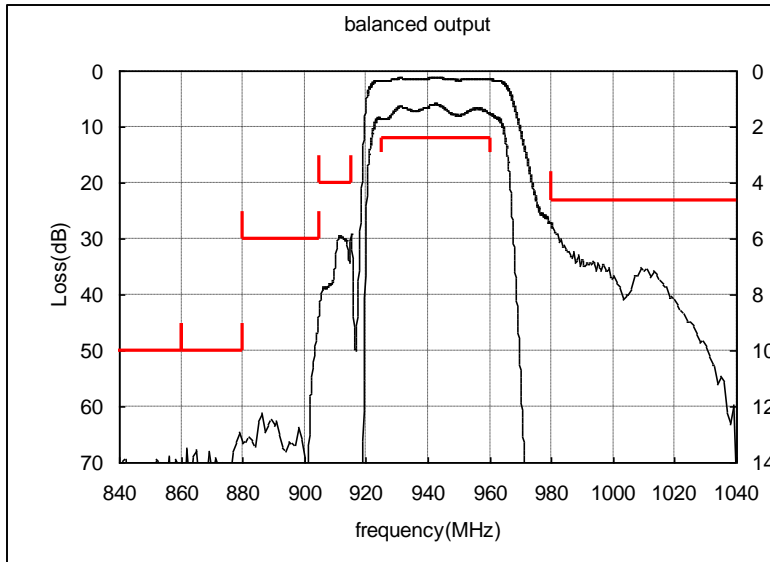

Amplitude balance

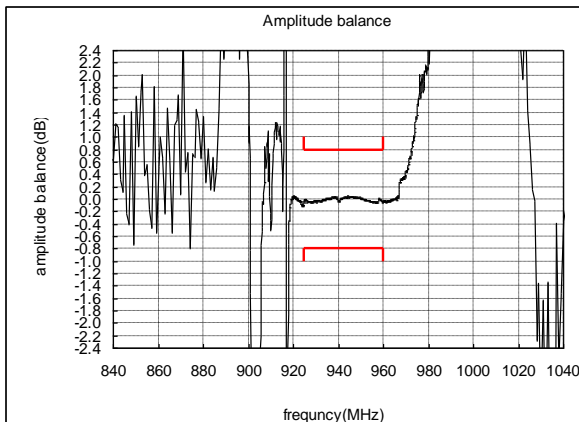

Phase balance

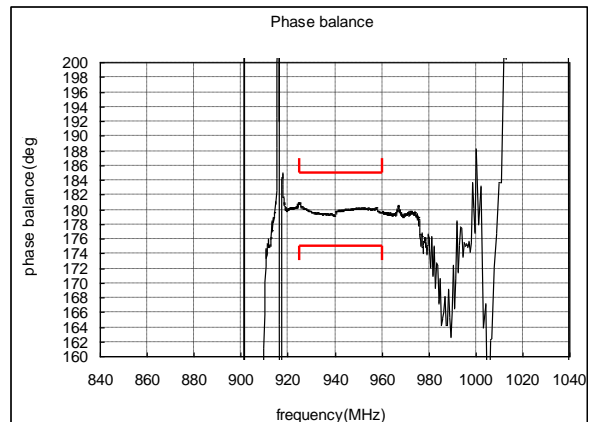

SAW FILTER FOR GSM850/GSM900 (Rx)

Murata part number : SAWEP881MCQ0F00

Dimensions of Carrier Tape

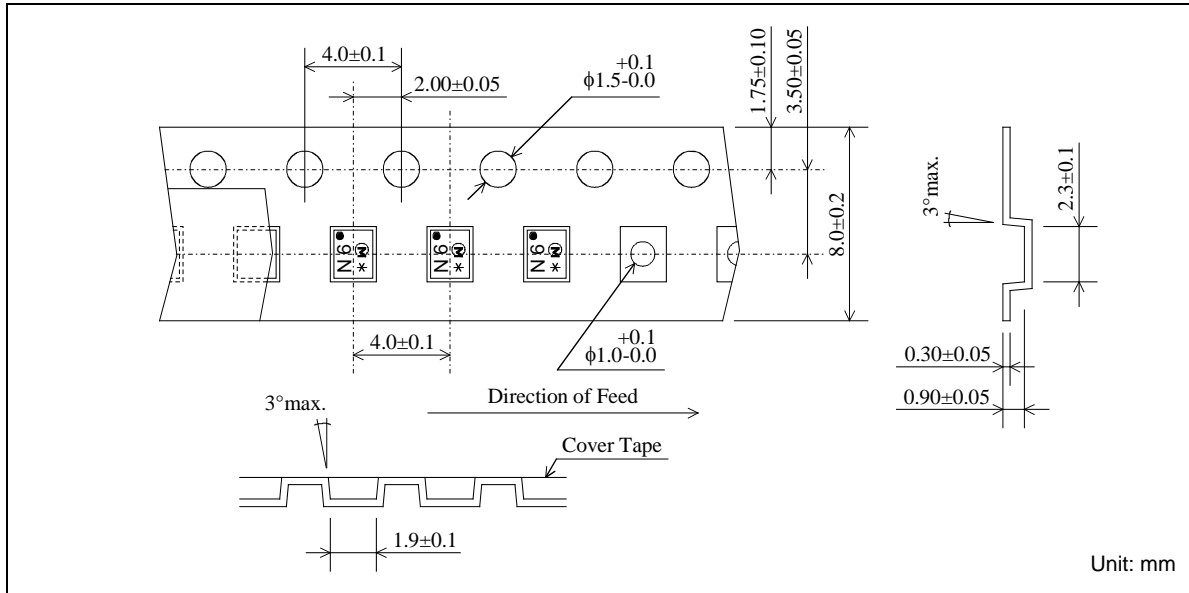

Dimensions of Tape

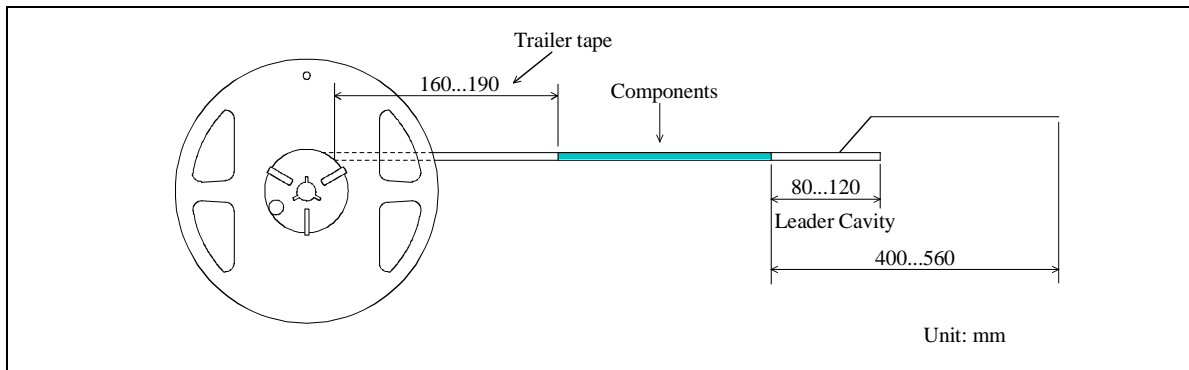

Dimensions of Reel

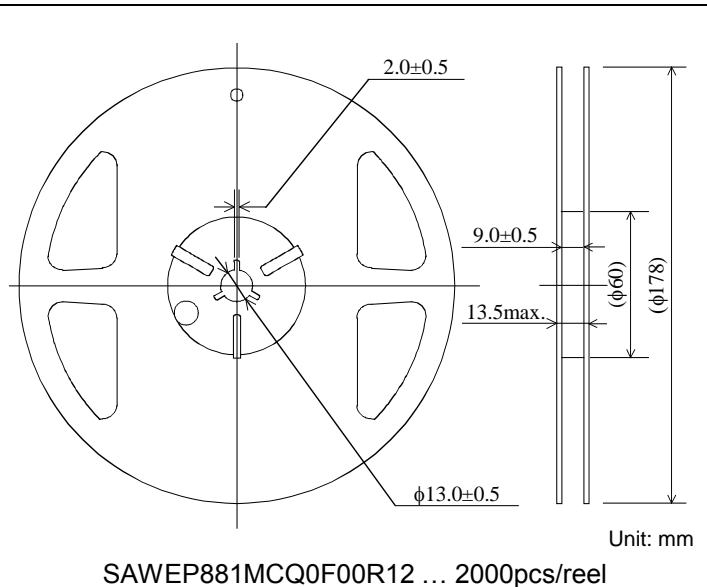
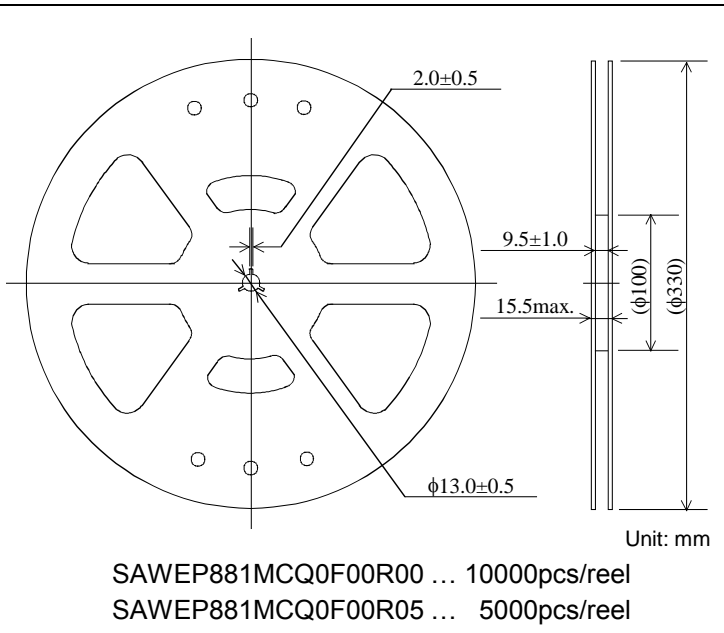

SAW FILTER FOR GSM850/GSM900 (Rx)

Murata part number : SAWEP881MCQ0F00

Recommended Land Pattern

Top View

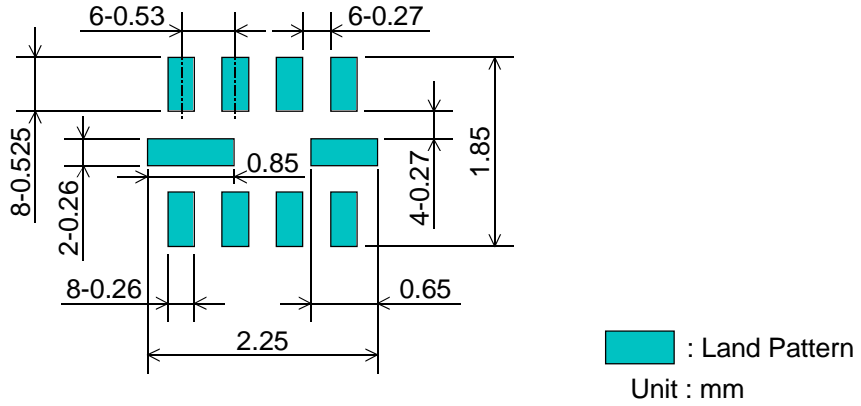

Test Circuit

Bottom View

881.5MHz

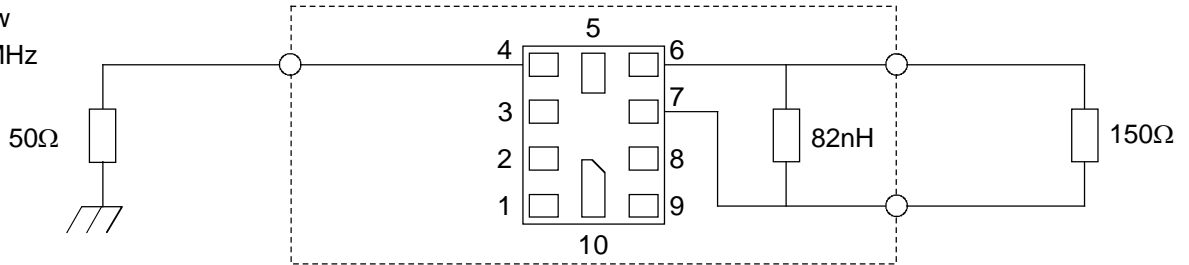

942.5MHz

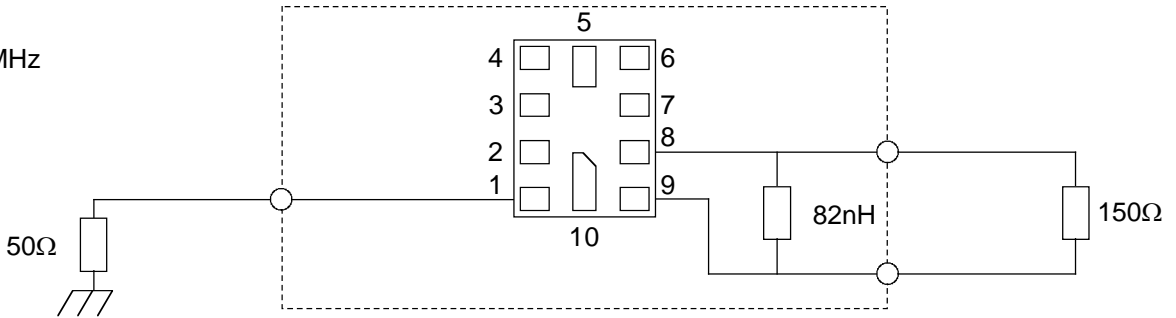

SAW FILTER FOR GSM850/GSM900 (Rx)

Murata part number : SAWEP881MCQ0F00

■ RoHS Compliance

This component is compliant with RoHS directive.

This component was always RoHS compliant from the first date of manufacture.

• Caution - Limitation of Applications

This product is intended for the following applications only; however, please do not use this product in these applications where defects might directly cause damage to a third party's life, body or property.

- a. Mobile Telephone
- b. Cordless phone (except for Automotive use)
- c. PC (Including Notebook PC, Netbook PC, Tablet)
- d. Game
- e. Camera (except for Business/security use)
- f. Set Top Box
- g. Electronic dictionary
- h. Digital audio equipment

• This catalog is for reference only and not an official product specification document, therefore, please review and approve our official product specification before ordering this product.