



Data Sheet of SAW Components



Note : Murata SAW Component is applicable for Cellular /Cordless phone (Terminal) relevant market only.

Please also read caution at the end of this document.

SAW FILTER FOR GSM850/1900 Rx

Murata part number : SAWEN881MCM2F00 (fc=881.5MHz)

Package Dimensions

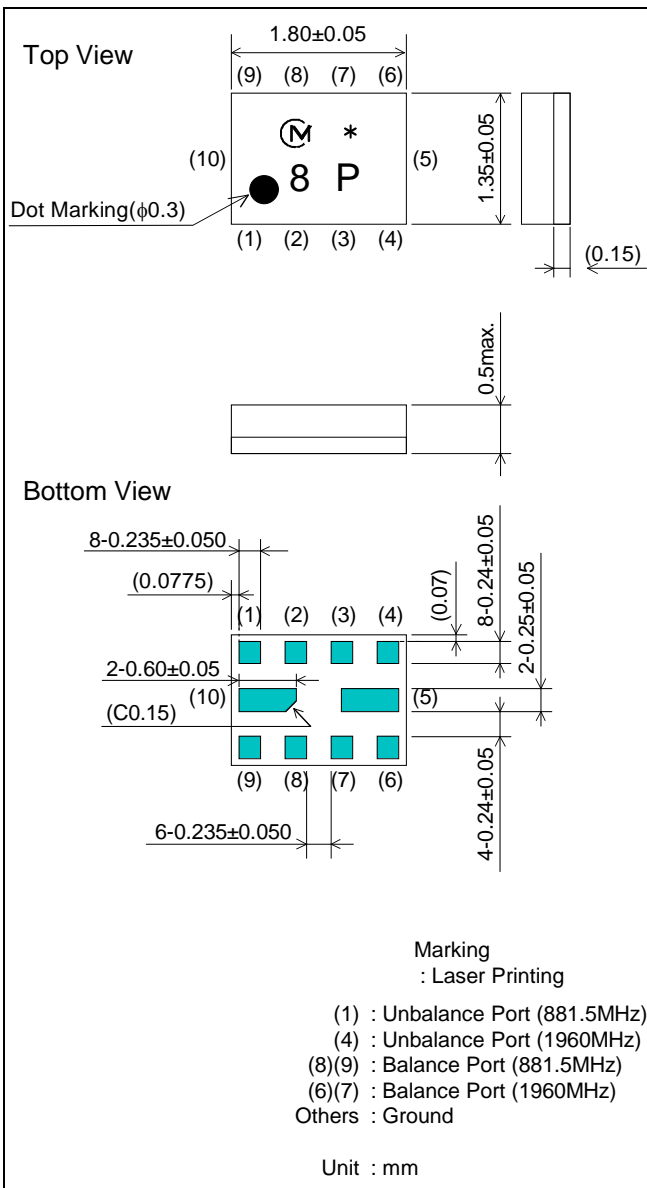

Specification

Item	Specification		
	-30 to 85°C	25±2°C	typ.
Nominal Center Frequency(fc)	881.5MHz		
Insertion Loss (869 to 894MHz)	2.0dB max.	1.9dB max.	1.4 dB
Absolute Attenuation			
1) 0.1 to 800 MHz	50 dB min.	50 dB min.	64 dB
2) 800 to 824 MHz	50 dB min.	50 dB min.	63 dB
3) 824 to 849 MHz	35 dB min.	38 dB min.	47 dB
4) 914 to 970 MHz	23 dB min.	23 dB min.	27 dB
5) 970 to 2400 MHz	35 dB min.	35 dB min.	54 dB
6) 2400 to 6000 MHz	30 dB min.	30 dB min.	46 dB
Ripple Deviation (869 to 894MHz)	1.1dB max.	0.9dB max.	0.3 dB
VSWR (869 to 894MHz)	2.0 max.	1.9 max.	1.4
Amplitude Balance (869 to 894MHz)	±0.8dB max.	±0.8dB max.	-0.2dB
Phase Balance (869 to 894MHz)	180±5deg. max.	180±5deg. max.	180+1.7deg.
Unbalance Port Matching Impedance (nominal)	50Ω		
Balance Port Matching Impedance (nominal)	150Ω//82nH		
Input Signal Level	31.6mW(+15dBm),2000 hours		

SAW FILTER FOR GSM850/1900 Rx

Murata part number : SAWEN881MCM2F00 ($f_c=881.5\text{MHz}$)

Frequency Performance

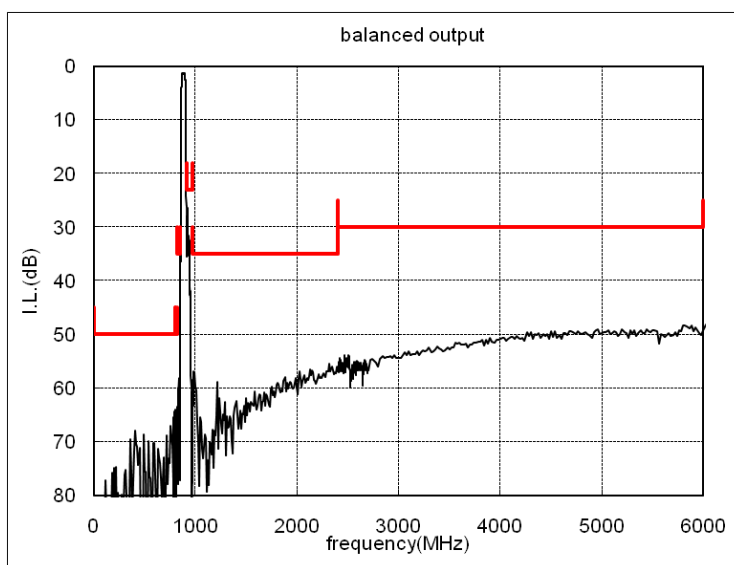
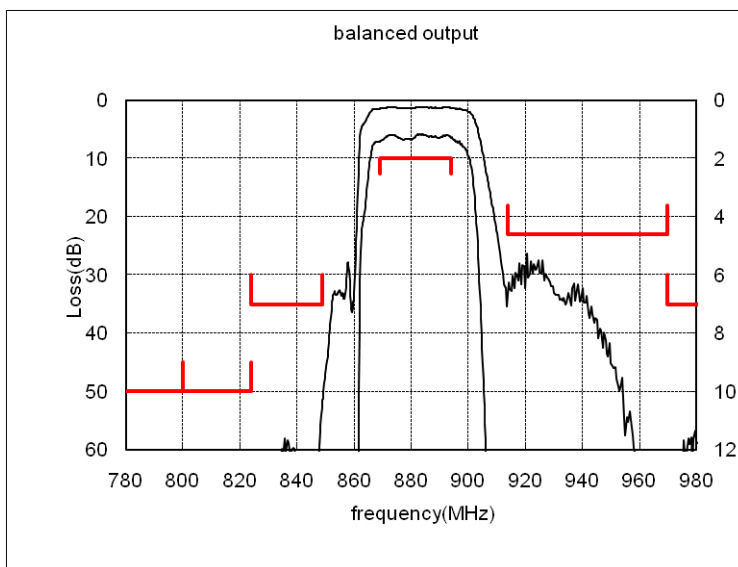

Amplitude balance

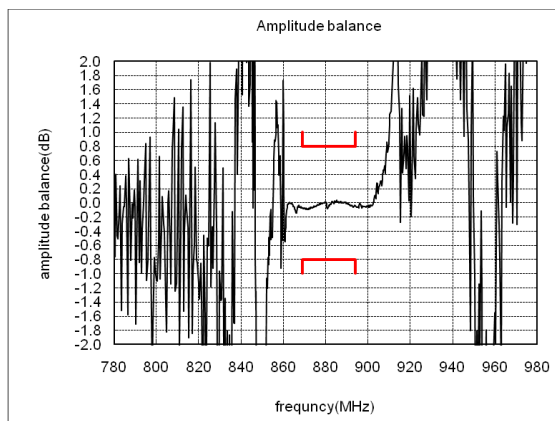

Phase balance

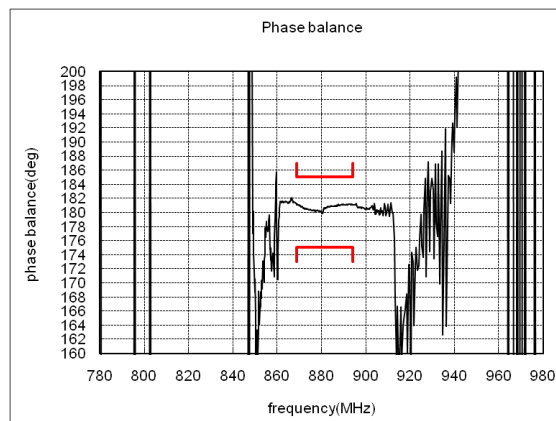

SAW FILTER FOR GSM850/1900 Rx

Murata part number : SAWEN881MCM2F00 ($f_c=1960\text{MHz}$)

Package Dimensions

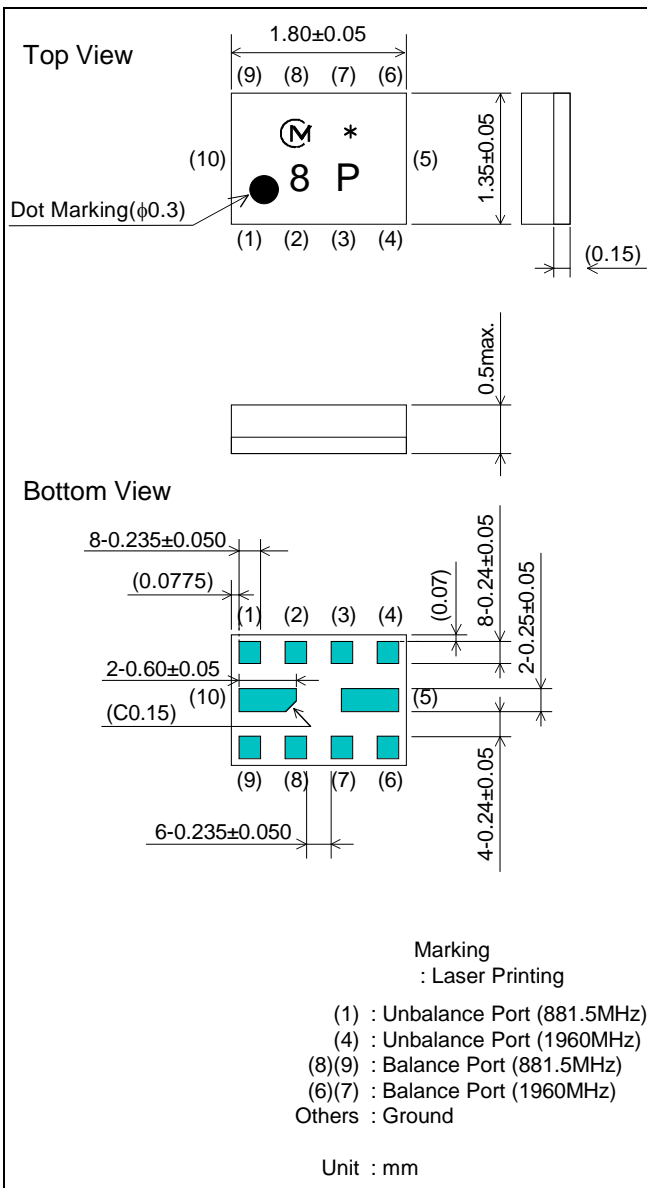

Specification

Item	Specification		
	-30 to 85°C	25±2°C	typ.
Nominal Center Frequency(f_c)	1960MHz		
Insertion Loss (1930 to 1990MHz)	2.6dB max.	2.0dB max.	1.5 dB
Absolute Attenuation			
1) 0.1 to 1830 MHz	23 dB min.	23 dB min.	33 dB
2) 1830 to 1910 MHz	11 dB min.	11 dB min.	14 dB
3) 2010 to 2070 MHz	6 dB min.	12 dB min.	14 dB
4) 2070 to 3000 MHz	20 dB min.	20 dB min.	26 dB
5) 3000 to 5700 MHz	30 dB min.	30 dB min.	36 dB
6) 5700 to 5970 MHz	30 dB min.	30 dB min.	35 dB
6) 5970 to 6000 MHz	30 dB min.	30 dB min.	36 dB
Ripple Deviation (1930 to 1990MHz)	1.8dB max.	1.0dB max.	0.5 dB
VSWR (1930 to 1990MHz)	2.2 max.	2.0 max.	1.7
Amplitude Balance (1930 to 1990MHz)	±2.0dB max.	±1.8dB max.	+0.8dB
Phase Balance (1930 to 1990MHz)	180±12deg. max.	180±12deg. max.	180-5deg.
Unbalance Port Matching Impedance (nominal)	50Ω		
Balance Port Matching Impedance (nominal)	150Ω//22nH		
Input Signal Level	20mW(+13dBm),2000 hours		

SAW FILTER FOR GSM850/1900 Rx

Murata part number : SAWEN881MCM2F00 (fc=1960MHz)

Frequency Performance

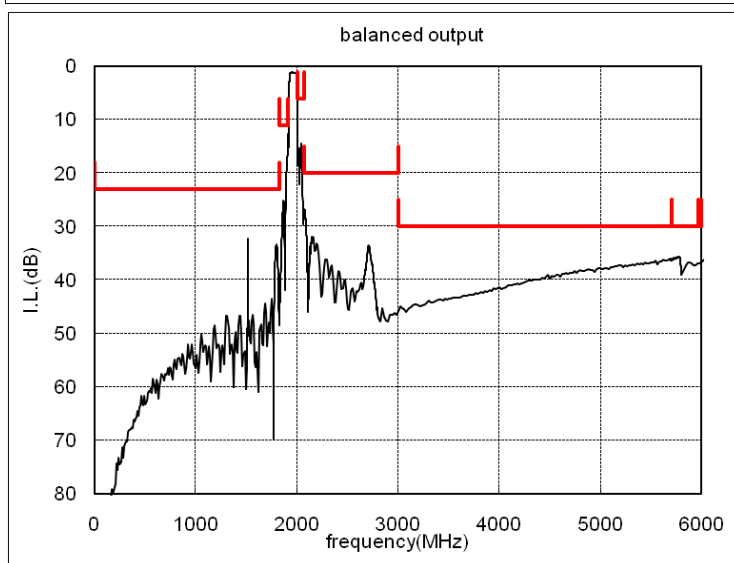
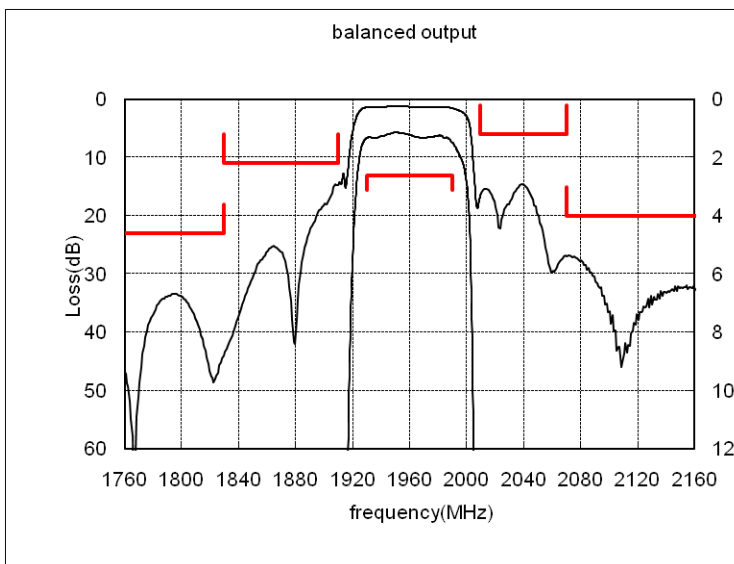

Amplitude balance

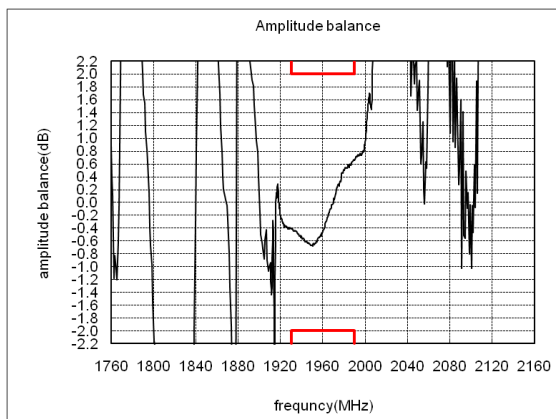

Phase balance

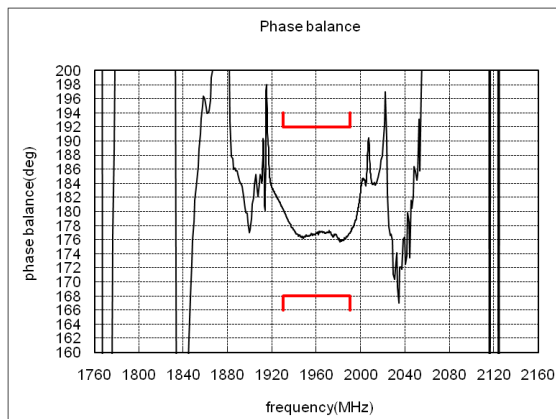

SAW FILTER FOR GSM850/1900 Rx

Murata part number : SAWEN881MCM2F00

Dimensions of Carrier Tape

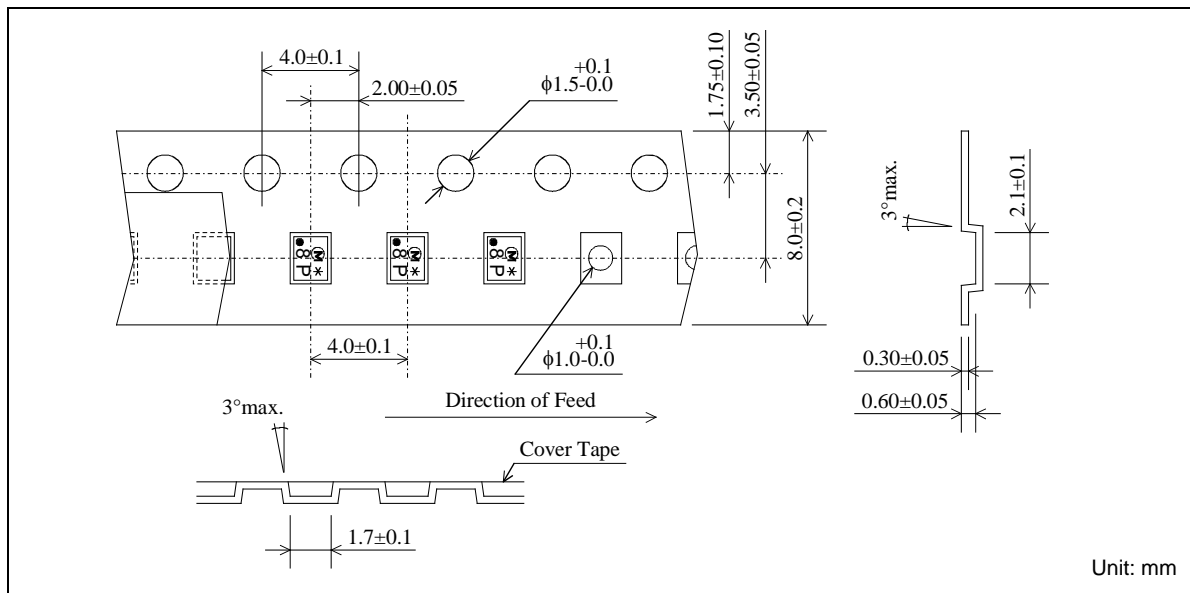

Dimensions of Tape

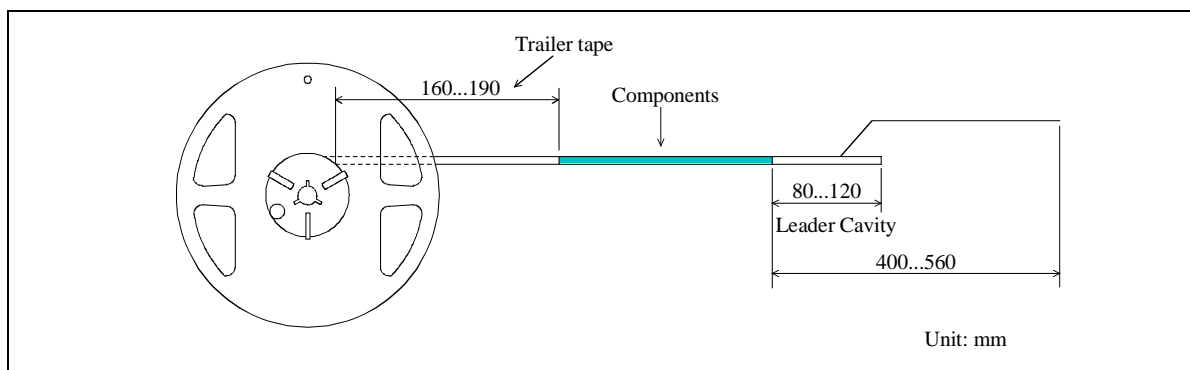

Dimensions of Reel

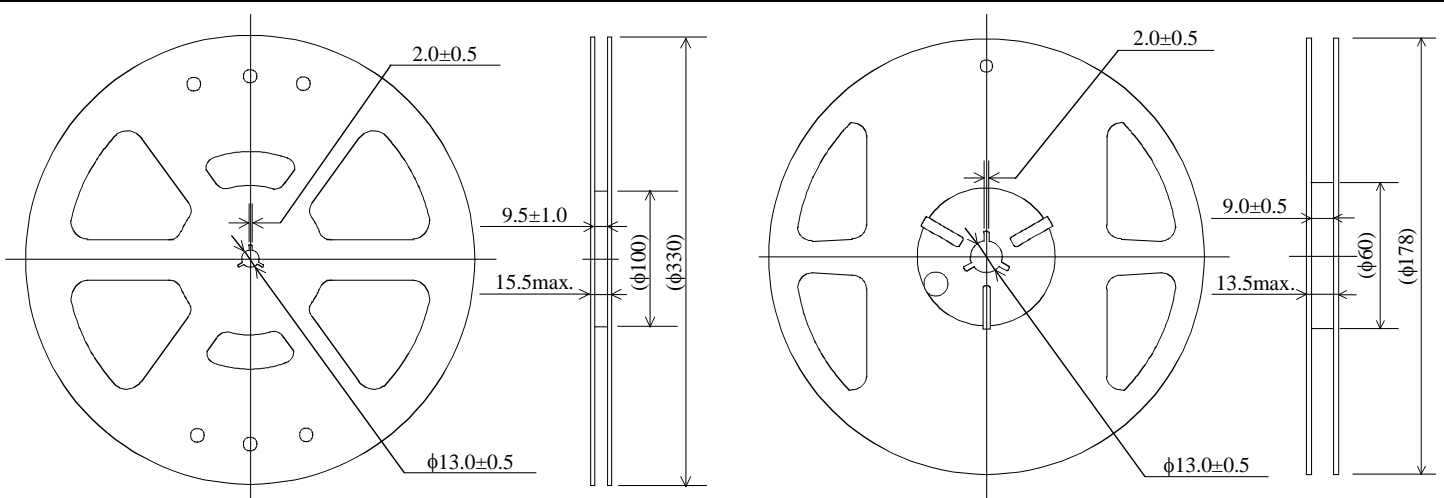

SAWEN881MCM2F00R00 ... 10000pcs/reel

SAWEN881MCM2F00R15 ... 5000pcs/reel

Unit: mm

SAW FILTER FOR GSM850/1900 Rx

Murata part number : SAWEN881MCM2F00

Recommended Land Pattern

Top View

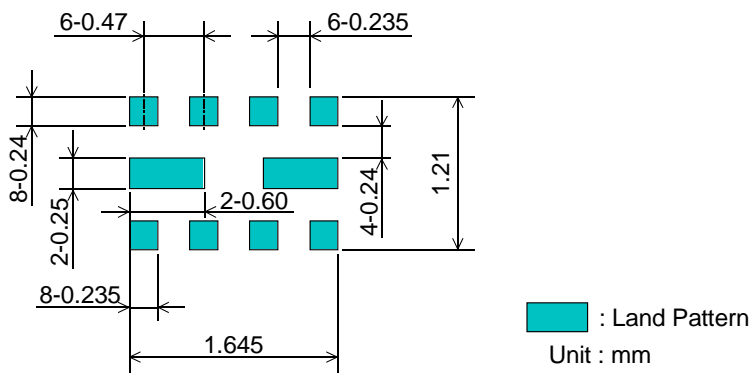

Test Circuit

Bottom View

881.5MHz

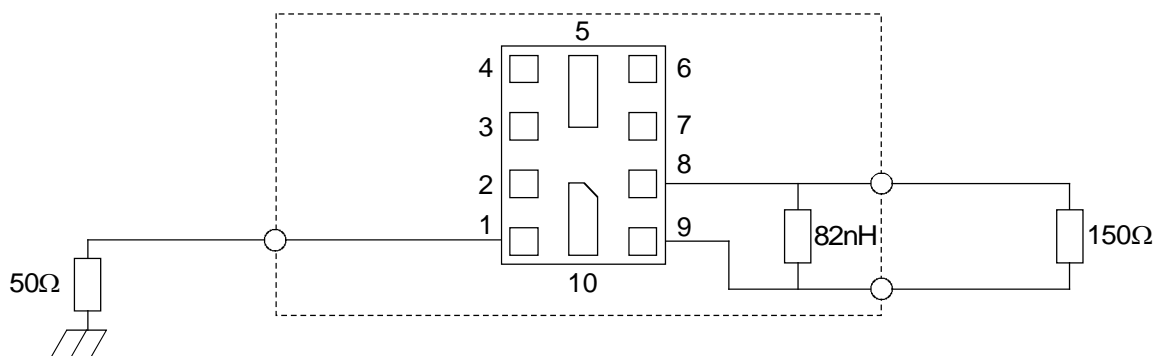

1960MHz

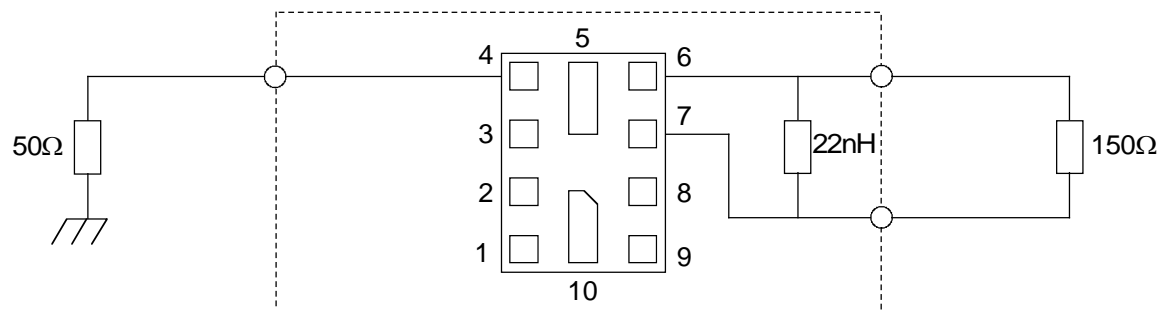

SAW FILTER FOR GSM850/1900 Rx

Murata part number : SAWEN881MCM2F00

■ RoHS Compliance

This component is compliant with RoHS directive.

This component was always RoHS compliant from the first date of manufacture.

• Caution - Limitation of Applications

This product is intended for the following applications only; however, please do not use this product in these applications where defects might directly cause damage to a third party's life, body or property.

- a. Mobile Telephone
- b. Cordless phone (except for Automotive use)
- c. PC (Including Notebook PC, Netbook PC, Tablet)
- d. Game
- e. Camera (except for Business/security use)
- f. Set Top Box
- g. Electronic dictionary
- h. Digital audio equipment

• This catalog is for reference only and not an official product specification document, therefore, please review and approve our official product specification before ordering this product.