

# SAW DPX FOR IMT 1.7G

Murata part number :SAYZX1G76AB0F00 [Tx→ANT]

## Package Dimensions

## Specification

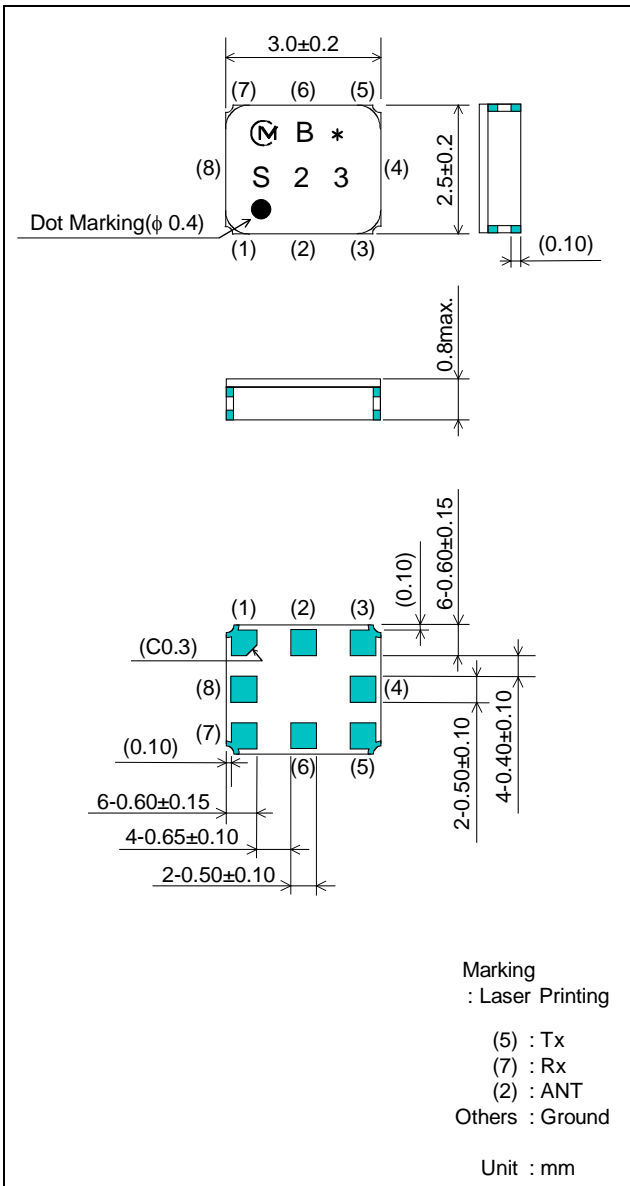

Item	Specification	
	-30 to 85°C	typ.
Nominal Center Frequency(fc)	1767.45MHz	
Insertion Loss (1749.9 to 1785MHz)	1.75 dB max.	1.39 dB
Absolute Attenuation		
1) 470 to 770 MHz	30 dB min.	36 dB
2) 810 to 960 MHz	20 dB min.	32 dB
3) 1477 to 1516 MHz	15 dB min.	25 dB
4) 1573 to 1577 MHz	20 dB min.	25 dB
5) 1844.9 to 1880 MHz	37 dB min.	47 dB
6) 1884 to 1920 MHz	20 dB min.	31 dB
7) 2110 to 2170 MHz	20 dB min.	27 dB
8) 3499 to 3570 MHz	25 dB min.	35 dB
9) 5249 to 5355 MHz	15 dB min.	24 dB
Ripple Deviation (1749.9 to 1785MHz)	0.8 dB max.	0.5 dB
VSWR (1749.9 to 1785MHz)	1.8 max.	1.5
ANT Port Matching Impedance(nominal)	50Ω/3.3nH	
Tx Port Matching Impedance(nominal)	50Ω	
Rx Port Matching Impedance(nominal)	50Ω	
Input Signal Level	1.0W,50000 hours (50°C)	

# SAW DPX FOR IMT 1.7G

Murata part number :SAYZX1G76AB0F00 [Tx→ANT]

## Frequency Performance

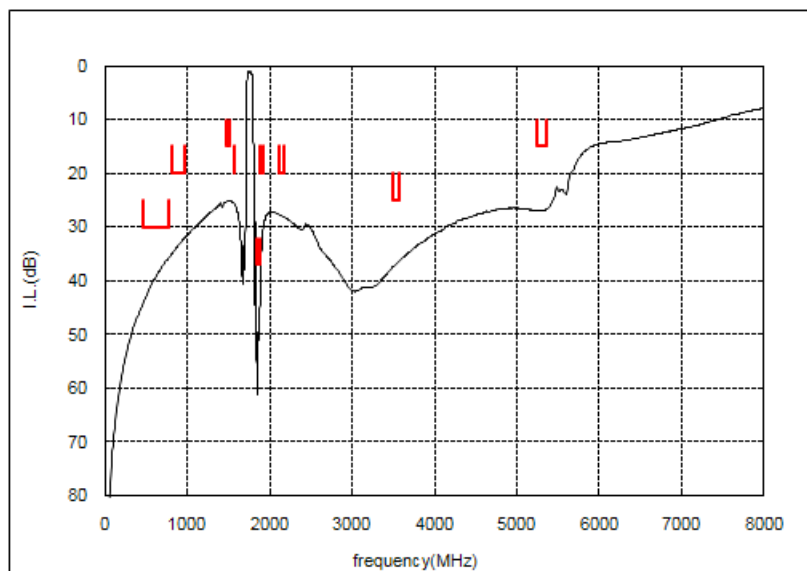
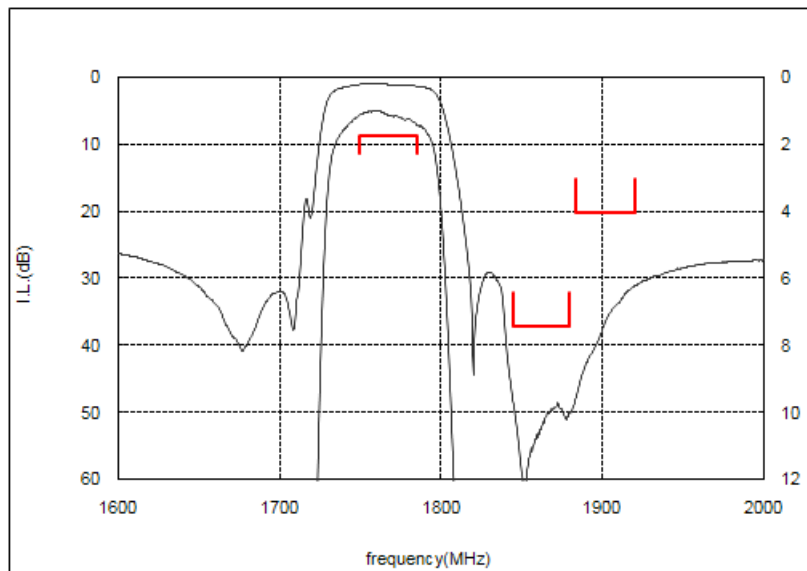

# SAW DPX FOR IMT 1.7G

Murata part number :SAYZX1G76AB0F00 [ANT→Rx]

## Package Dimensions

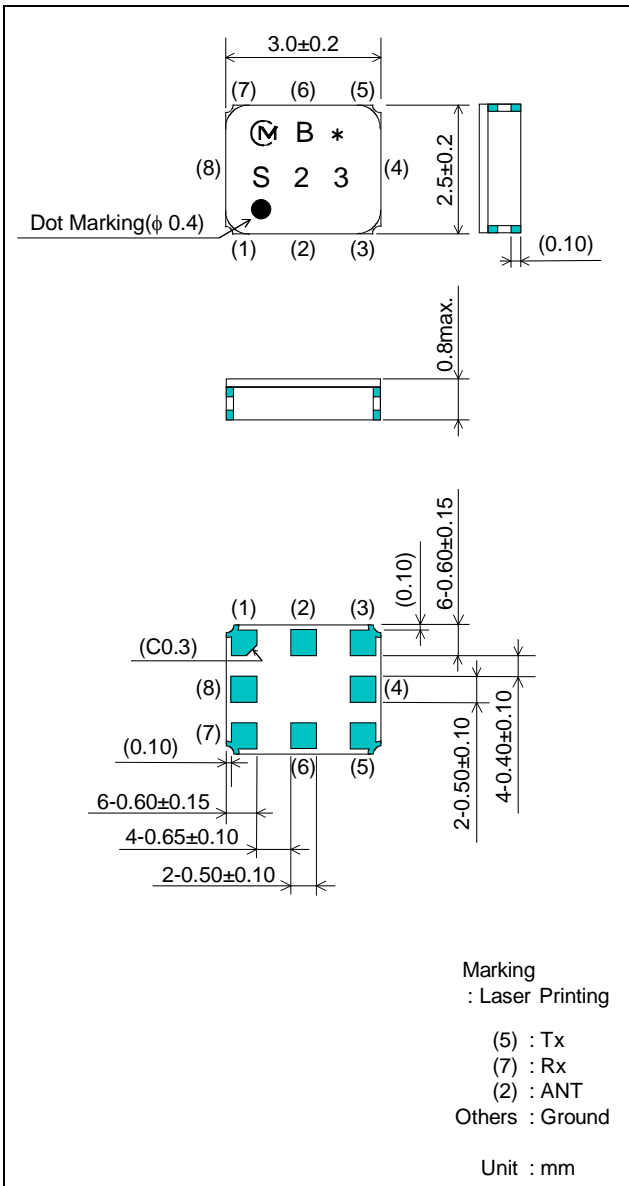

## Specification

Item	Specification	
	-30 to 85°C	typ.
Nominal Center Frequency(fc)	1862.45MHz	
Insertion Loss (1844.9 to 1880MHz)	2.3 dB max.	2.1 dB
Absolute Attenuation		
1) 90 to 100 MHz	50 dB min.	84 dB
2) 922.4 to 940 MHz	30 dB min.	49 dB
3) 1654 to 1690 MHz	37 dB min.	45 dB
4) 1749.9 to 1785 MHz	47 dB min.	54 dB
5) 3404 to 3475 MHz	30 dB min.	45 dB
6) 3594 to 3665 MHz	35 dB min.	42 dB
7) 3689 to 3760 MHz	25 dB min.	40 dB
8) 5344 to 5450 MHz	32 dB min.	44 dB
9) 5534 to 5640 MHz	25 dB min.	42 dB
10) 7379 to 7520 MHz	20 dB min.	35 dB
Ripple Deviation (1844.9 to 1880MHz)	1 dB max.	0.6 dB
VSWR (1844.9 to 1880MHz)	2.0 max.	1.5
ANT Port Matching Impedance(nominal)	50Ω//3.3nH	
Tx Port Matching Impedance(nominal)	50Ω	
Rx Port Matching Impedance(nominal)	50Ω	

# SAW DPX FOR IMT 1.7G

Murata part number :SAYZX1G76AB0F00 [ANT→Rx]

## Frequency Performance

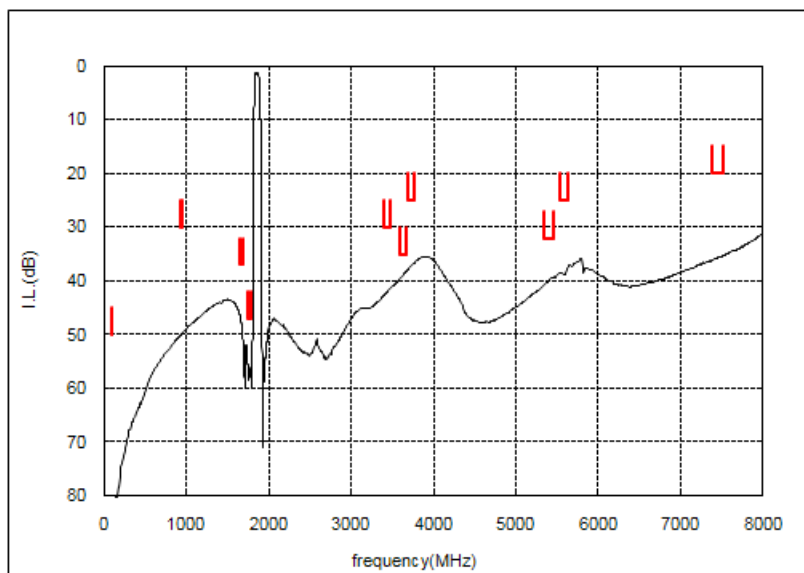
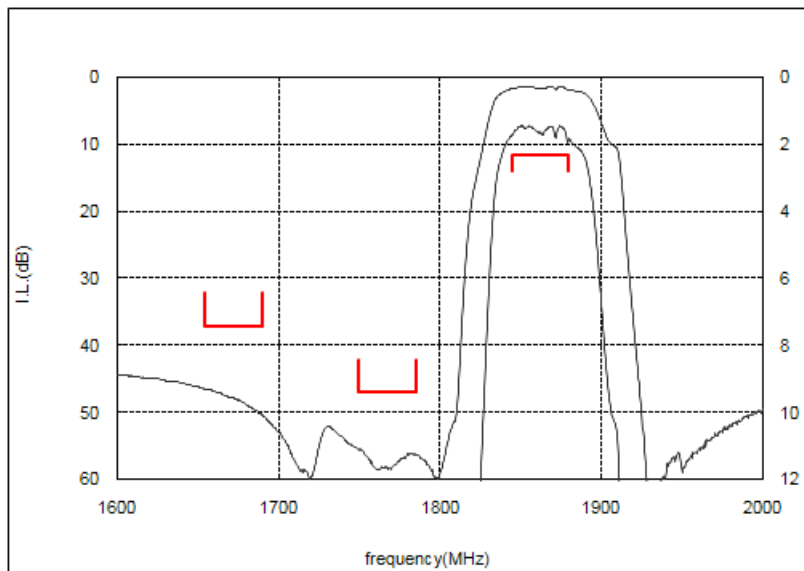

# SAW DPX FOR IMT 1.7G

Murata part number :SAYZX1G76AB0F00 [Tx → Rx]

## Package Dimensions

## Specification

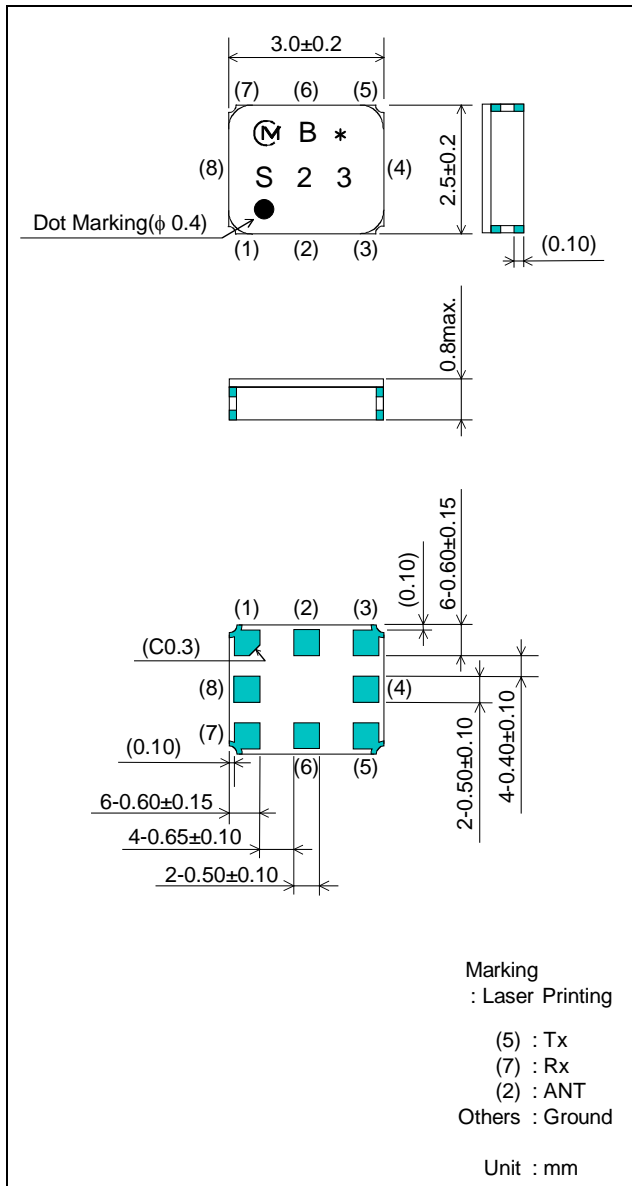

Item	Specification	
	-30 to 85°C	typ.
Isolation		
1) 1749.9 to 1785 MHz	51 dB min.	56 dB
2) 1844.9 to 1880 MHz	40 dB min.	42 dB

# SAW DPX FOR IMT 1.7G

Murata part number :SAYZX1G76AB0F00 [Tx→Rx]

## Frequency Performance

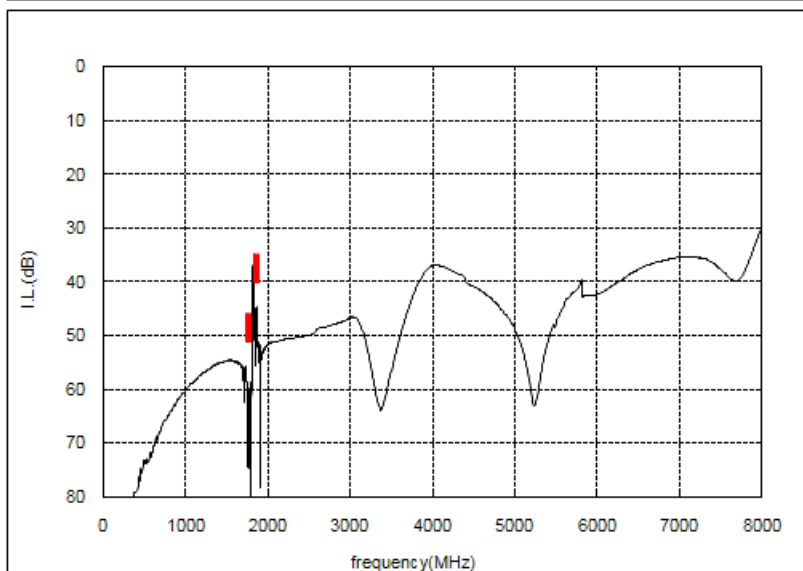
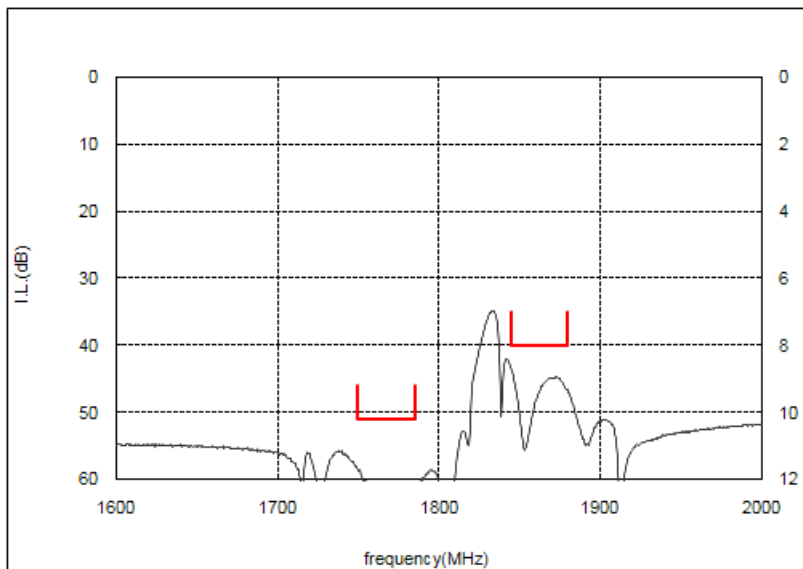

# SAW DPX FOR IMT 1.7G

Murata part number :SAYZX1G76AB0F00

## Dimensions of Carrier Tape

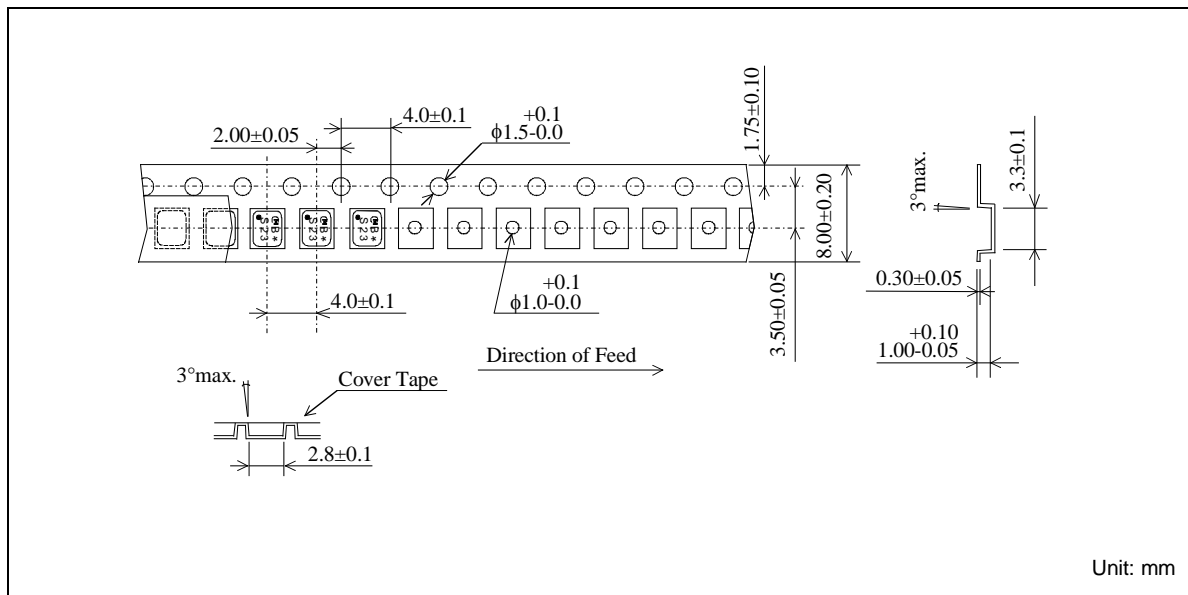

## Dimensions of Tape

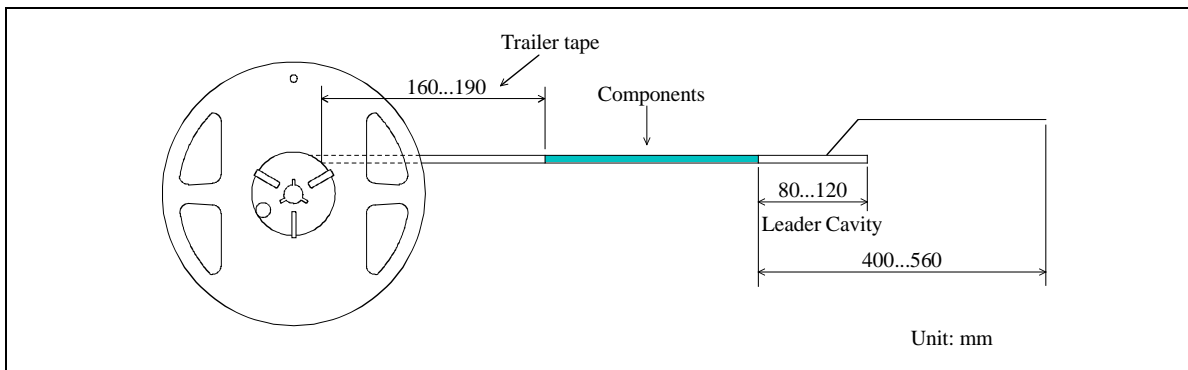

## Dimensions of Reel

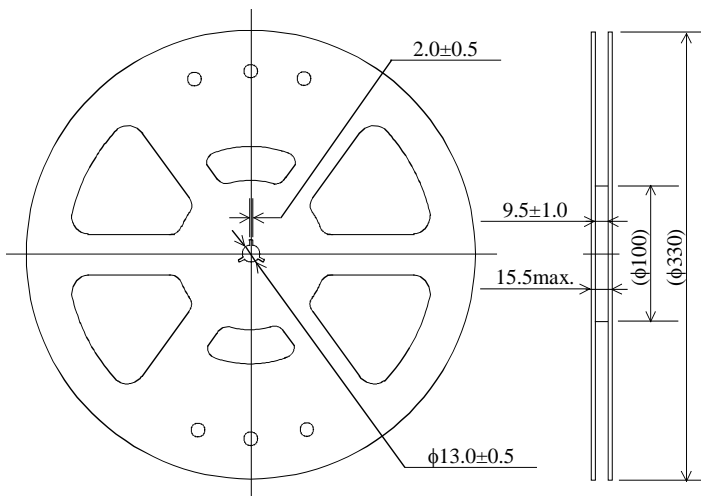

SAYZX1G76AB0F00R00 ... 10000pcs/reel  
SAYZX1G76AB0F00R05 ... 5000pcs/reel

# SAW DPX FOR IMT 1.7G

Murata part number :SAYZX1G76AB0F00

## Recommended Land Pattern

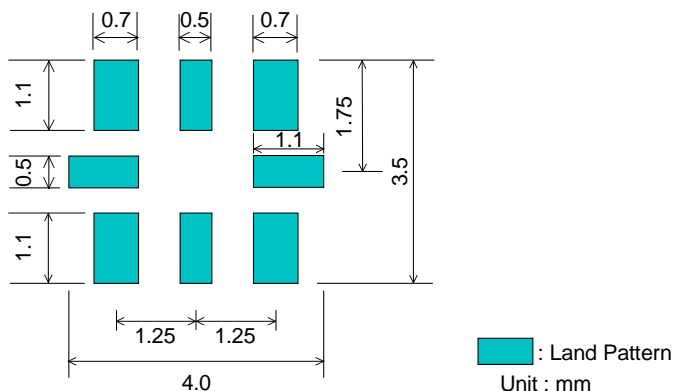

## Test Circuit

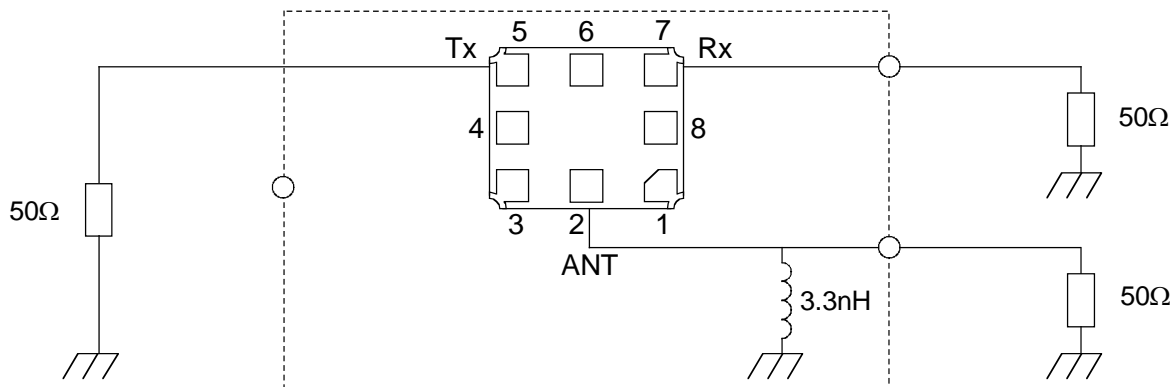

- This PDF Datasheet is downloaded from the website of Murata Manufacturing Co., Ltd. Therefore, it's specifications are subject to change or our products in it may be discontinued without advance notice. Please check with our sales representatives or product engineers before ordering.
- This PDF Datasheet has only typical specifications because there is no space for detailed specifications. Therefore, please approve our product specifications or transact the approval sheet for product specifications before ordering.