



Data Sheet of SAW Components



Note : Murata SAW Component is applicable for Cellular /Cordless phone (Terminal) relevant market only.

Please also read caution at the end of this document.

SAW FILTER FOR GSM850/GSM1900 (Rx)

Murata part number : SAWEP881MCN2F00 (fc=881.5MHz)

Package Dimensions

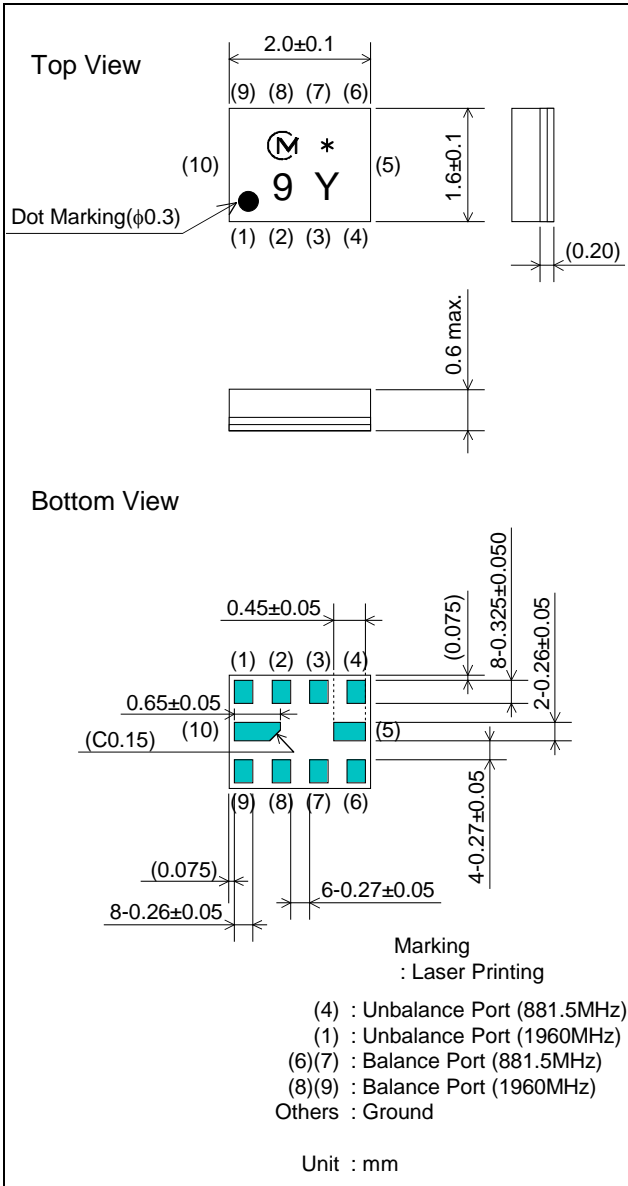

Specification

Item	Specification			
	-30 to 85°C	-10 to 80°C	25±2°C	typ.
Nominal Center Frequency(fc)	881.5 MHz			
Insertion Loss (869 to 894MHz)	2.3 dB max.	2.0 dB max.	1.9 dB max.	1.4 dB
Absolute Attenuation				
1) 100 to 800 MHz	50 dB min.	50 dB min.	50 dB min.	63 dB
2) 800 to 824 MHz	45 dB min.	45 dB min.	45 dB min.	62 dB
3) 824 to 849 MHz	35 dB min.	35 dB min.	38 dB min.	49 dB
4) 914 to 970 MHz	23 dB min.	23 dB min.	23 dB min.	27 dB
5) 970 to 2400 MHz	40 dB min.	40 dB min.	40 dB min.	51 dB
6) 2400 to 6000 MHz	35 dB min.	35 dB min.	35 dB min.	41 dB
Ripple Deviation (869 to 894MHz)	1.2 dB max.	0.9 dB max.	0.7 dB max.	0.3 dB
VSWR (869 to 894MHz)	1.8 max.	1.7 max.	1.6 max.	1.4
Amplitude Balance (869 to 894MHz)	±1.0dB max.	±1.0dB max.	±0.5dB max.	±0.2dB
Phase Balance (869 to 894MHz)	180±10deg. max.	180±10deg. max.	180±8deg.	180±2.5deg.
Unbalance Port Matching Impedance (nominal)	50Ω			
Balance Port Matching Impedance (nominal)	150Ω//82nH			
Input Signal Level	31.6mW (+15dBm), 2000 hours			

SAW FILTER FOR GSM850/GSM1900 (Rx)

Murata part number : SAWEP881MCN2F00 ($f_c=881.5\text{MHz}$)

Frequency Performance

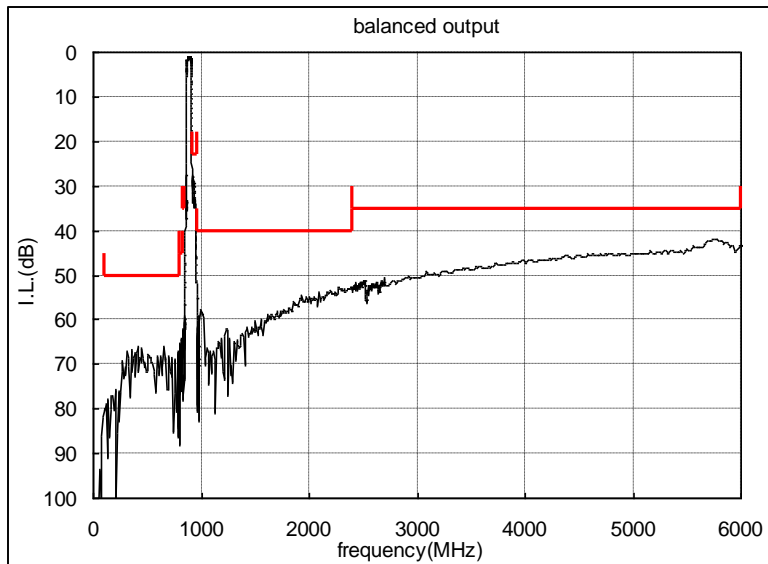
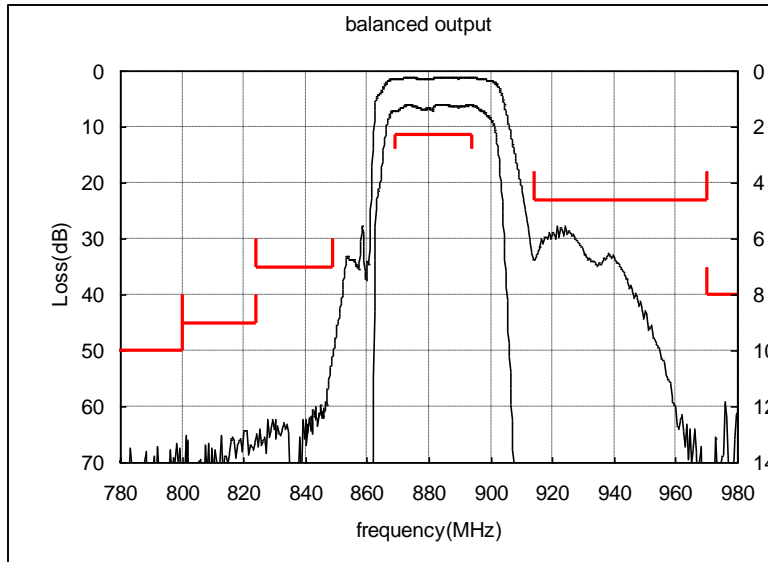

Amplitude balance

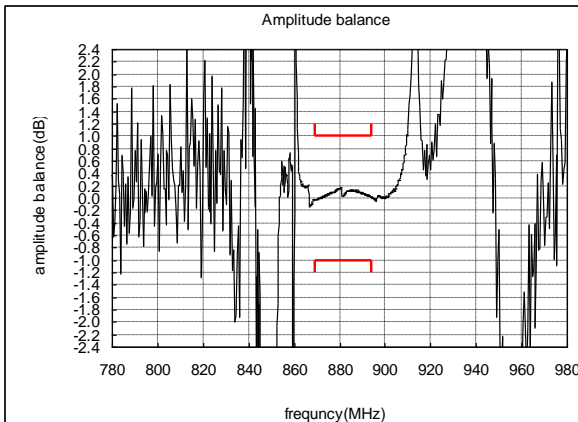

Phase balance

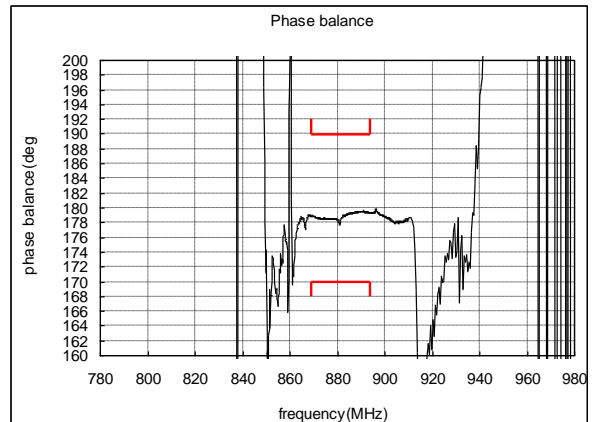

SAW FILTER FOR GSM850/GSM1900 (Rx)

Murata part number : SAWEP881MCN2F00 (fc=1960MHz)

Package Dimensions

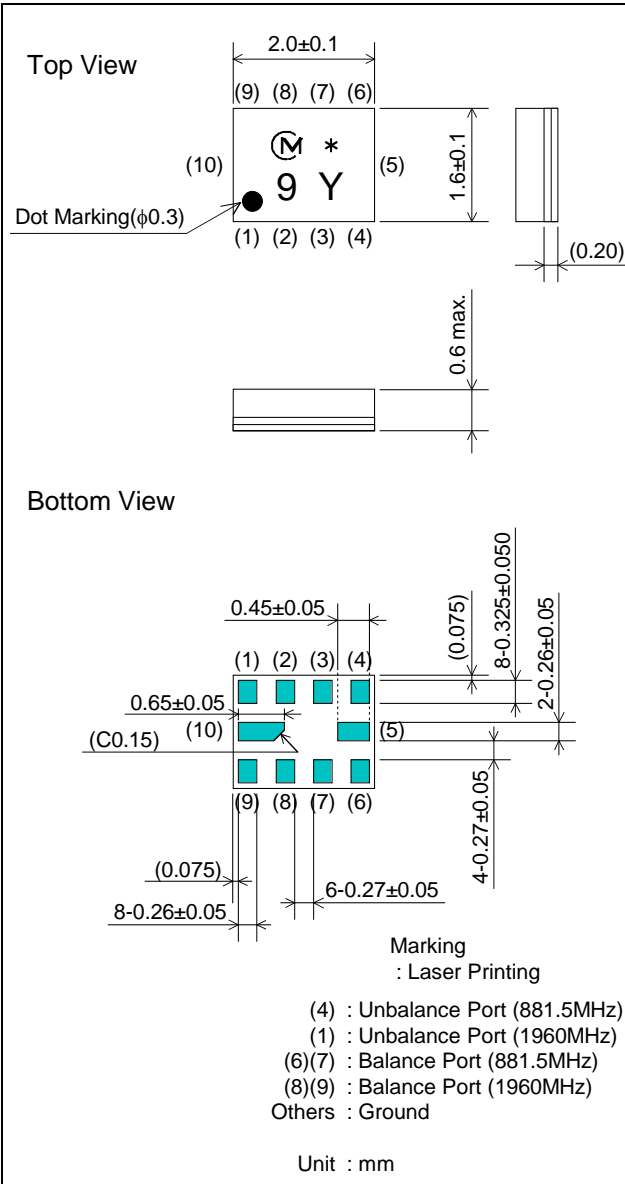

Specification

Item	Specification			
	-30 to 85°C	-10 to 80°C	25±2°C	typ.
Nominal Center Frequency (fc)	1960 MHz			
Insertion Loss (1930 to 1990MHz)	2.6 dB max.	2.5 dB max.	2.0 dB max.	1.6 dB
Absolute Attenuation				
1) 100 to 1830 MHz	23 dB min.	23 dB min.	23 dB min.	33 dB
2) 1830 to 1910 MHz	11 dB min.	11 dB min.	11 dB min.	14 dB
3) 2010 to 2070 MHz	6 dB min.	10 dB min.	12 dB min.	14 dB
4) 2070 to 3000 MHz	20 dB min.	20 dB min.	20 dB min.	24 dB
5) 3000 to 6000 MHz	30 dB min.	30 dB min.	30 dB min.	35 dB
Ripple Deviation (1930 to 1990MHz)	1.8 dB max.	1.6 dB max.	1.0 dB max.	0.4 dB
VSWR (1930 to 1990MHz)	2.2 max.	2.0 max.	1.8 max.	1.6
Amplitude Balance (1930 to 1990MHz)	±2.0dB max.	±2.0dB max.	±1.8dB max.	±1.4dB
Phase Balance (1930 to 1990MHz)	180±12deg. max.	180±12deg. max.	180±9deg.	180±6deg.
Unbalance Port Matching Impedance (nominal)	50Ω			
Balance Port Matching Impedance (nominal)	150Ω//18nH			
Input Signal Level	20mW (+13dBm), 2000 hours			

SAW FILTER FOR GSM850/GSM1900 (Rx)

Murata part number : SAWEP881MCN2F00 ($f_c=1960\text{MHz}$)

Frequency Performance

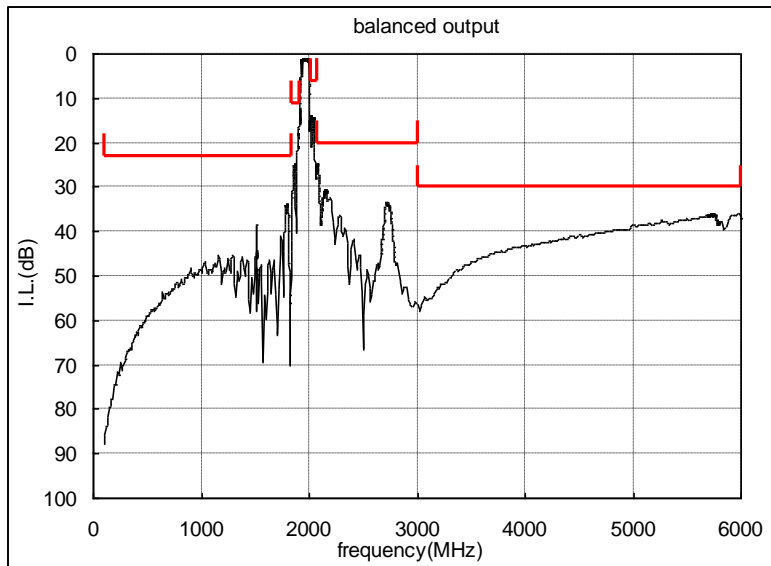
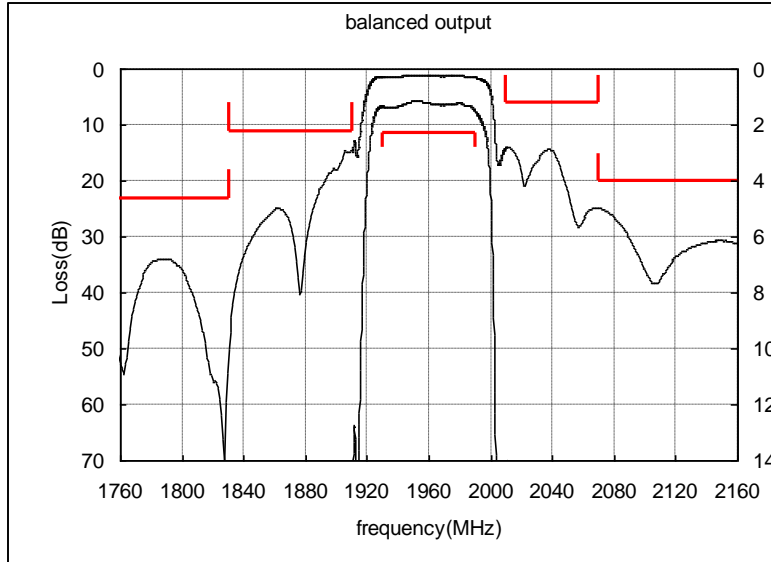

Amplitude balance

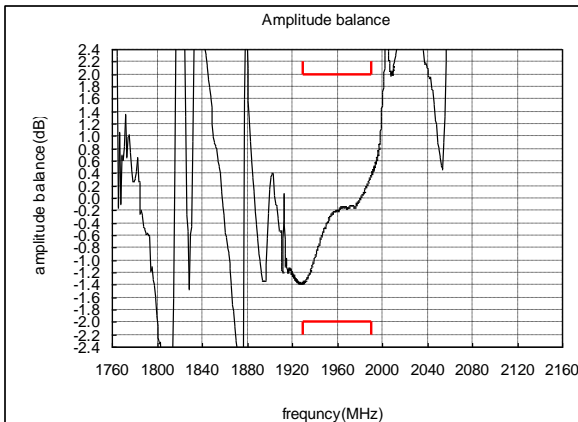

Phase balance

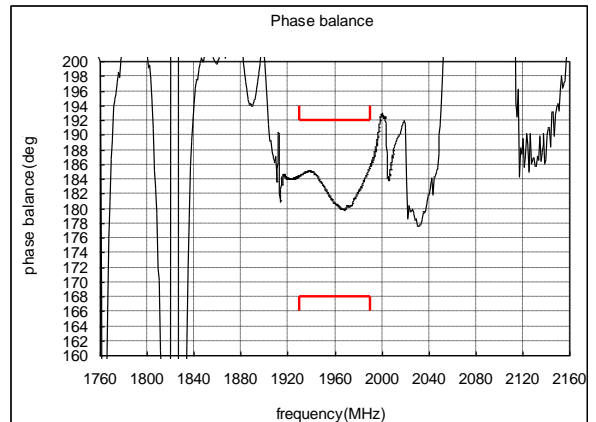

SAW FILTER FOR GSM850/GSM1900 (Rx)

Murata part number : SAWEP881MCN2F00

Dimensions of Carrier Tape

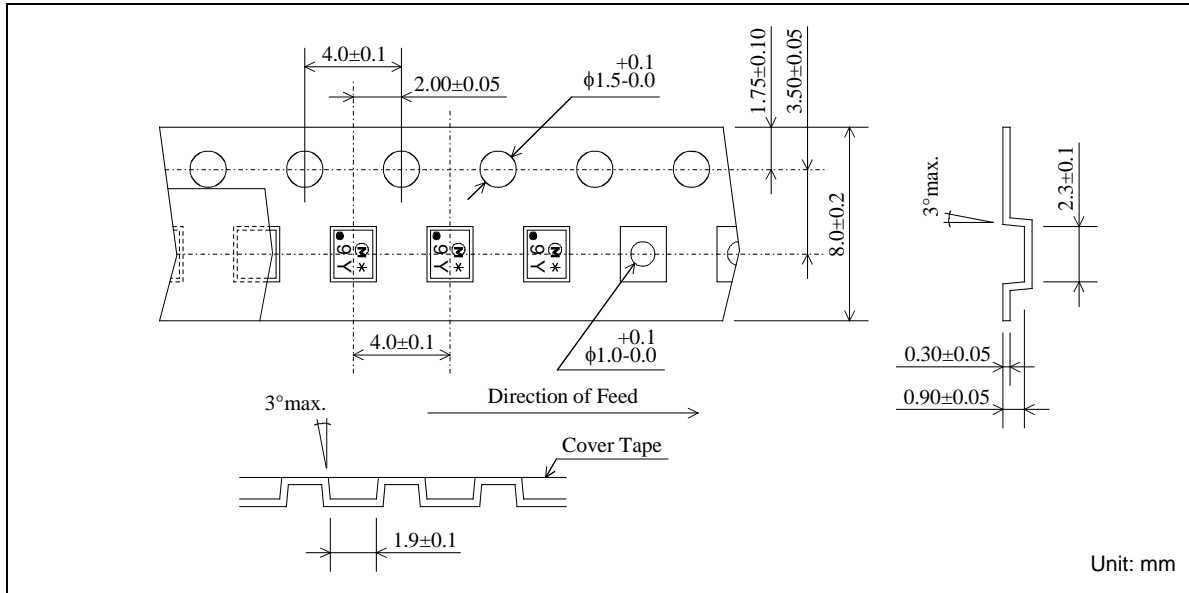

Dimensions of Tape

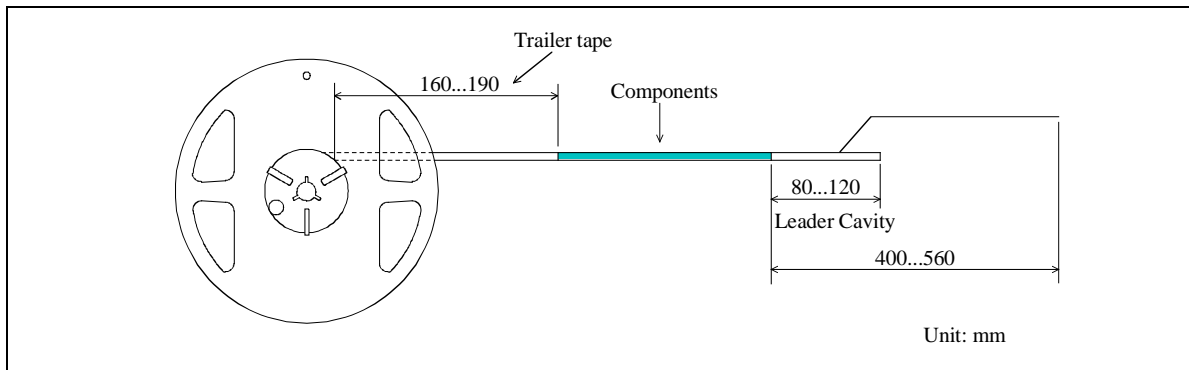

Dimensions of Reel

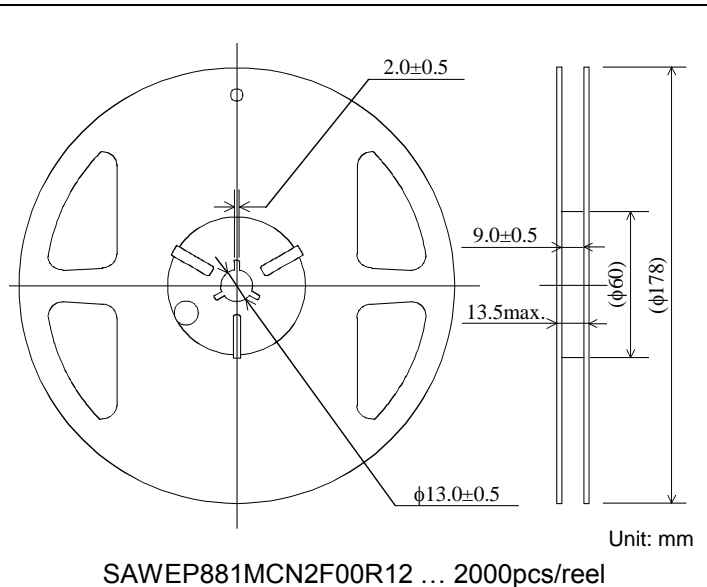
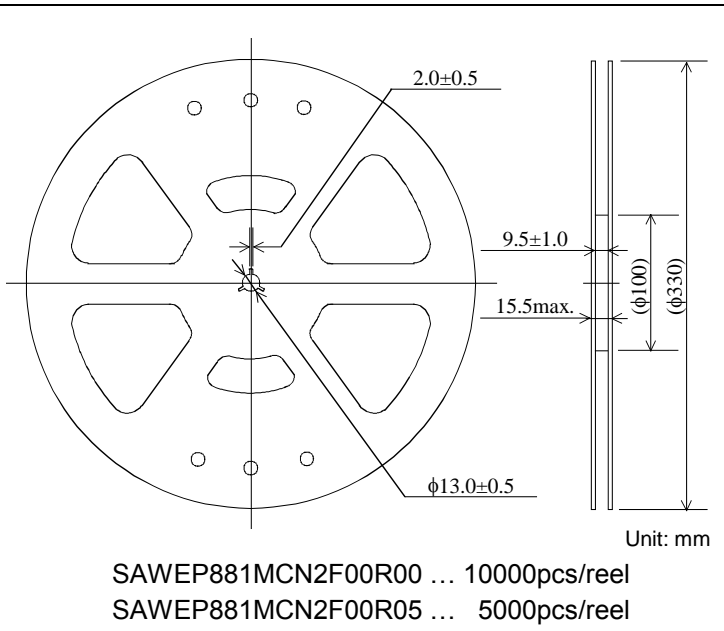

SAW FILTER FOR GSM850/GSM1900 (Rx)

Murata part number : SAWEP881MCN2F00

Recommended Land Pattern

Top View

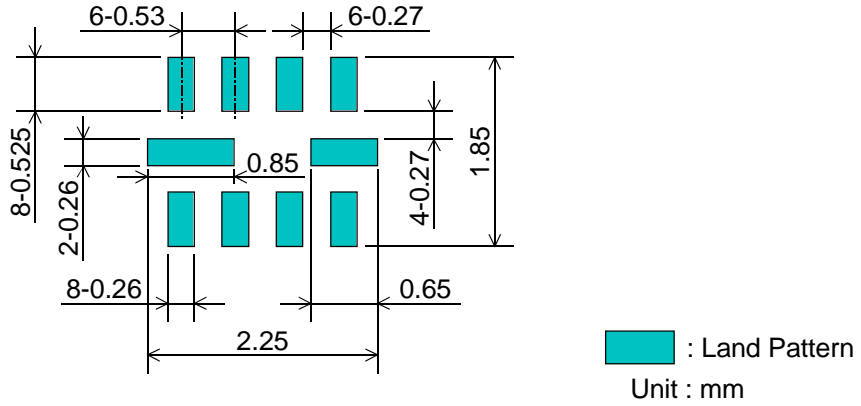

Test Circuit

Bottom View

881.5MHz

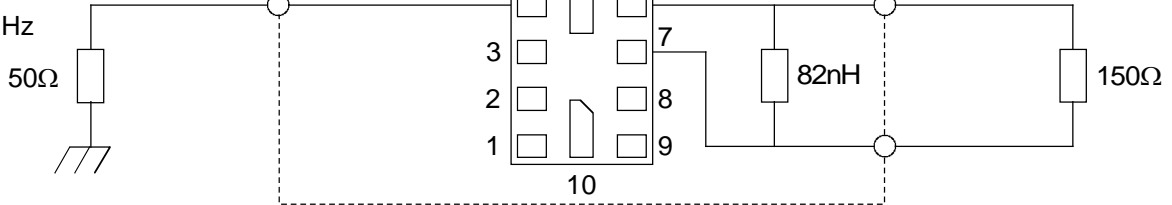

1960MHz

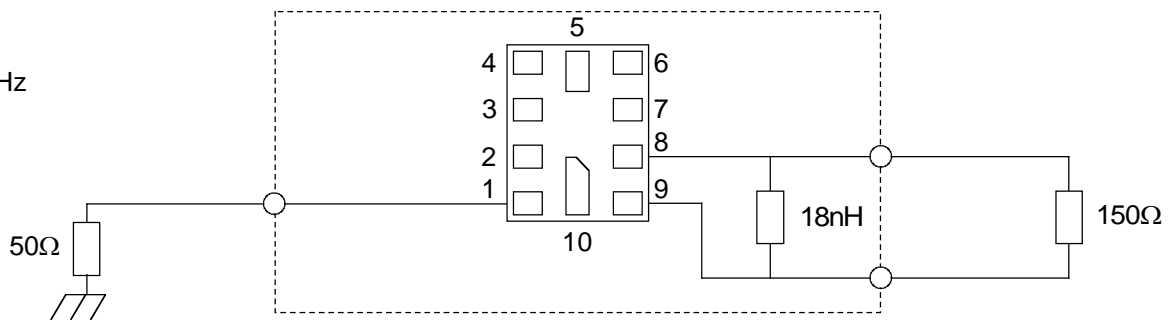

SAW FILTER FOR GSM850/GSM1900 (Rx)

Murata part number : SAWEP881MCN2F00

■ RoHS Compliance

This component is compliant with RoHS directive.

This component was always RoHS compliant from the first date of manufacture.

• Caution - Limitation of Applications

This product is intended for the following applications only; however, please do not use this product in these applications where defects might directly cause damage to a third party's life, body or property.

- a. Mobile Telephone
- b. Cordless phone (except for Automotive use)
- c. PC (Including Notebook PC, Netbook PC, Tablet)
- d. Game
- e. Camera (except for Business/security use)
- f. Set Top Box
- g. Electronic dictionary
- h. Digital audio equipment

• This catalog is for reference only and not an official product specification document, therefore, please review and approve our official product specification before ordering this product.