



Data Sheet of SAW Components



Note : Murata SAW Component is applicable for Cellular /Cordless phone (Terminal) relevant market only.

Please also read caution at the end of this document.

SAW FILTER FOR GSM1800/GSM1900 (Rx)

Murata part number : SAWEP1G84CQ0F00 (fc=1842.5MHz)

Package Dimensions

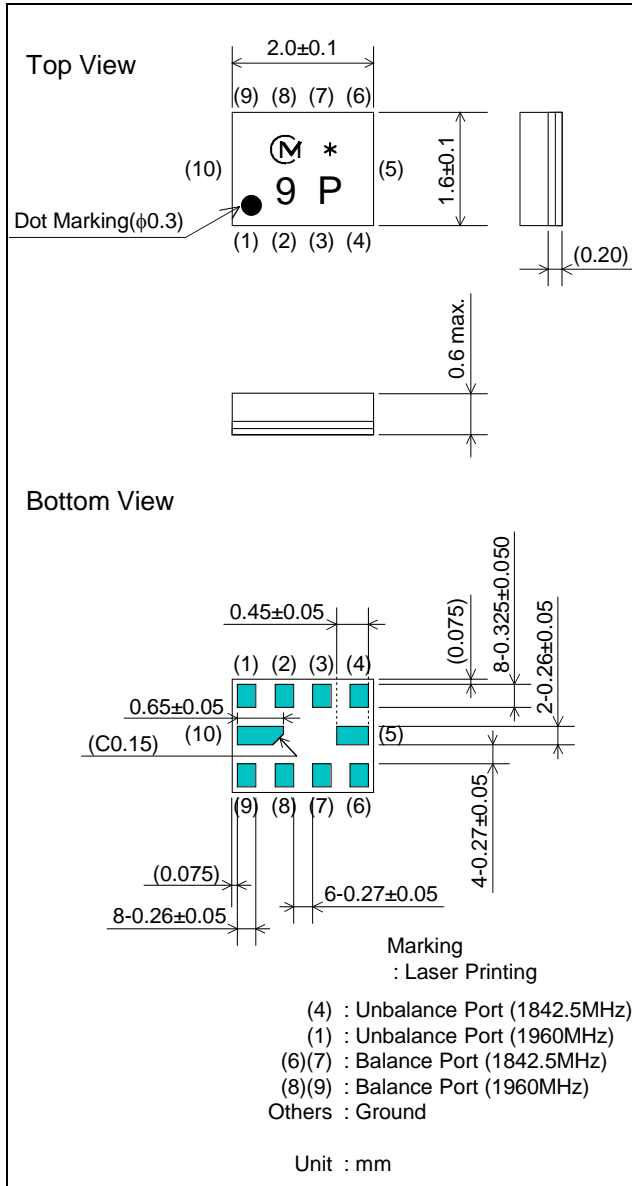

Specification

Item	Specification		
	-30 to 85°C	25±2°C	typ.
Nominal Center Frequency(fc)	1842.5MHz		
Insertion Loss (1805 to 1880MHz)	2.5 dB max.	1.8 dB max.	1.6 dB
Absolute Attenuation			
1) 0.1 to 1300 MHz	35 dB min.	35 dB min.	48 dB
2) 1300 to 1705 MHz	20 dB min.	20 dB min.	32 dB
3) 1705 to 1785 MHz	10 dB min.	13 dB min.	16 dB
4) 1920 to 1980 MHz	12 dB min.	15 dB min.	17 dB
5) 1980 to 3000 MHz	20 dB min.	20 dB min.	23 dB
6) 3000 to 4000 MHz	35 dB min.	35 dB min.	43 dB
7) 4000 to 5000 MHz	35 dB min.	35 dB min.	41 dB
8) 5000 to 6000 MHz	27 dB min.	27 dB min.	32 dB
Ripple Deviation (1805 to 1880MHz)	1.5dB max.	1.0dB max.	0.4 dB
VSWR (1805 to 1880MHz)	2.2 max.	2.1 max.	1.8
Amplitude Balance (1805 to 1880MHz)	±1.5dB max.	±1.2dB max.	±0.7dB
Phase Balance (1805 to 1880MHz)	180±12deg. max.	180±10deg. max.	180±2deg.
Unbalance Port Matching Impedance (nominal)	50Ω		
Balance Port Matching Impedance (nominal)	150Ω//15nH		
Input Signal Level	20mW (+13dBm), 2000 hours		

SAW FILTER FOR GSM1800/GSM1900 (Rx)

Murata part number : SAWEP1G84CQ0F00 (fc=1842.5MHz)

Frequency Performance

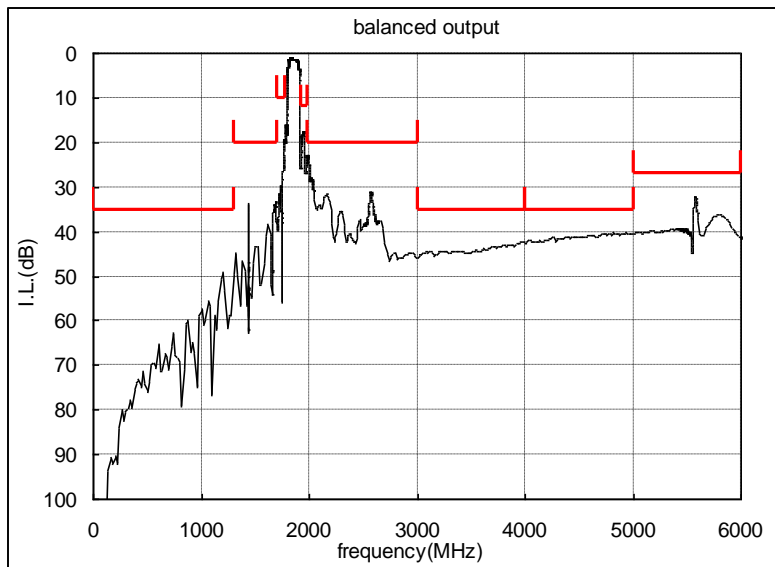
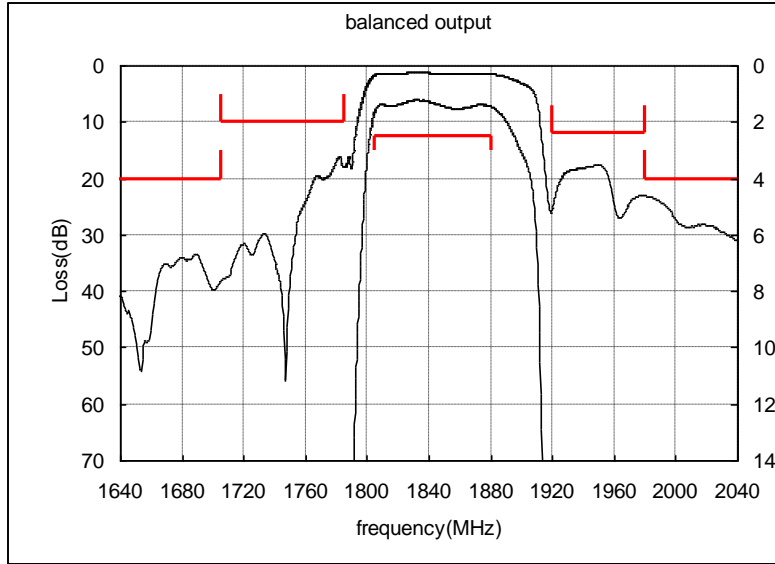

Amplitude balance

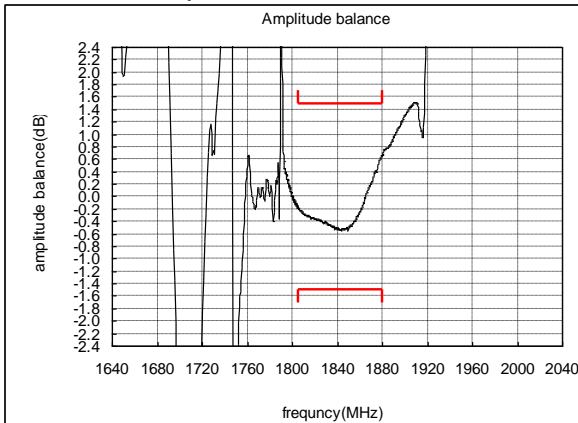

Phase balance

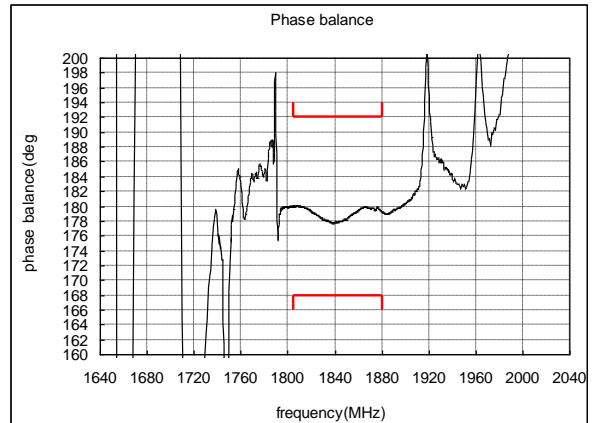

SAW FILTER FOR GSM1800/GSM1900 (Rx)

Murata part number : SAWEP1G84CQ0F00 (fc=1960MHz)

Package Dimensions

Specification

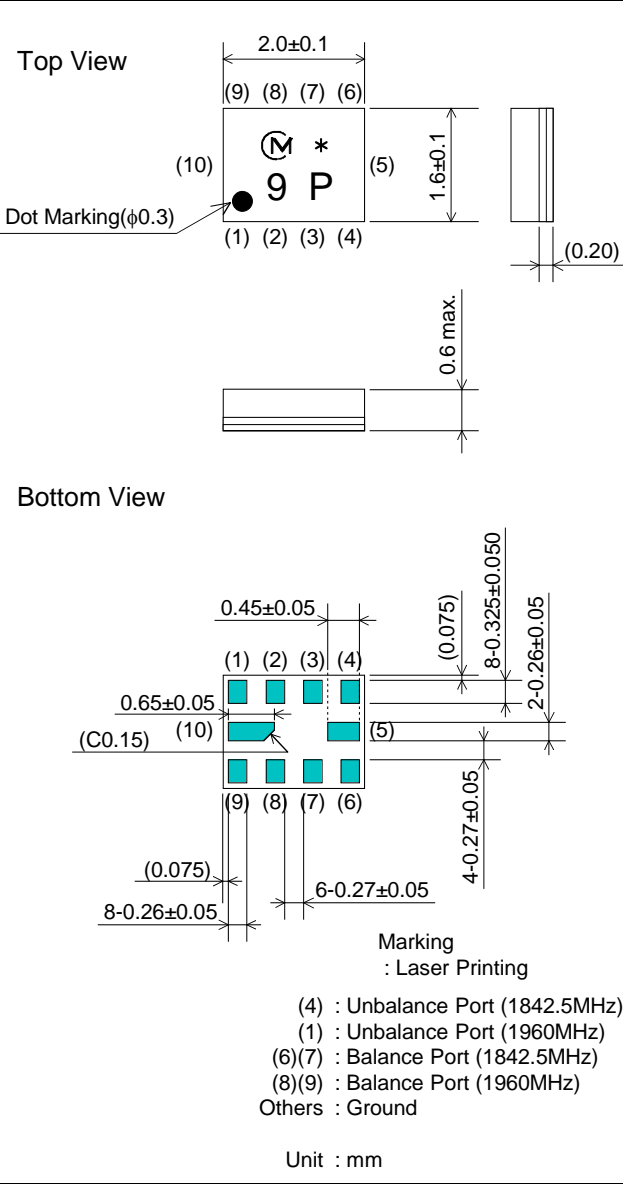

Item	Specification		
	-30 to 85°C	25±2°C	typ.
Nominal Center Frequency(fc)	1960MHz		
Insertion Loss (1930 to 1990MHz)	2.6 dB max.	2.0 dB max.	1.6 dB
Absolute Attenuation			
1) 0.1 to 1830 MHz	23 dB min.	23 dB min.	34 dB
2) 1830 to 1910 MHz	11 dB min.	11 dB min.	14 dB
3) 2010 to 2070 MHz	6 dB min.	12 dB min.	14 dB
4) 2070 to 3000 MHz	20 dB min.	20 dB min.	24 dB
5) 3000 to 5700 MHz	30 dB min.	30 dB min.	35 dB
6) 5700 to 5970 MHz	30 dB min.	30 dB min.	35 dB
7) 5970 to 6000 MHz	30 dB min.	30 dB min.	37 dB
Ripple Deviation (1930 to 1990MHz)	1.8dB max.	1.0dB max.	0.4 dB
VSWR (1930 to 1990MHz)	2.2 max.	1.8 max.	1.6
Amplitude Balance (1930 to 1990MHz)	±2.0dB max.	±1.8dB max.	±1.4dB
Phase Balance (1930 to 1990MHz)	180±12deg. max.	180±9deg. max.	180±5deg.
Unbalance Port Matching Impedance (nominal)	50Ω		
Balance Port Matching Impedance (nominal)	150Ω//18nH		
Input Signal Level	20mW (+13dBm), 2000 hours		

SAW FILTER FOR GSM1800/GSM1900 (Rx)

Murata part number : SAWEP1G84CQ0F00 ($f_c=1960\text{MHz}$)

Frequency Performance

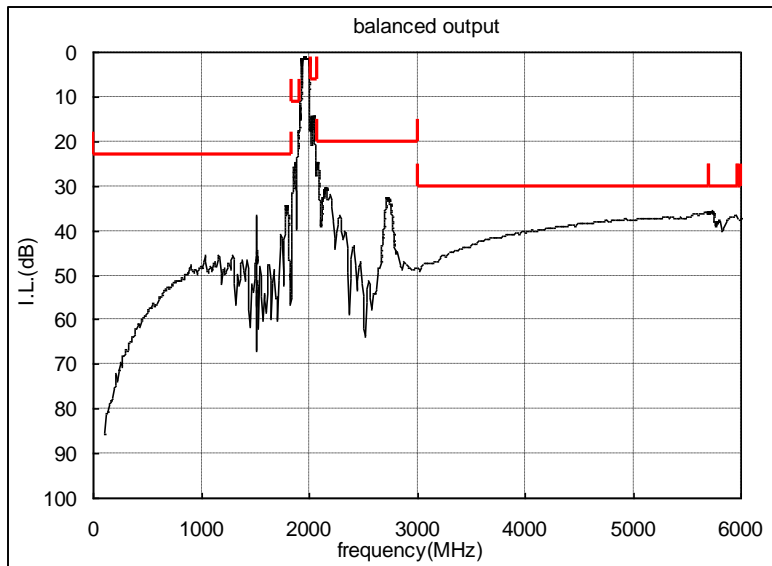
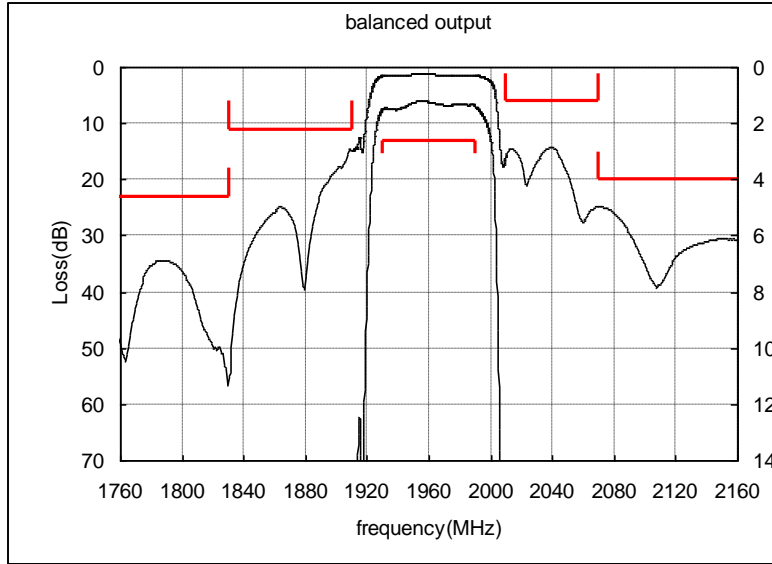

Amplitude balance

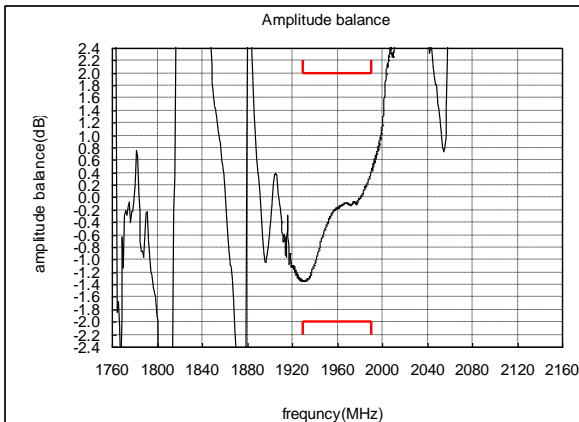

Phase balance

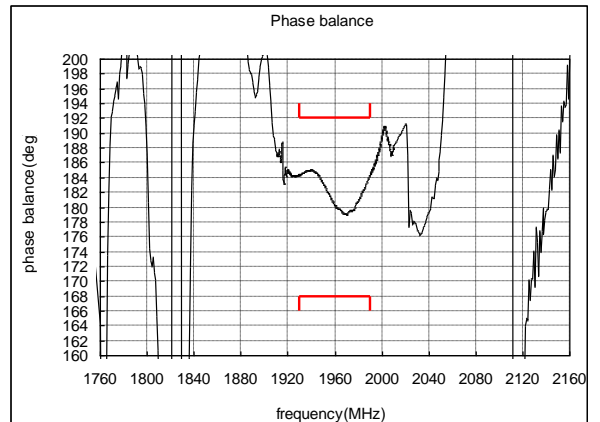

SAW FILTER FOR GSM1800/GSM1900 (Rx)

Murata part number : SAWEP1G84CQ0F00

Dimensions of Carrier Tape

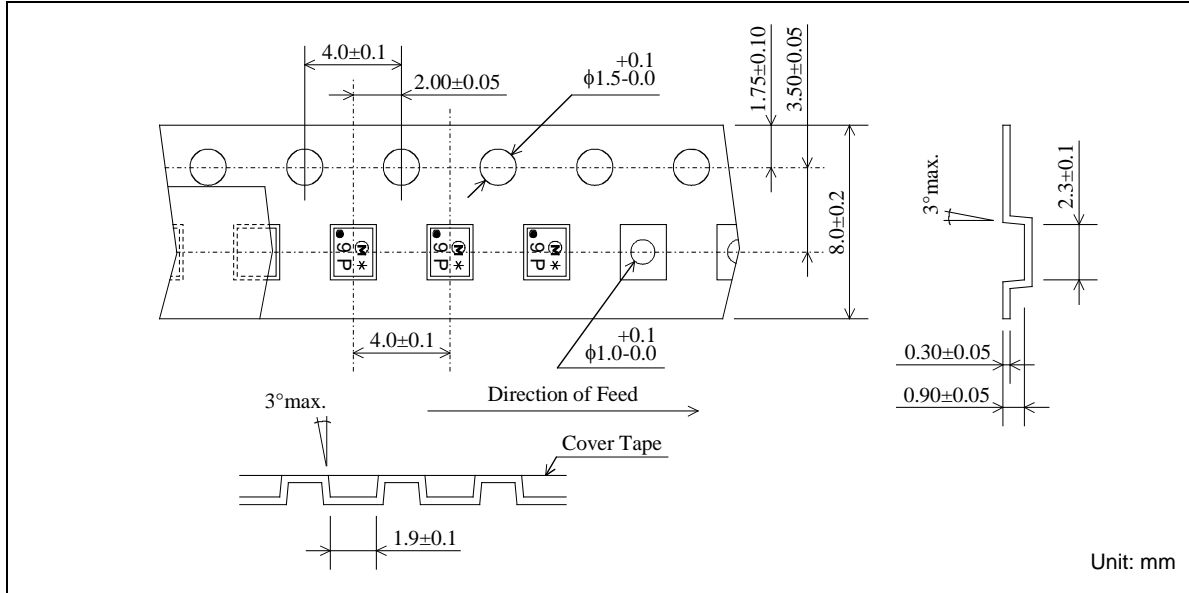

Dimensions of Tape

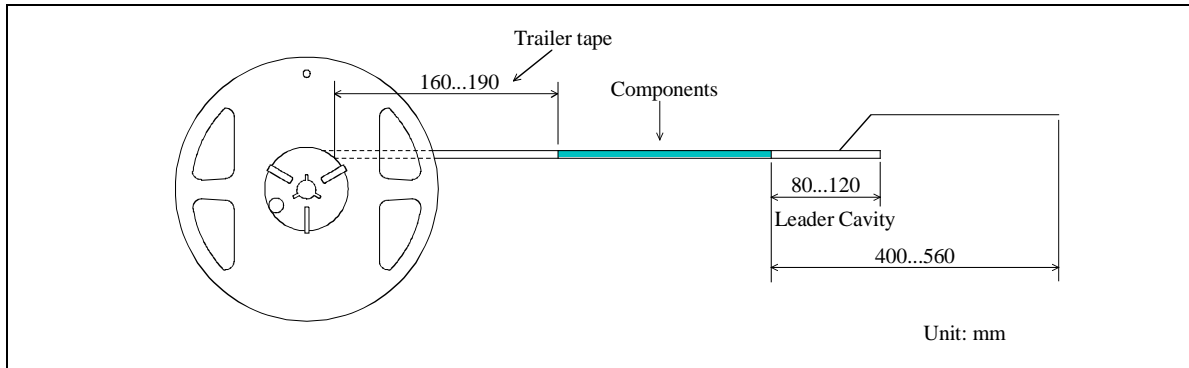

Dimensions of Reel

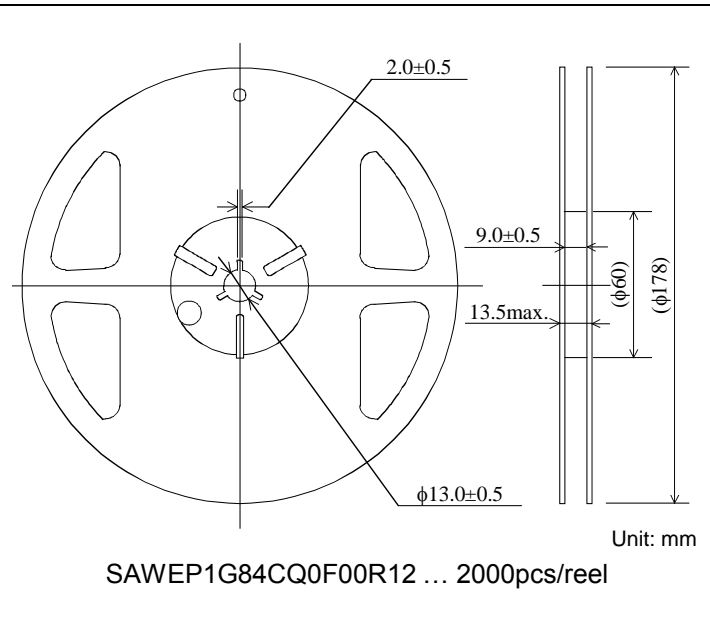
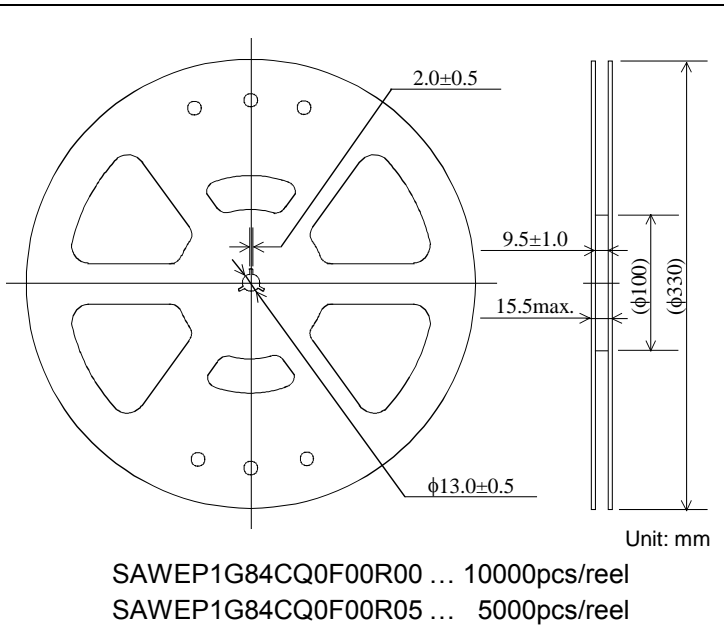

SAW FILTER FOR GSM1800/GSM1900 (Rx)

Murata part number : SAWEP1G84CQ0F00

Recommended Land Pattern

Top View

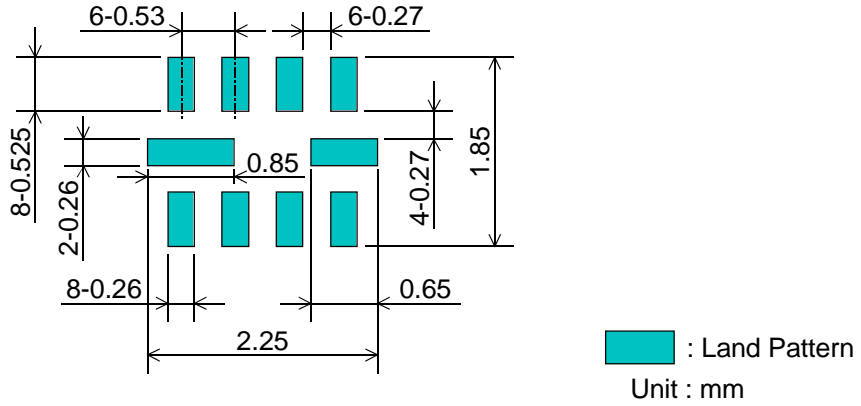

Test Circuit

Bottom View

1842.5MHz

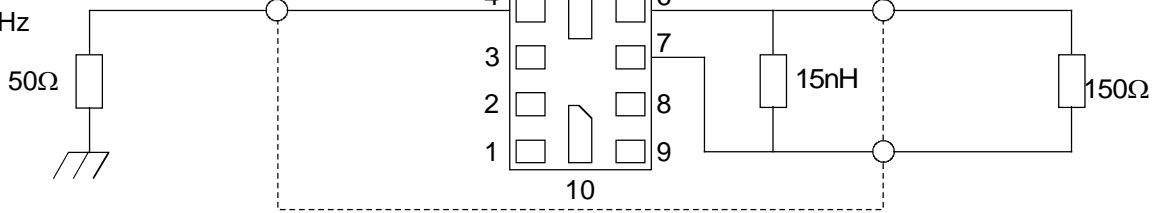

1960MHz

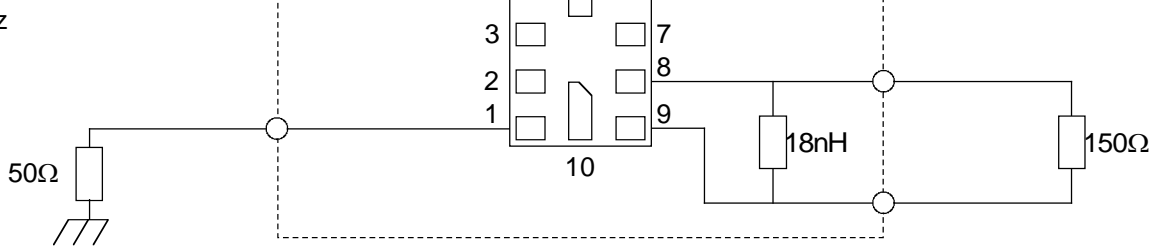

SAW FILTER FOR GSM1800/GSM1900 (Rx)

Murata part number : SAWEP1G84CQ0F00

■ RoHS Compliance

This component is compliant with RoHS directive.

This component was always RoHS compliant from the first date of manufacture.

• Caution - Limitation of Applications

This product is intended for the following applications only; however, please do not use this product in these applications where defects might directly cause damage to a third party's life, body or property.

- a. Mobile Telephone
- b. Cordless phone (except for Automotive use)
- c. PC (Including Notebook PC, Netbook PC, Tablet)
- d. Game
- e. Camera (except for Business/security use)
- f. Set Top Box
- g. Electronic dictionary
- h. Digital audio equipment

• This catalog is for reference only and not an official product specification document, therefore, please review and approve our official product specification before ordering this product.