

Microchip Transformer (Balun) Film Type

DXP18B Series (0603 Size)

■ Dimensions

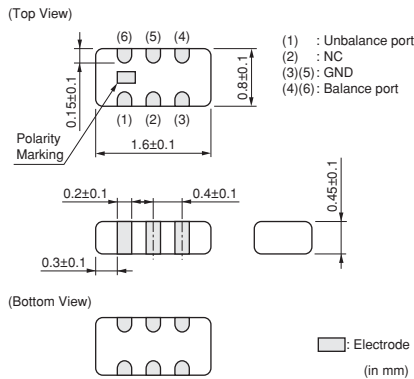

■ Equivalent Circuit

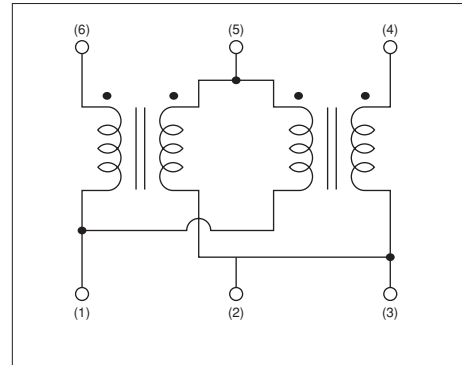

■ Packaging

Code	Packaging	Minimum Quantity
L	180mm Embossed Tape	5000
B	Bulk(Bag)	500

■ Rated Value (□: packaging code)

Part Number	Frequency Range	Port Impedance	Insertion Loss at Freq. Range (max.)	CMRR at Freq. Range (min.)	Rated Power	Operating Temperature Range
DXP18BN5014H□	470 to 790MHz	50 ohm - 200 ohm	1.2dB	25dB	20dBm	-40 to +85°C
DXP18BN5014T□	50 to 870MHz	50 ohm - 200 ohm	1.5dB	25dB	20dBm	-40 to +85°C
DXP18BN5016D□	470 to 870MHz	50 ohm - 300 ohm	1.2dB	25dB	20dBm	-40 to +85°C
DXP18BN7514T□	50 to 870MHz	75 ohm - 300 ohm	1.5dB	25dB	20dBm	-40 to +85°C

Only for reflow soldering.

■ Insertion Loss Characteristics DXP18BN5014H

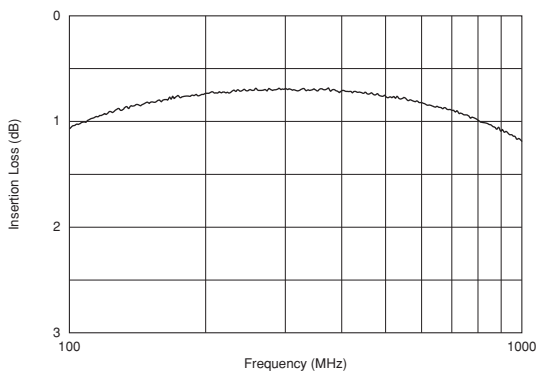

■ CMRR Characteristics DXP18BN5014H

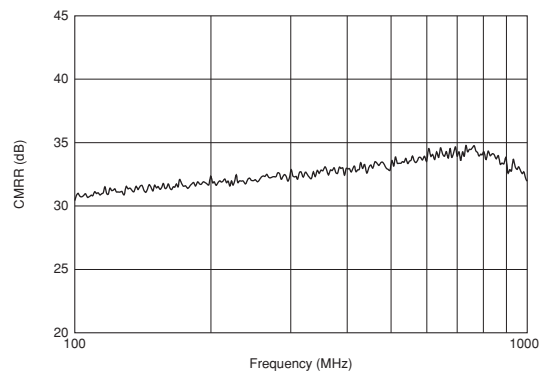

Continued on the following page.

● This data sheet is applied for Micro Chip Transformer used for General Electronics equipment for your design.

⚠ Note:

1. This datasheet is downloaded from the website of Murata Manufacturing co., ltd. Therefore, it's specifications are subject to change or our products in it may be discontinued without advance notice. Please check with our sales representatives or product engineers before ordering.
2. This datasheet has only typical specifications because there is no space for detailed specifications. Therefore, please approve our product specifications or transact the approval sheet for product specifications before ordering.

Continued from the preceding page.

Insertion Loss Characteristics
DXP18BN5014T

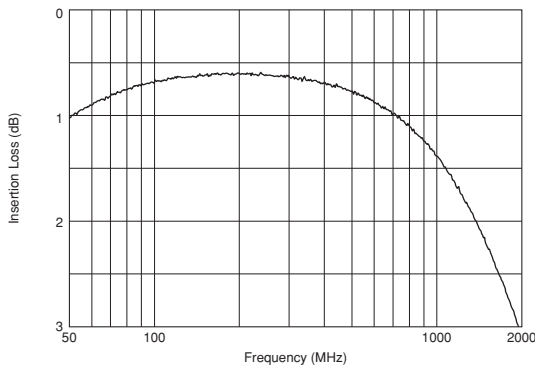

CMRR Characteristics
DXP18BN5014T

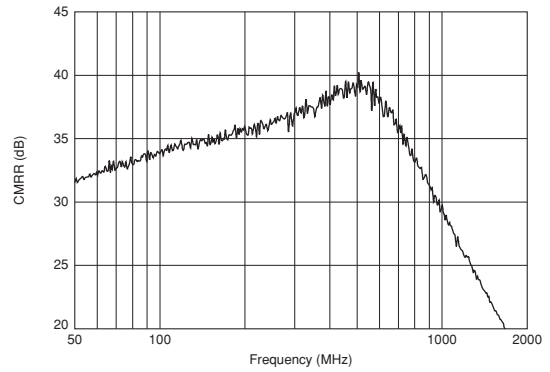

Insertion Loss Characteristics
DXP18BN5016D

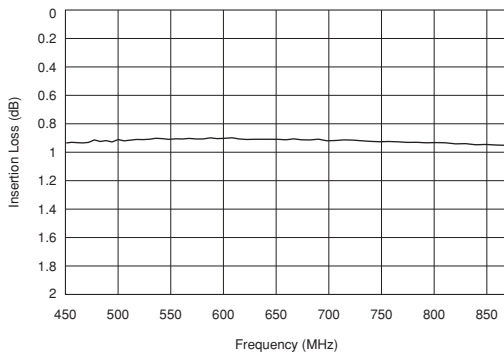

CMRR Characteristics
DXP18BN5016D

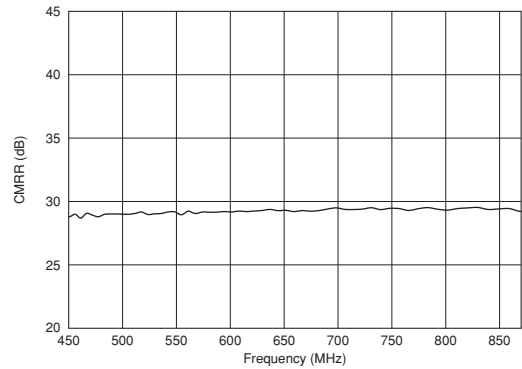

Insertion Loss Characteristics
DXP18BN7514T

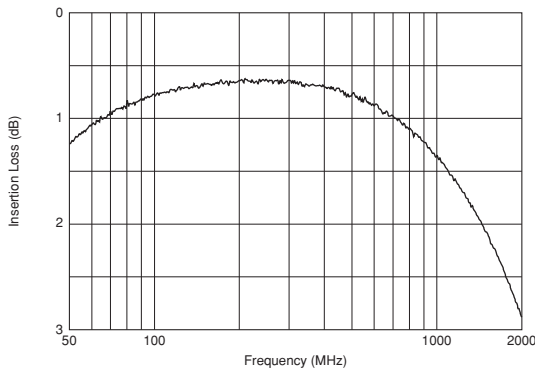

CMRR Characteristics
DXP18BN7514T

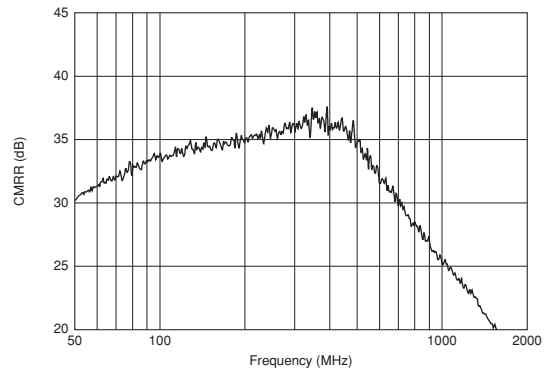

Continued on the following page.

● This data sheet is applied for Micro Chip Transformer used for General Electronics equipment for your design.

Note:

1. This datasheet is downloaded from the website of Murata Manufacturing co., ltd. Therefore, it's specifications are subject to change or our products in it may be discontinued without advance notice. Please check with our sales representatives or product engineers before ordering.
2. This datasheet has only typical specifications because there is no space for detailed specifications. Therefore, please approve our product specifications or transact the approval sheet for product specifications before ordering.

 Continued from the preceding page.

■ Caution/Notice

Caution (Rating)

Do not use products beyond the rated current and rated voltage as this may create excessive heat and deteriorate the insulation resistance.

Notice

Solderability of Tin plating termination chip might be deteriorated when low temperature soldering profile where peak solder temperature is below the Tin melting point is used. Please confirm the solderability of Tin plating termination chip before use.

● This data sheet is applied for Micro Chip Transformer used for General Electronics equipment for your design.

Note:

1. This datasheet is downloaded from the website of Murata Manufacturing co., ltd. Therefore, it's specifications are subject to change or our products in it may be discontinued without advance notice. Please check with our sales representatives or product engineers before ordering.
2. This datasheet has only typical specifications because there is no space for detailed specifications. Therefore, please approve our product specifications or transact the approval sheet for product specifications before ordering.