



Package: SOT-363



Product Description

The SGA2163Z is a high performance SiGe HBT MMIC Amplifier. A Darlington configuration featuring one-micron emitters provides high F_T and excellent thermal performance. The heterojunction increases breakdown voltage and minimizes leakage current between junctions. Cancellation of emitter junction non-linearities results in higher suppression of intermodulation products. Only two DC-blocking capacitors, a bias resistor, and an optional RF choke are required for operation.

Optimum Technology Matching® Applied

- GaAs HBT
- GaAs MESFET
- InGaP HBT
- SiGe BiCMOS
- Si BiCMOS
- SiGe HBT
- GaAs pHEMT
- Si CMOS
- Si BJT
- GaN HEMT
- RF MEMS

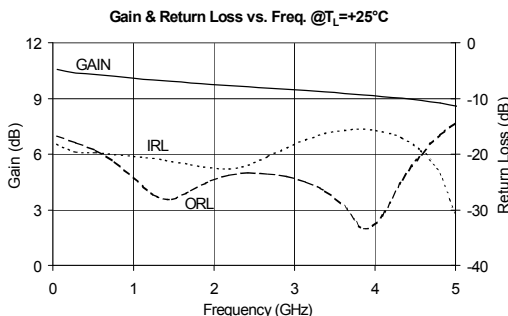

Features

- Broadband Operation: DC to 5000 MHz
- Cascadable 50Ω
- Operates from Single Supply
- Low Thermal Resistance Package

Applications

- PA Driver Amplifier
- Cellular, PCS, GSM, UMTS
- IF Amplifier
- Wireless Data, Satellite

Parameter	Specification			Unit	Condition
	Min.	Typ.	Max.		
Small Signal Gain	9.5	10.5	11.5	dB	850 MHz
		9.8		dB	1950 MHz
		9.6		dB	2400 MHz
Output Power at 1dB Compression		7.1		dBm	850 MHz
		6.2		dBm	1950 MHz
Output Third Intercept Point		21.0		dBm	850 MHz
		18.0		dBm	1950 MHz
Bandwidth Determined by Return Loss		5000		MHz	>10 dB
Input Return Loss		22.5		dB	1950 MHz
Output Return Loss		24.8		dB	1950 MHz
Noise Figure		4.4		dB	1950 MHz
Device Operating Voltage	1.9	2.2	2.5	V	
Device Operating Current	17	20	23	mA	
Thermal Resistance		255		°C/W	junction - lead

Test Conditions: $V_S=5V$, $I_D=20mA$ Typ., OIP_3 Tone Spacing=1MHz, P_{OUT} per tone=-10dBm, $R_{BIAS}=140\Omega$, $T_L=25^\circ C$, $Z_S=Z_L=50\Omega$

Absolute Maximum Ratings

Parameter	Rating	Unit
Max Device Current (I_D)	40	mA
Max Device Voltage (V_D)	4	V
Max RF Input Power	+18	dBm
Max Junction Temperature (T_J)	+150	°C
Operating Temperature Range (T_L)	-55 to +110	°C
Max Storage Temperature	+150	°C

Operation of this device beyond any one of these limits may cause permanent damage. For reliable continuous operation, the device voltage and current must not exceed the maximum operating values specified in the table on page one.

Bias Conditions should also satisfy the following expression:

$$I_D V_D < (T_J - T_L) / R_{TH} \text{ J}$$



Caution! ESD sensitive device.

Exceeding any one or a combination of the Absolute Maximum Rating conditions may cause permanent damage to the device. Extended application of Absolute Maximum Rating conditions to the device may reduce device reliability. Specified typical performance or functional operation of the device under Absolute Maximum Rating conditions is not implied.

The information in this publication is believed to be accurate and reliable. However, no responsibility is assumed by RF Micro Devices, Inc. ("RFMD") for its use, nor for any infringement of patents, or other rights of third parties, resulting from its use. No license is granted by implication or otherwise under any patent or patent rights of RFMD. RFMD reserves the right to change component circuitry, recommended application circuitry and specifications at any time without prior notice.



RFMD Green: RoHS compliant per EU Directive 2002/95/EC, halogen free per IEC 61249-2-21, < 1000ppm each of antimony trioxide in polymeric materials and red phosphorus as a flame retardant, and <2% antimony in solder.

Typical Performance at Key Operating Frequencies

Parameter	Unit	100MHz	500MHz	850MHz	1950MHz	2400MHz	3500MHz
Small Signal Gain	dB	10.7	10.6	10.5	9.8	9.6	9.3
Output Third Order Intercept Point	dBm		20.9	21.0	18.0	16.9	
Output Power at 1dB Compression	dBm		7.2	7.1	6.2	5.6	
Input Return Loss	dB	18.7	19.8	20.3	22.5	22.1	16.0
Output Return Loss	dB	17.2	19.1	22.3	24.8	23.4	27.6
Reverse Isolation	dB	15.6	15.4	15.5	16.1	16.4	16.9
Noise Figure	dB		4.2	4.1	4.4	4.8	

Test Conditions: $V_S = 5V$, $I_D = 20mA$ Typ., OIP₃ Tone Spacing = 1MHz, P_{OUT} per tone = -10dBm, R_{BIAS} = 140Ω, T_L = 25°C, Z_S = Z_L = 50Ω

OIP₃ vs. Frequency
V_D = 2.2 V, I_D = 20 mA

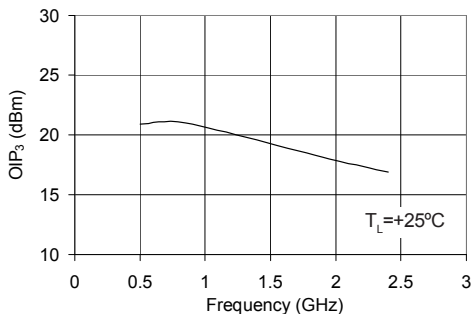

P_{1dB} vs. Frequency
V_D = 2.2 V, I_D = 20 mA

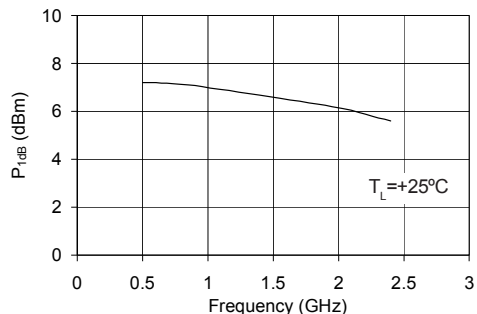

Noise Figure vs. Frequency
V_D = 2.2 V, I_D = 20 mA

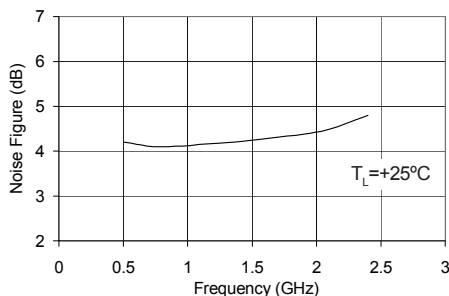

Extended Temperature versus Frequency
300kHz to 5GHz

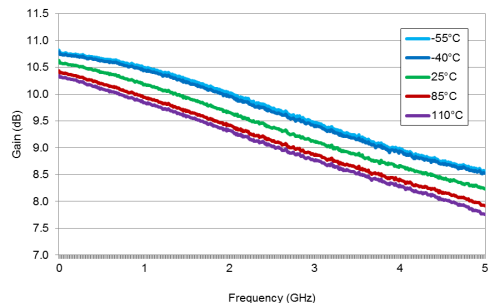

Typical RF Performance Over Temperature (Bias: $V_D=2.2V$, $I_D=20mA$ (Typ.))

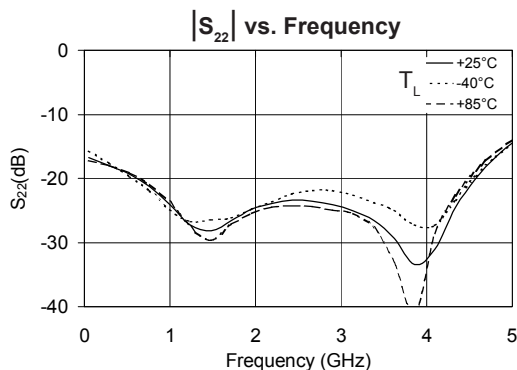
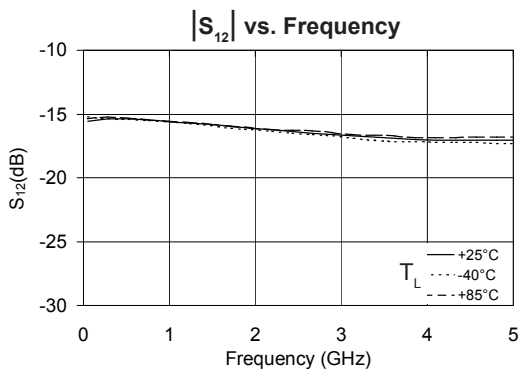
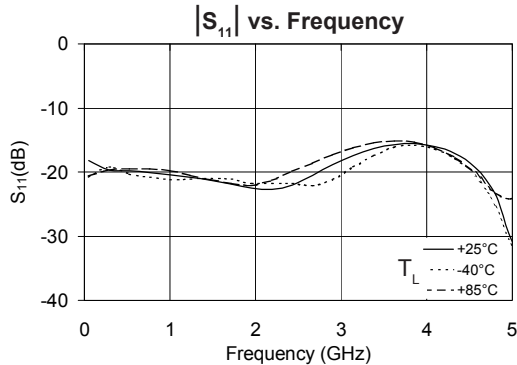
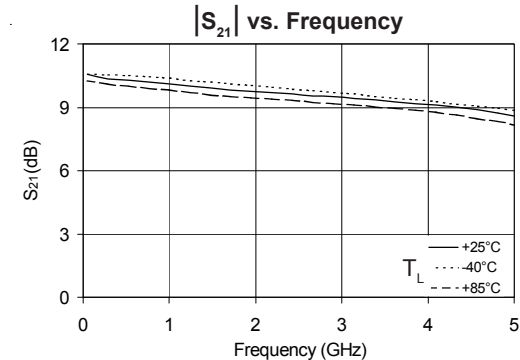

Pin	Function	Description
3	RF IN	RF input pin. This pin requires the use of an external DC blocking capacitor chosen for the frequency of operation.
1, 2, 4, 5	GND	Connection to ground. Use via holes for best performance to reduce lead inductance as close to ground leads as possible.
6	RF OUT/BIAS	RF output and bias pin. DC voltage is present on this pin, therefore a DC blocking capacitor is necessary for proper operation.

Basic Application Circuit

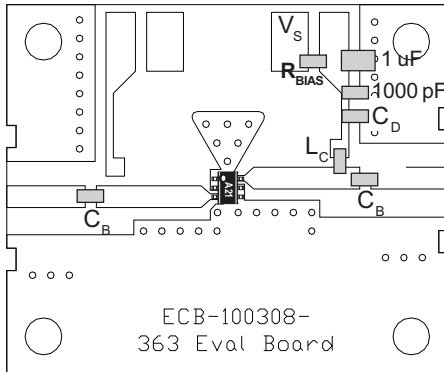
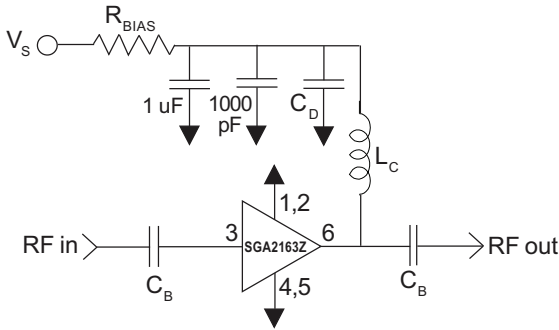

Application Circuit Element Values

Reference Designator	Frequency (Mhz)				
	500	850	1950	2400	3500
C _b	220 pF	100 pF	68 pF	56 pF	39 pF
C _d	100 pF	68 pF	22 pF	22 pF	15 pF
L _c	68 nH	33 nH	22 nH	18 nH	15 nH

Recommended Bias Resistor Values for I_b=20mA

$$R_{BIAS} = (V_S - V_D) / I_b$$

Supply Voltage (V _S)	5 V	6 V	8 V	10 V
R _{BIAS}	140 Ω	200 Ω	300 Ω	390 Ω

Note: R_{BIAS} provides DC bias stability over temperature.

Mounting Instructions

1. Use a large ground pad area near device pins 1, 2, 4, and 5 with many plated through-holes as shown.
2. We recommend 1 or 2 ounce copper. Measurements for this data sheet were made on a 31 mil thick FR-4 board with 1 ounce copper on both sides.

SOT-363 PCB Pad Layout

SOT-363 PCB Pad Layout

Dimensions in inches [millimeters]

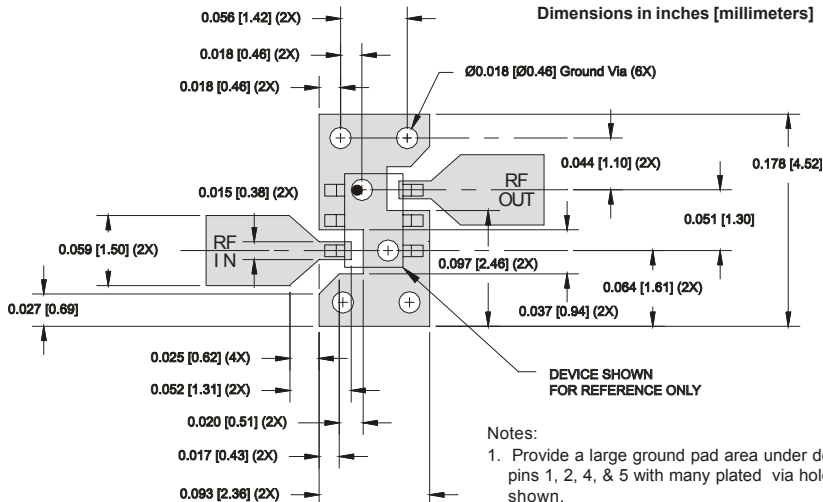

Notes:

1. Provide a large ground pad area under device pins 1, 2, 4, & 5 with many plated via holes as shown.
2. Dimensions given for 50 Ohm RF I/O lines are for 31 mil thick Getek. Scale accordingly for different board thicknesses and dielectric constants.
3. We recommend 1 or 2 ounce copper. Measurements for this data sheet were made on a 31 mil thick Getek with 1 ounce copper on both sides.

Package Dimensions

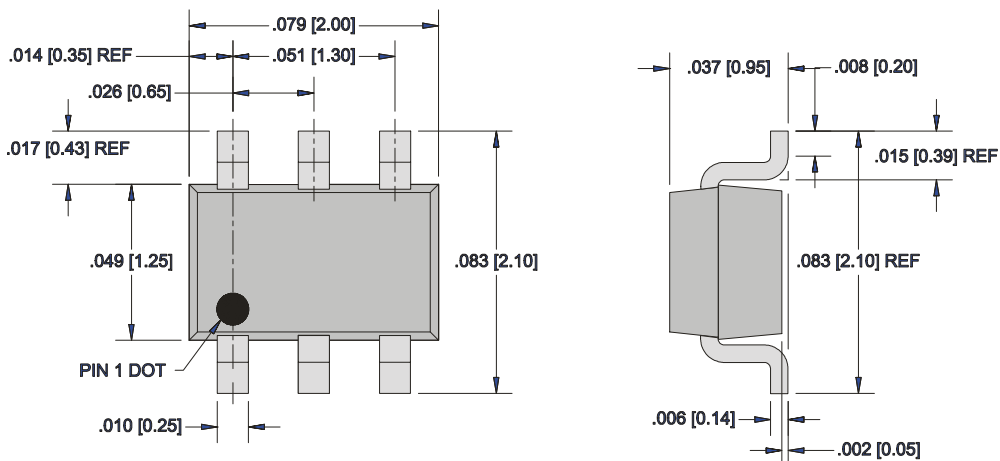

Package Drawing.

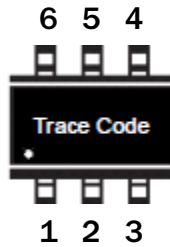

Ordering Information

Ordering Code	Description
SGA2163Z	7" Reel with 3000 pieces
SGA2163ZSQ	Sample bag with 25 pieces
SGA2163ZSR	7" Reel with 100 pieces
SGA2163ZPCK1	850MHz, 5V Operation PCBA with 5-piece sample bag