



Product Description

RFMD’s SGA8543Z is a high performance Silicon Germanium Heterostructure Bipolar Transistor (SiGe HBT) designed for operation from 50MHz to 3.5GHz. The SGA8543Z is optimized for 3.3V operation but can be biased at 2.7V for low-voltage battery operated systems. The device provides low NF and excellent linearity at a low cost. It can be operated over a wide range of currents depending on the power and linearity requirements. The matte tin finish on the lead-free “Z” package is applied using a post annealing process to mitigate tin whisker formation and is RoHS compliant per EU Directive 2002/95. The package body is manufactured with green molding compounds that contain no antimony trioxide or halogenated fire retardants.

Optimum Technology Matching® Applied

- GaAs HBT
- GaAs MESFET
- InGaP HBT
- SiGe BiCMOS
- Si BiCMOS
- SiGe HBT
- GaAs pHEMT
- Si CMOS
- Si BJT
- GaN HEMT
- RF MEMS

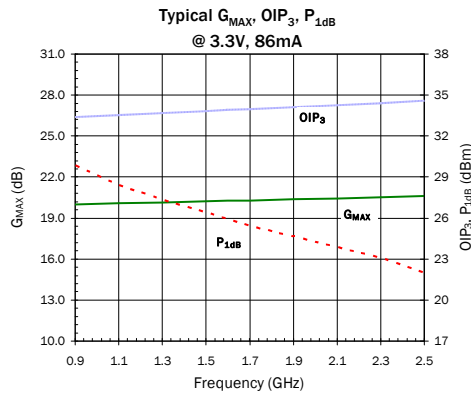

Features

- .05GHz to 3.5GHz Operation
- Lead Free, RoHS Compliant, and Green Package
- 1.5dB NF_{MIN} at 2.44GHz
- 15.6dB G_{MAX} at 2.44GHz
- P_{1dB} = +20.6dBm at 2.44GHz
- OIP₃ = +34.6dBm at 2.44GHz
- Low Cost, High Performance, Versatility

Applications

- Analog and Digital Wireless Systems
- 3G, Cellular, PCS, RFID
- Fixed Wireless, Pager Systems
- PA Stage for Medium Power Applications
- AN-079 Contains Detailed Application Circuits

Parameter	Specification			Unit	Condition
	Min.	Typ.	Max.		
Power Gain		19.0		dB	880MHz, Z _S =Z _{SOPT} , Z _L =Z _{LOPT}
		14.0		dB	2440MHz
Output Power at 1dB Compression [2]		20.0		dBm	880MHz, Z _S =Z _{SOPT} , Z _L =Z _{LOPT}
		20.6		dBm	2440MHz
Output Third Order Intercept Point [2]		33.4		dBm	880MHz, Z _S =Z _{SOPT} , Z _L =Z _{LOPT}
		34.6		dBm	2440MHz
Noise Figure		3.1		dB	880MHz, Z _S =Z _{SOPT} , Z _L =Z _{LOPT}
		2.4		dB	2440MHz
Minimum Noise Figure		1.0		dB	880MHz, I _{CE} =25mA, Z _S =Γ _{OPT} , Z _L =Z _L , NF _{MIN}
		1.5		dB	2440MHz
Maximum Available Gain		22.9		dB	880MHz, Z _S =Z _S , Z _L =Z _L
		15.0		dB	2440MHz
Insertion Gain [1]		18.0		dB	880MHz
D _{CC} Current Gain	120	180	300		
Breakdown Voltage	5.7	6.0		V	Collector - Emitter
Device Operating Voltage			3.8	V	Collector - Emitter
Device Operating Current			95	mA	Collector - Emitter
Thermal Resistance		151		°C/W	junction to backside

Test Conditions: V_{CE}=3.3V, I_{CE}=86mA Typ. (unless noted otherwise), T₁=25°C, OIP₃ Tone Spacing=1MHz, P_{OUT} per tone=5dBm
 [1] 100% production tested using 50Ω contact board (no matching circuitry) [2] Data with Application Circuit

Absolute Maximum Ratings

Parameter	Rating	Unit
Max Device Current (I_{CE})	105	mA
Max Device Voltage (V_{CE})	4.5	V
Max RF Input Power *(See Note)	18	dBm
Max Junction Temperature (T_J)	150	°C
Operating Temperature Range (T_L)	See Graph	
Max Storage Temperature	150	°C
ESD Rating - Human Body Model (HBM)	Class 1B	
Moisture Sensitivity Level	MSL 1	



Caution! ESD sensitive device.

Exceeding any one or a combination of the Absolute Maximum Rating conditions may cause permanent damage to the device. Extended application of Absolute Maximum Rating conditions to the device may reduce device reliability. Specified typical performance or functional operation of the device under Absolute Maximum Rating conditions is not implied.

RoHS status based on EU Directive 2002/95/EC (at time of this document revision).

The information in this publication is believed to be accurate and reliable. However, no responsibility is assumed by RF Micro Devices, Inc. ("RFMD") for its use, nor for any infringement of patents, or other rights of third parties, resulting from its use. No license is granted by implication or otherwise under any patent or patent rights of RFMD. RFMD reserves the right to change component circuitry, recommended application circuitry and specifications at any time without prior notice.

*Note: Load condition1, $Z_L = 50\Omega$. Load condition2, $Z_L = 10:1$ VSWR.

Operation of this device beyond any one of these limits may cause permanent damage. For reliable continuous operation, the device voltage and current must not exceed the maximum operating values specified in the table on page one.

Bias Conditions should also satisfy the following expression:

$$I_D V_D < (T_J - T_L) / R_{TH, j-l} \text{ and } T_L = T_{LEAD}$$

Typical Performance with 2.45GHz Application Circuit

Freq (MHz)	VCE (v)	ICE (mA)	P1dB (dBm)	OIP3 (dBm)	Gain (dB)	S11 (dB)	S22 (dB)	NF (dB)	ZSOPT (W)	ZLOPT (W)
880	3.3	86.0	20.0	33.4	19.0	-15.0	-11.0	3.1	22.9-j2.95	29.4+j0.9
2440	3.3	86.0	20.6	34.6	14.0	-16.0	-22.0	2.4	9.3-j9.9	33.6-j4.7

Test Conditions: $V_S = 5V$, $I_S = 96mA$ Typ., OIP₃ Tone Spacing=1MHz, P_{OUT} per tone=-5dBm, $T_L = 25^\circ C$

Power Derating Curve

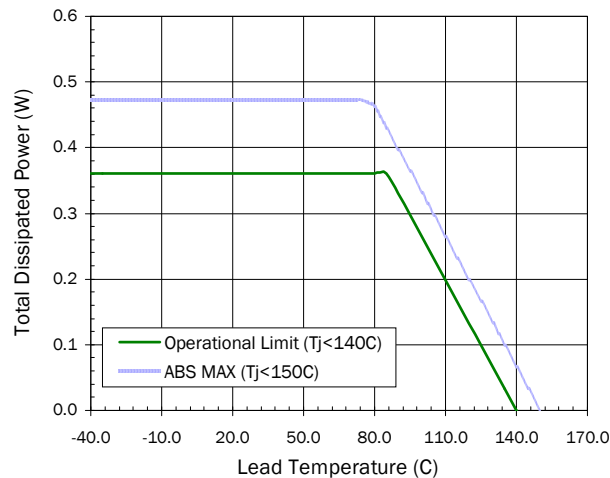

Insertion Gain and Isolation
($I_{CE} = 86\text{mA}$)

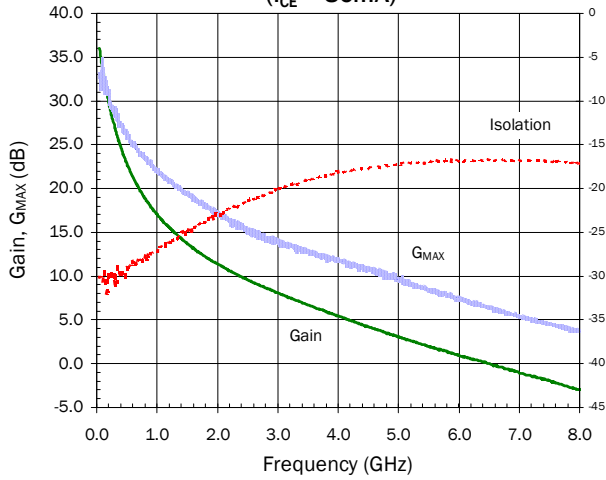

DCIV Curves
(2440 MHz Ckt.)

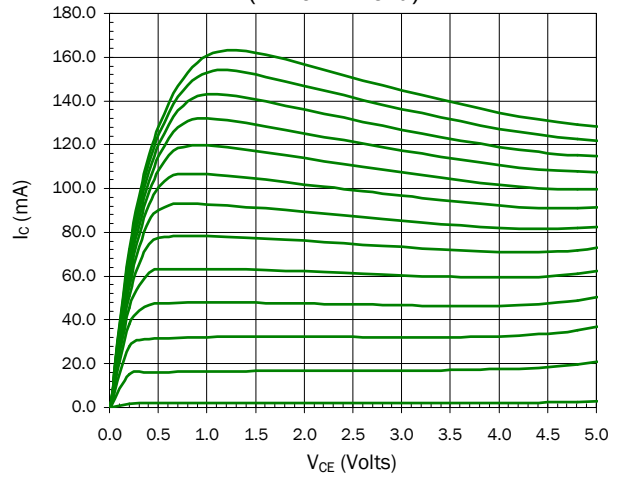

S11 versus Frequency

S11 Vs. Frequency

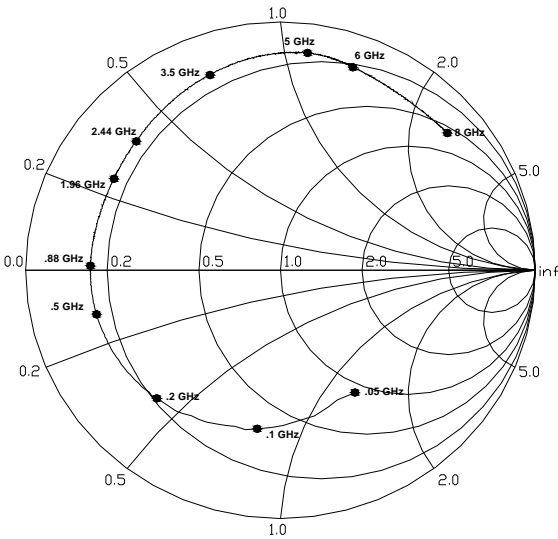

S22 versus Frequency

S22 Vs. Frequency

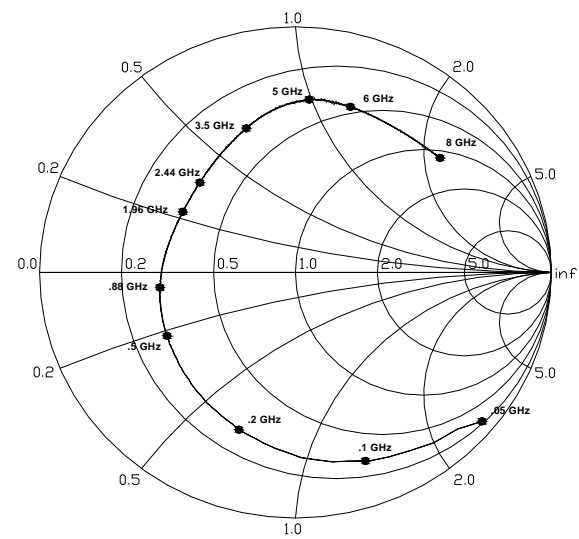

Note:

S-parameters are de-embedded to the device leads with $Z_S=Z_L=50\Omega$. De-embedded S-parameters can be downloaded from our website (www.rfmd.com)

Part Identification Marking

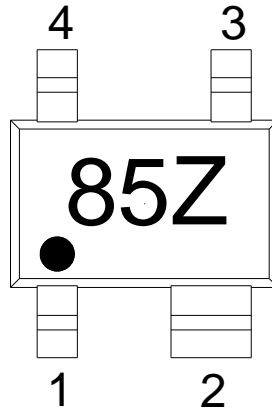

Alternate Marking with Trace Code Only

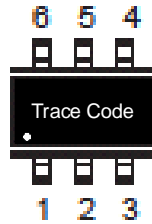

Suggested Pad Layout

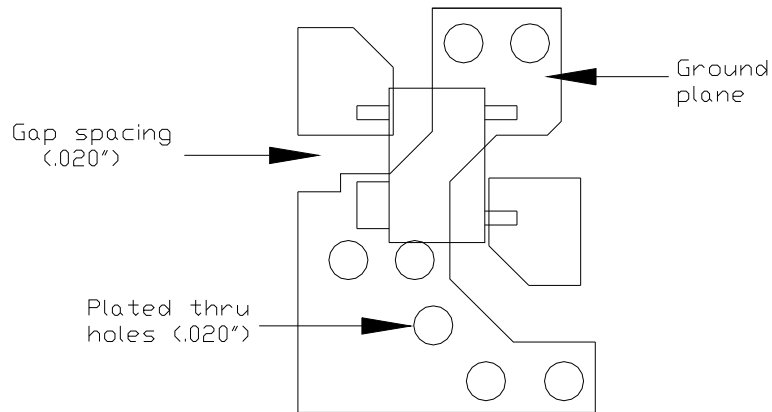

Board Thickness 0.031"
Copper Cladding 1oz. both sides

Pin	Function	Description
1	RF IN	RF input / Base Bias. External DC blocking capacitor required.
2	GND	Connection to ground. Use via holes to reduce lead inductance. Place via holes as close to lead as possible.
3	RF OUT	RF Out / Collector bias. External DC blocking capacitor required.
4	GND	Connection to ground. Use via holes to reduce lead inductance. Place via holes as close to lead as possible.

Package Dimensions

Dimensions in inches (millimeters)
Refer to drawing posted at www.rfmd.com for tolerances.

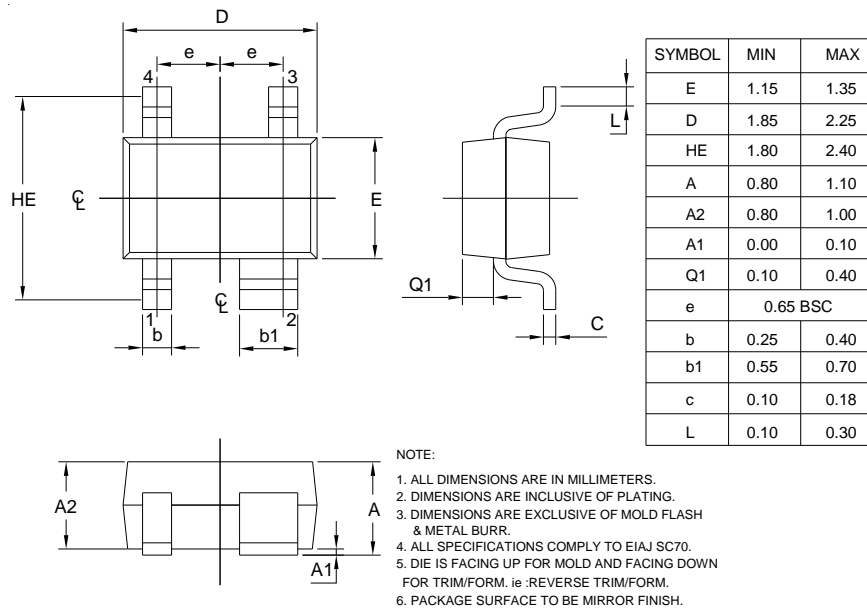

Ordering Information

Ordering Code	Description
SGA8543ZSQ	Sample Bag with 25 pieces
SGA8543ZSR	7" Reel with 100 pieces
SGA8543Z	7" Reel with 3000 pieces
SGA8543Z-EVB1	880MHz PCBA with 5-piece sample bag
SGA8543Z-EVB2	2440MHz PCB with 5-piece sample bag