

Heterojunction Bipolar Transistor (InGaP HBT)

Broadband High Linearity Amplifier

The MMG3008NT1 is a general purpose amplifier that is internally input and output matched. It is designed for a broad range of Class A, small-signal, high linearity, general purpose applications. It is suitable for applications with frequencies from 0 to 6000 MHz such as cellular, PCS, BWA, WLL, PHS, CATV, VHF, UHF, UMTS and general small-signal RF.

Features

- Frequency: 0 to 6000 MHz
- P1dB: 15 dBm @ 900 MHz
- Small-Signal Gain: 18.5 dB @ 900 MHz
- Third Order Output Intercept Point: 26 dBm @ 900 MHz
- Single 5 V Supply
- Internally Matched to 50 Ohms
- Cost-effective SOT-89 Surface Mount Plastic Package
- In Tape and Reel. T1 Suffix = 1,000 Units, 12 mm Tape Width, 7-inch Reel.

MMG3008NT1

**0-6000 MHz, 18.5 dB
15 dBm
InGaP HBT GPA**

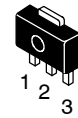

SOT-89

Table 1. Typical Performance (1)

Characteristic	Symbol	900 MHz	2140 MHz	3500 MHz	Unit
Small-Signal Gain (S21)	G _p	18.5	16	13	dB
Input Return Loss (S11)	IRL	-18	-22	-20	dB
Output Return Loss (S22)	ORL	-20	-18	-16	dB
Power Output @1dB Compression	P1dB	15	14	14	dBm
Third Order Output Intercept Point	OIP3	26	25.5	25	dBm

1. V_{CC} = 5 Vdc, T_A = 25°C, 50 ohm system.

Table 2. Maximum Ratings

Rating	Symbol	Value	Unit
Supply Voltage	V _{CC}	6	V
Supply Current	I _{CC}	80	mA
RF Input Power	P _{in}	10	dBm
Storage Temperature Range	T _{stg}	-65 to +150	°C
Junction Temperature	T _J	150	°C

Table 3. Thermal Characteristics

Characteristic	Symbol	Value (2)	Unit
Thermal Resistance, Junction to Case Case Temperature 86°C, 5 Vdc, 38 mA, no RF applied	R _{θJC}	84	°C/W

2. Refer to AN1955, *Thermal Measurement Methodology of RF Power Amplifiers*. Go to <http://www.freescale.com/rf>.
Select Documentation/Application Notes - AN1955.

Table 4. Electrical Characteristics ($V_{CC} = 5$ Vdc, 900 MHz, $T_A = 25^\circ\text{C}$, 50 ohm system, in Freescale Application Circuit)

Characteristic	Symbol	Min	Typ	Max	Unit
Small-Signal Gain (S21)	G_p	17	18.5	—	dB
Input Return Loss (S11)	IRL	—	-18	—	dB
Output Return Loss (S22)	ORL	—	-20	—	dB
Power Output @ 1dB Compression	P1dB	—	15	—	dBm
Third Order Output Intercept Point	OIP3	—	26	—	dBm
Noise Figure	NF	—	4	—	dB
Supply Current (1)	I_{CC}	32	38	48	mA
Supply Voltage (1)	V_{CC}	—	5	—	V

1. For reliable operation, the junction temperature should not exceed 150°C .

Table 5. Functional Pin Description

Pin Number	Pin Function
1	RF_{in}
2	Ground
3	$\text{RF}_{out}/\text{DC Supply}$

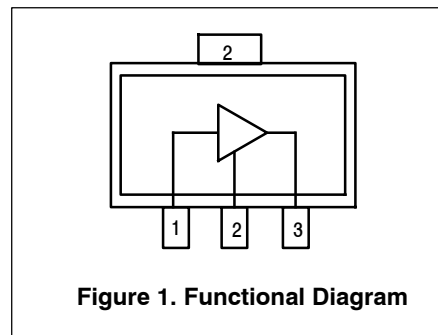
**Figure 1. Functional Diagram****Table 6. ESD Protection Characteristics**

Test Methodology	Class
Human Body Model (per JESD 22-A114)	1A
Machine Model (per EIA/JESD 22-A115)	A
Charge Device Model (per JESD 22-C101)	IV

Table 7. Moisture Sensitivity Level

Test Methodology	Rating	Package Peak Temperature	Unit
Per JESD 22-A113, IPC/JEDEC J-STD-020	1	260	$^\circ\text{C}$

50 OHM TYPICAL CHARACTERISTICS

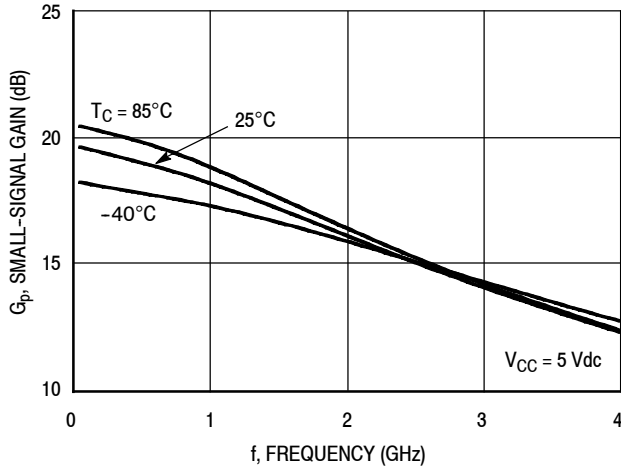

Figure 2. Small-Signal Gain (S21) versus Frequency

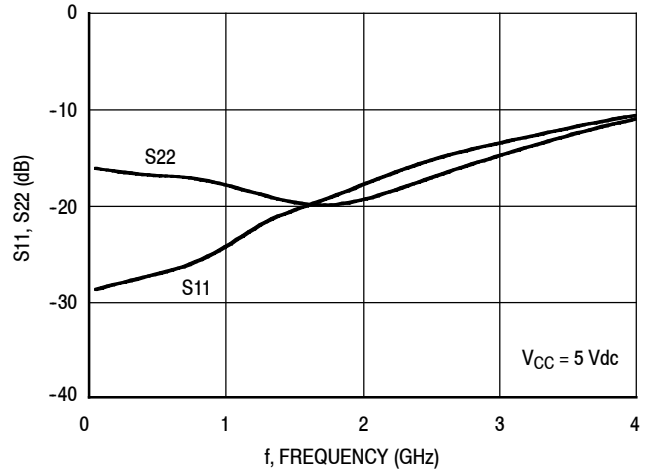

Figure 3. Input/Output Return Loss versus Frequency

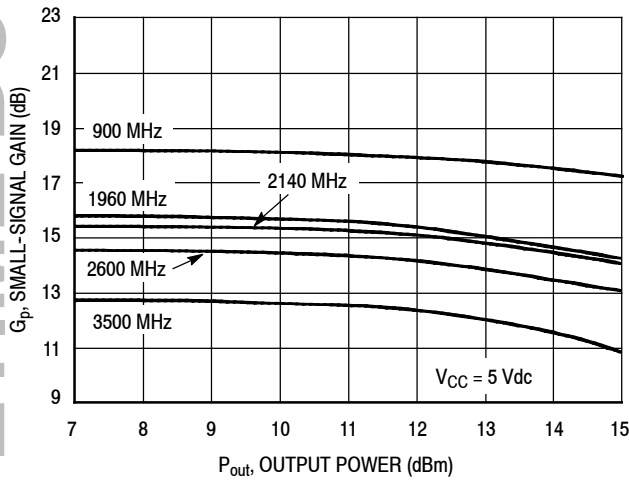

Figure 4. Small-Signal Gain versus Output Power

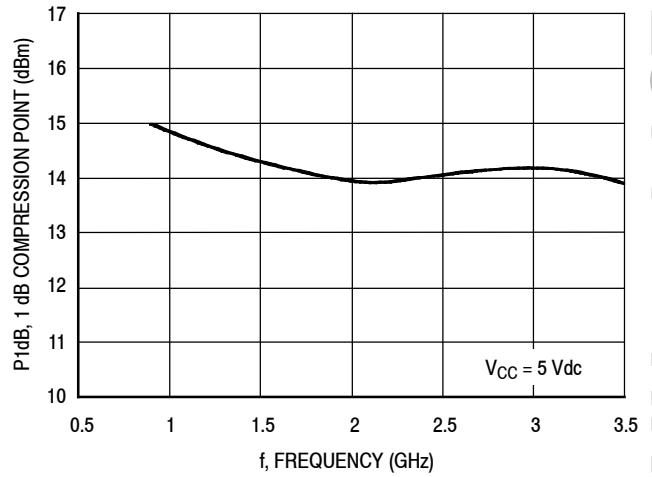

Figure 5. P1dB versus Frequency

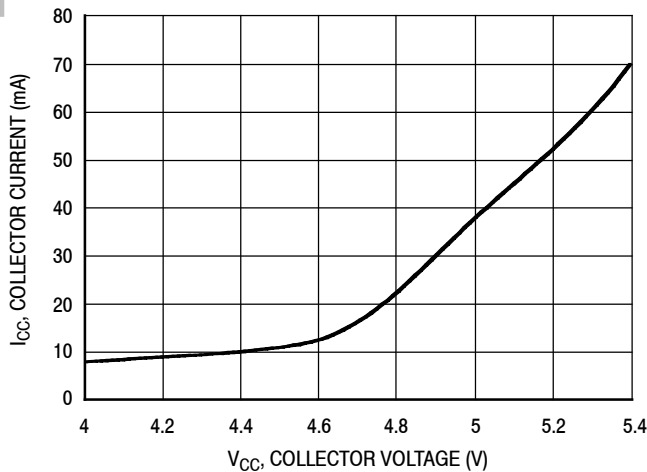

Figure 6. Collector Current versus Collector Voltage

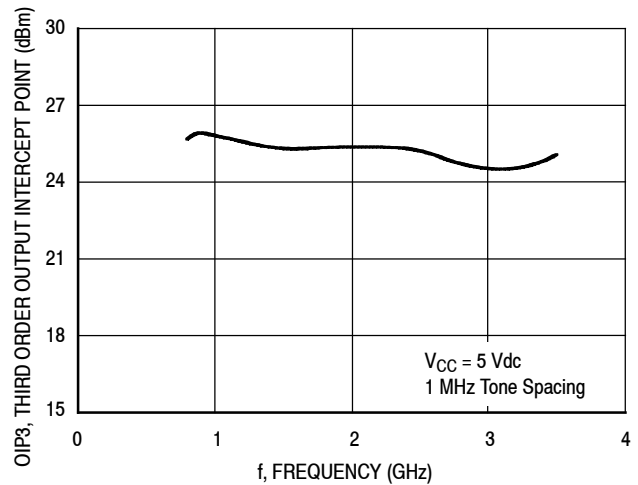

Figure 7. Third Order Output Intercept Point versus Frequency

LIFETIME BUY

LAST ORDER 24 MAY 14 LAST SHIP 24 MAY 15

50 OHM TYPICAL CHARACTERISTICS

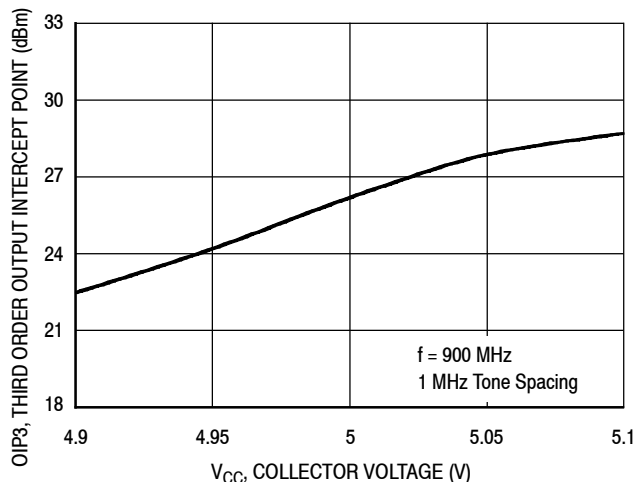

Figure 8. Third Order Output Intercept Point versus Collector Voltage

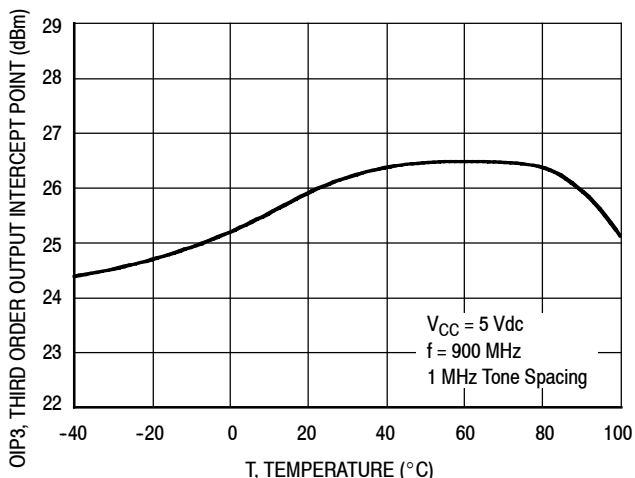

Figure 9. Third Order Output Intercept Point versus Case Temperature

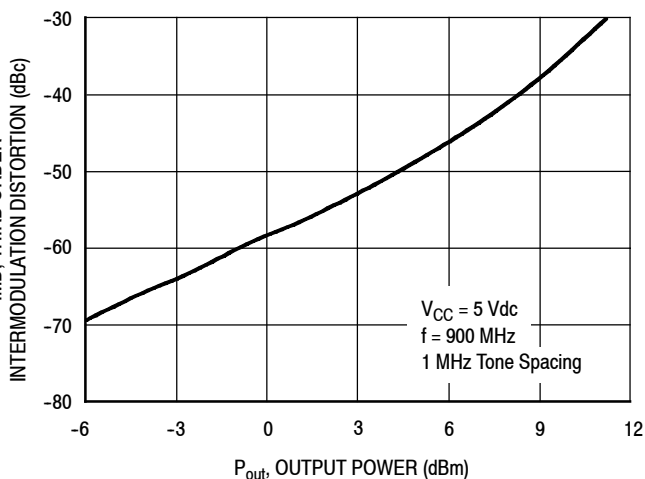
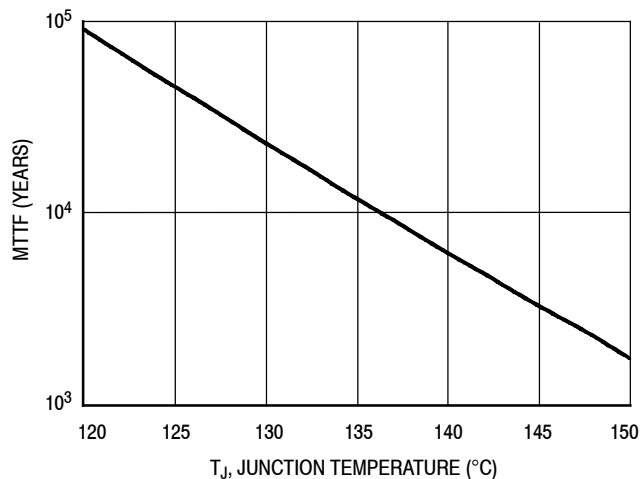

Figure 10. Third Order Intermodulation Distortion versus Output Power



NOTE: The MTTF is calculated with $V_{CC} = 5 \text{ Vdc}$, $I_{CC} = 38 \text{ mA}$

Figure 11. MTTF versus Junction Temperature

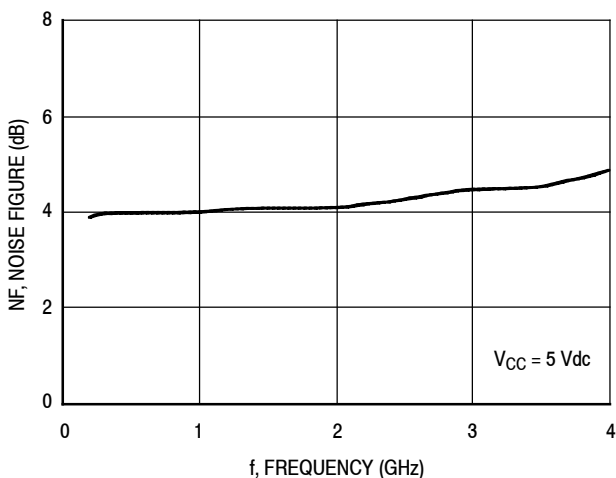

Figure 12. Noise Figure versus Frequency

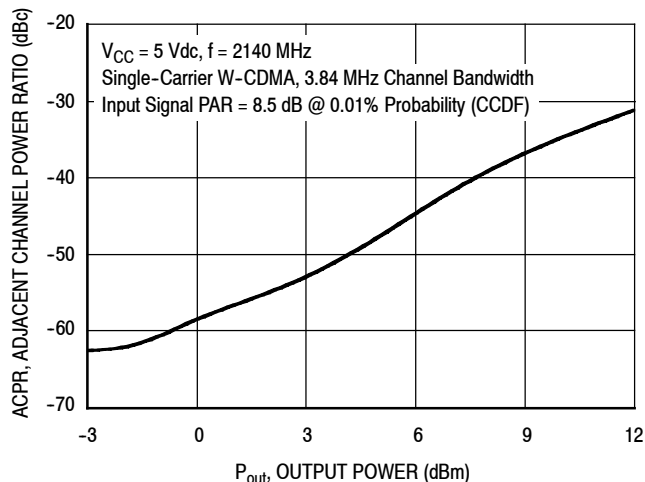

Figure 13. Single-Carrier W-CDMA Adjacent Channel Power Ratio versus Output Power

LIFETIME BUY

LAST ORDER 24 MAY 14 LAST SHIP 24 MAY 15

50 OHM APPLICATION CIRCUIT: 40-300 MHz

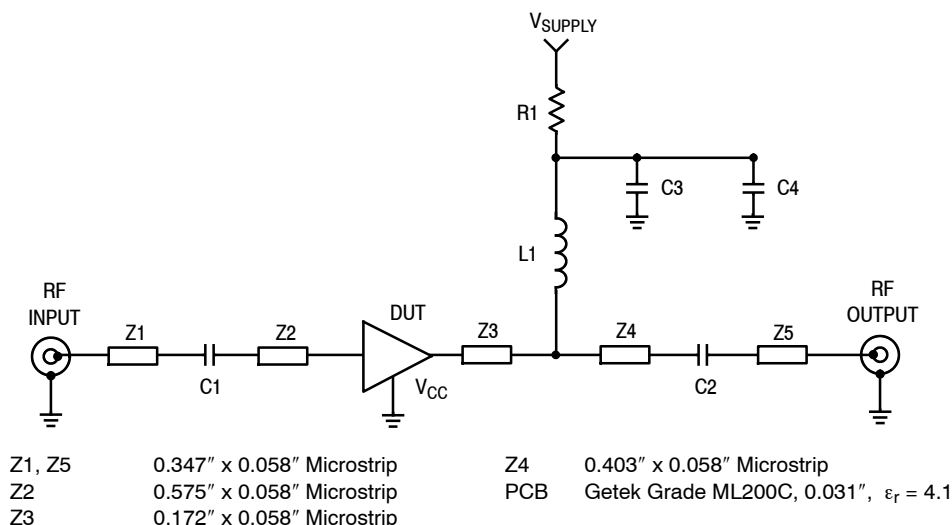

Figure 14. 50 Ohm Test Circuit Schematic

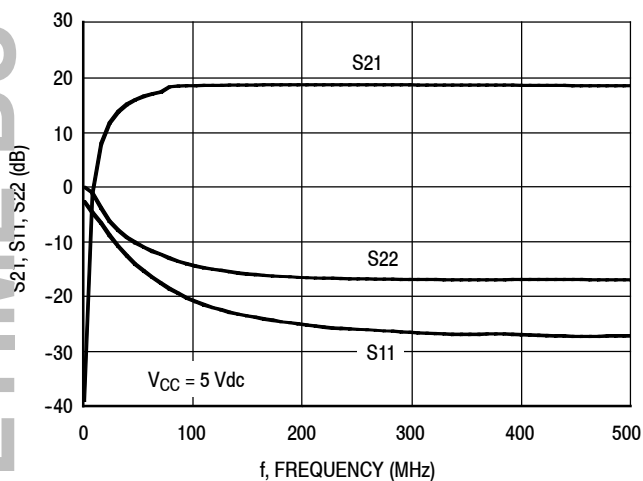

Figure 15. S21, S11 and S22 versus Frequency

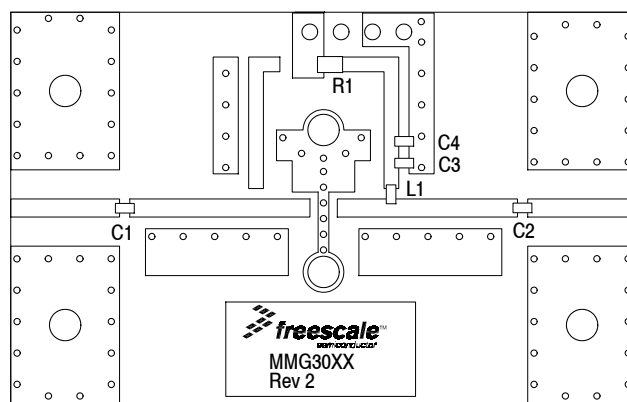

Figure 16. 50 Ohm Test Circuit Component Layout

Table 8. 50 Ohm Test Circuit Component Designations and Values

Part	Description	Part Number	Manufacturer
C1, C2, C3	0.01 μ F Chip Capacitors	C0603C103J5RAC	Kemet
C4	1000 pF Chip Capacitor	C0603C102J5RAC	Kemet
L1	470 nH Chip Inductor	BK2125HM471-T	Taiyo Yuden
R1	0 Ω Chip Resistor	ERJ3GEY0R00V	Panasonic

LIFETIME BUY

LAST ORDER 24 MAY 14 LAST SHIP 24 MAY 15

50 OHM APPLICATION CIRCUIT: 300-3600 MHz

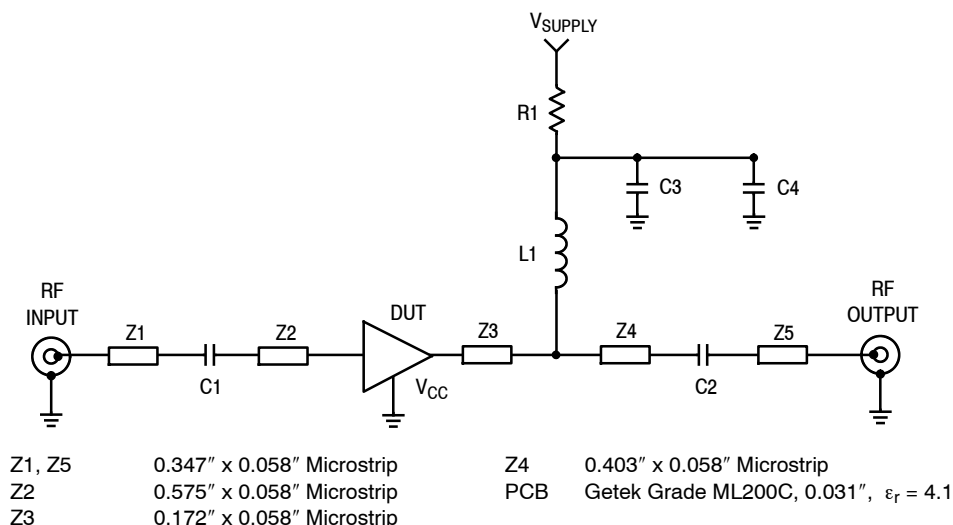

Figure 17. 50 Ohm Test Circuit Schematic

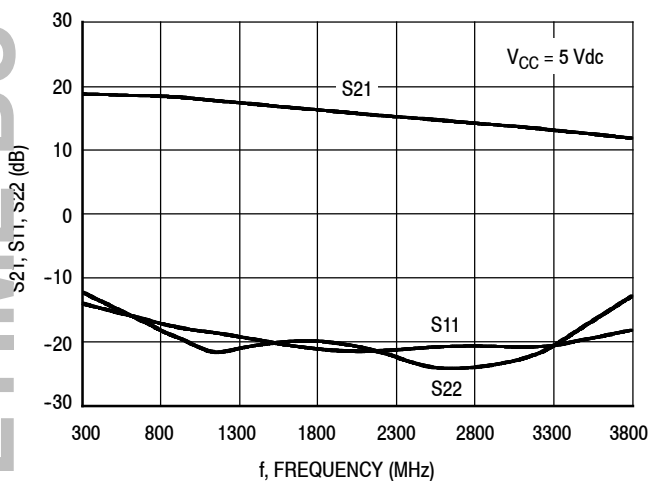

Figure 18. S21, S11 and S22 versus Frequency

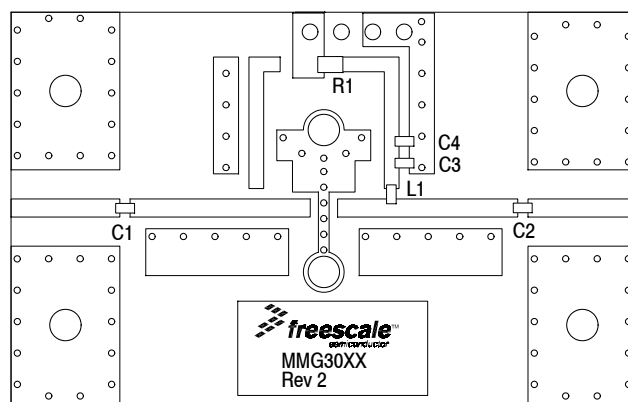

Figure 19. 50 Ohm Test Circuit Component Layout

Table 9. 50 Ohm Test Circuit Component Designations and Values

Part	Description	Part Number	Manufacturer
C1, C2	150 pF Chip Capacitors	C0603C151J5RAC	Kemet
C3	0.01 μ F Chip Capacitor	C0603C103J5RAC	Kemet
C4	1000 pF Chip Capacitor	C0603C102J5RAC	Kemet
L1	56 nH Chip Inductor	HK160856NJ-T	Taiyo Yuden
R1	0 Ω Chip Resistor	ERJ3GEY0R00V	Panasonic

LIFETIME BUY

LAST ORDER 24 MAY 14 LAST SHIP 24 MAY 15

50 OHM TYPICAL CHARACTERISTICS

Table 10. Common Emitter S-Parameters ($V_{CC} = 5 \text{ Vdc}$, $T_A = 25^\circ\text{C}$, 50 Ohm System)

f MHz	S ₁₁		S ₂₁		S ₁₂		S ₂₂	
	S ₁₁	∠ φ	S ₂₁	∠ φ	S ₁₂	∠ φ	S ₂₂	∠ φ
100	0.03723	-157.139	9.53422	174.957	0.07125	-0.244	0.15383	-9.473
150	0.03824	-159.784	9.45692	172.557	0.07151	-0.321	0.15195	-11.4
200	0.03924	-161.141	9.38250	169.351	0.07173	-0.527	0.15038	-15.453
250	0.03984	-163.743	9.30193	166.775	0.07196	-0.705	0.14855	-20.132
300	0.04044	-165.433	9.23472	164.195	0.07227	-0.968	0.14665	-25.238
350	0.04154	-167.556	9.16107	161.651	0.07249	-1.121	0.14473	-29.059
400	0.04218	-169.996	9.08796	159.059	0.07267	-1.321	0.14297	-33.099
450	0.04330	-171.505	9.01503	156.523	0.07303	-1.54	0.14282	-37.115
500	0.04391	-173.121	8.93887	153.864	0.07333	-1.729	0.14257	-40.95
550	0.04504	-175.107	8.86645	151.441	0.07360	-1.953	0.14246	-45.011
600	0.04579	-177.279	8.79137	148.941	0.07384	-2.108	0.14236	-48.838
650	0.04639	-179.085	8.72227	146.469	0.07422	-2.436	0.14207	-52.786
700	0.04725	178.481	8.65074	144.076	0.07453	-2.667	0.14191	-56.644
750	0.04874	176.513	8.57600	141.652	0.07485	-2.877	0.14153	-60.456
800	0.05044	174.578	8.49615	139.244	0.07535	-3.216	0.13860	-64.47
850	0.05265	172.441	8.41904	136.846	0.07573	-3.535	0.13706	-68.268
900	0.05446	170.794	8.33301	134.487	0.07615	-3.858	0.13387	-72.153
950	0.05671	168.866	8.24325	132.225	0.07660	-4.215	0.13169	-76.394
1000	0.05987	166.015	8.16300	129.928	0.07706	-4.628	0.12795	-80.615
1050	0.06338	164.827	8.06445	127.713	0.07745	-5.024	0.12512	-84.753
1100	0.06818	162.719	7.97785	125.419	0.07782	-5.308	0.12243	-89.314
1150	0.07156	160.419	7.88628	123.146	0.07832	-5.91	0.11969	-94.022
1200	0.07622	158.869	7.79192	120.927	0.07888	-6.277	0.11711	-98.985
1250	0.08148	156.417	7.70036	118.767	0.07940	-6.79	0.11465	-104.195
1300	0.08625	154.855	7.61312	116.644	0.07998	-7.245	0.11217	-109.672
1350	0.08847	152.545	7.52137	114.548	0.08040	-7.843	0.10841	-114.968
1400	0.09042	150.239	7.43401	112.485	0.08082	-8.299	0.10615	-120.795
1450	0.09247	148.043	7.33853	110.413	0.08128	-8.836	0.10380	-126.657
1500	0.09461	146.969	7.25672	108.381	0.08193	-9.303	0.10158	-128.442
1550	0.09681	144.023	7.16705	106.399	0.08243	-9.992	0.10048	-133.06
1600	0.09928	141.737	7.08702	104.396	0.08305	-10.464	0.09950	-138.358
1650	0.10270	139.246	6.98699	102.42	0.08347	-11.112	0.09874	-142.307
1700	0.10530	137.14	6.90998	100.459	0.08398	-11.668	0.09873	-147.8
1750	0.10836	134.919	6.82646	98.556	0.08445	-12.336	0.09872	-152.853
1800	0.11174	132.496	6.74375	96.678	0.08491	-12.894	0.09935	-157.527
1850	0.11560	130.26	6.65836	94.774	0.08539	-13.604	0.09998	-162.646
1900	0.11980	128.189	6.57651	92.937	0.08590	-14.2	0.10150	-167.628
1950	0.12349	126.377	6.49376	91.045	0.08640	-14.843	0.10335	-172.451
2000	0.12873	124.287	6.41028	89.21	0.08693	-15.588	0.10540	-176.909
2050	0.13268	121.985	6.33373	87.389	0.08742	-16.17	0.10798	178.048
2100	0.13725	120.2	6.25726	85.623	0.08786	-16.886	0.11081	174.074
2150	0.14017	118.487	6.18534	83.864	0.08852	-17.695	0.11466	169.543
2200	0.14638	116.403	6.10210	82.117	0.08869	-18.285	0.11714	166.109
2250	0.15016	114.638	6.02971	80.32	0.08941	-19.001	0.12062	161.975

(continued)

MMG3008NT1

LIFETIME BUY

LAST ORDER 24 MAY 14 LAST SHIP 24 MAY 15

50 OHM TYPICAL CHARACTERISTICS

Table 10. Common Emitter S-Parameters ($V_{CC} = 5 \text{ Vdc}$, $T_A = 25^\circ\text{C}$, 50 Ohm System) (continued)

f MHz	S ₁₁		S ₂₁		S ₁₂		S ₂₂	
	S ₁₁	∠ φ	S ₂₁	∠ φ	S ₁₂	∠ φ	S ₂₂	∠ φ
2300	0.15521	112.618	5.95603	78.605	0.08986	-19.642	0.12414	158.434
2350	0.15976	110.76	5.88332	76.922	0.09022	-20.411	0.12774	155.044
2400	0.16414	109.067	5.81205	75.215	0.09063	-21.132	0.13152	151.453
2450	0.16931	107.269	5.74220	73.556	0.09110	-21.914	0.13622	148.114
2500	0.17290	105.625	5.67374	71.895	0.09160	-22.568	0.13975	145.204
2550	0.17697	103.866	5.60911	70.217	0.09197	-23.366	0.14370	142.104
2600	0.18119	102.097	5.54039	68.601	0.09243	-24.135	0.14796	139.028
2650	0.18491	100.467	5.48069	66.985	0.09288	-24.891	0.15201	136.155
2700	0.18871	98.781	5.41580	65.359	0.09335	-25.672	0.15562	133.387
2750	0.19276	97.217	5.35397	63.725	0.09367	-26.386	0.16040	130.458
2800	0.19700	95.483	5.29285	62.113	0.09412	-27.158	0.16438	127.735
2850	0.20042	93.791	5.23322	60.504	0.09452	-28.071	0.16843	124.907
2900	0.20441	92.231	5.17959	58.977	0.09485	-28.821	0.17329	122.375
2950	0.20776	90.583	5.11646	57.358	0.09546	-29.704	0.17724	119.612
3000	0.21089	89.007	5.06803	55.76	0.09593	-30.551	0.18220	116.735
3050	0.21615	87.21	5.01467	54.217	0.09605	-31.388	0.18674	114.476
3100	0.21938	85.618	4.95573	52.66	0.09660	-32.161	0.19068	111.831
3150	0.22294	84.139	4.90100	51.117	0.09698	-33.041	0.19574	109.296
3200	0.22712	82.548	4.85380	49.552	0.09728	-33.934	0.20063	106.823
3250	0.23123	80.985	4.80281	47.99	0.09759	-34.778	0.20541	104.361
3300	0.23510	79.448	4.75341	46.438	0.09808	-35.752	0.21019	101.936
3350	0.23920	77.951	4.70392	44.903	0.09840	-36.597	0.21526	99.673
3400	0.24357	76.439	4.65357	43.375	0.09872	-37.435	0.22065	97.38
3450	0.24799	75.054	4.60593	41.828	0.09894	-38.395	0.22551	95.15
3500	0.25252	73.636	4.55940	40.312	0.09929	-39.286	0.23111	92.952
3550	0.25708	72.232	4.51351	38.767	0.09959	-40.173	0.23653	90.83
3600	0.26176	70.859	4.46687	37.242	0.09973	-41.064	0.24174	88.712

LIFETIME BUY

LAST ORDER 24 MAY 14 LAST SHIP 24 MAY 15

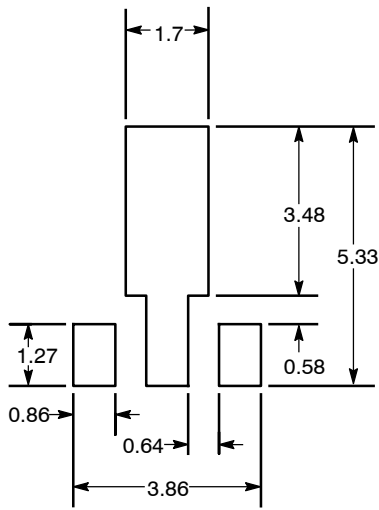

Recommended Solder Stencil

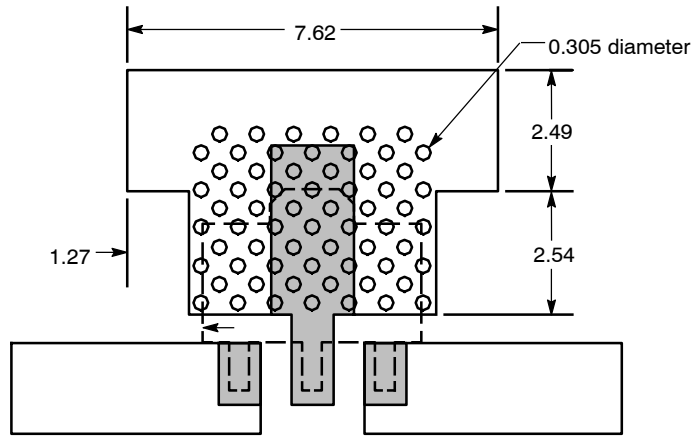

NOTES:

1. THERMAL AND RF GROUNDING CONSIDERATIONS SHOULD BE USED IN PCB LAYOUT DESIGN.
2. DEPENDING ON PCB DESIGN RULES, AS MANY VIAS AS POSSIBLE SHOULD BE PLACED ON THE LANDING PATTERN.
3. IF VIAS CANNOT BE PLACED ON THE LANDING PATTERN, THEN AS MANY VIAS AS POSSIBLE SHOULD BE PLACED AS CLOSE TO THE LANDING PATTERN AS POSSIBLE FOR OPTIMAL THERMAL AND RF PERFORMANCE.
4. RECOMMENDED VIA PATTERN SHOWN HAS 0.381 x 0.762 MM PITCH.

Figure 20. Recommended Mounting Configuration

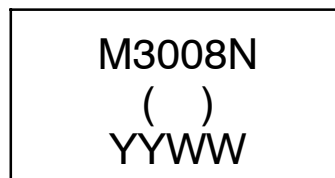
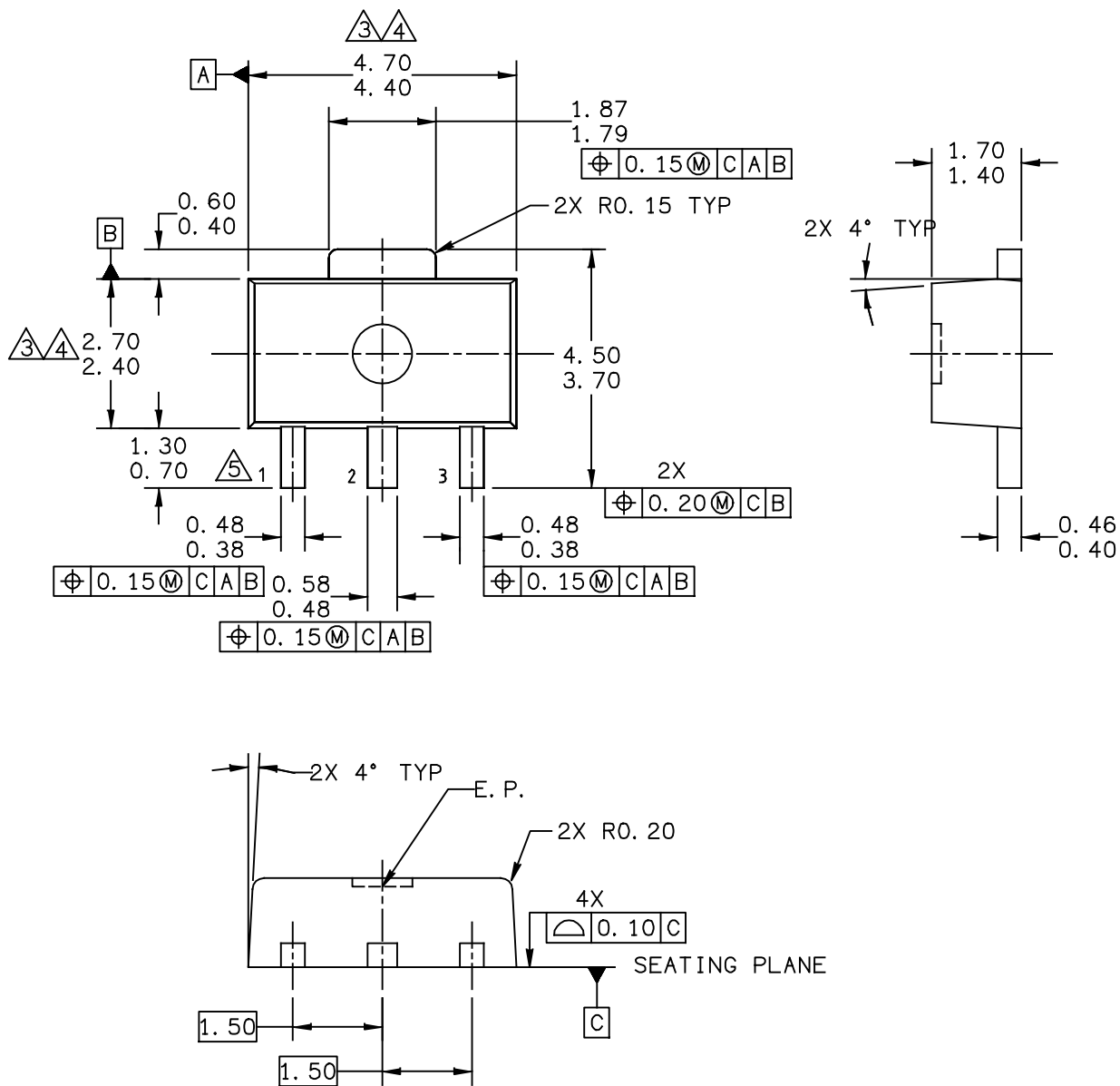
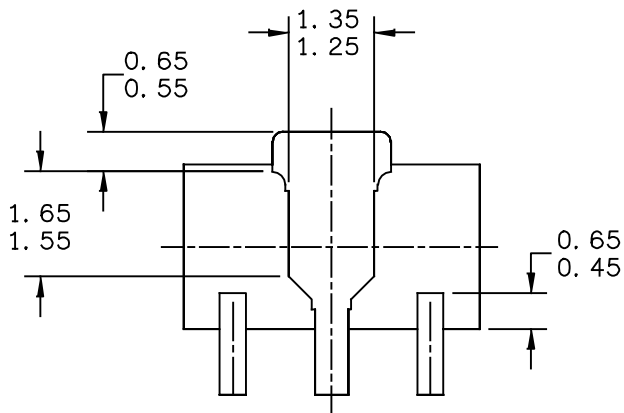

Figure 21. Product Marking

PACKAGE DIMENSIONS



© FREESCALE SEMICONDUCTOR, INC. ALL RIGHTS RESERVED.	MECHANICAL OUTLINE	PRINT VERSION NOT TO SCALE	
TITLE: SOT-89, 4 LEAD, 4.5 X 2.5 PKG, 1.5 MM PITCH	DOCUMENT NO: 98ASA10586D	REV: D	
	CASE NUMBER: 1514-02	27 JUN 2007	
	STANDARD: NON-JEDEC		



BOTTOM VIEW

CASE STYLE:

STYLE 1:

PIN 1. RF INPUT
 PIN 2. GROUND
 PIN 3. RF OUTPUT

STYLE 2:

PIN 1. GATE
 PIN 2. SOURCE
 PIN 3. DRAIN

© FREESCALE SEMICONDUCTOR, INC. ALL RIGHTS RESERVED.	MECHANICAL OUTLINE	PRINT VERSION NOT TO SCALE	
TITLE: SOT-89, 4 LEAD, 4.5 X 2.5 PKG, 1.5 MM PITCH	DOCUMENT NO: 98ASA10586D	REV: D	
	CASE NUMBER: 1514-02	27 JUN 2007	
	STANDARD: NON-JEDEC		

NOTES:

1 DIMENSIONING AND TOLERANCING PER ASME Y14.5M – 1994.

2 ALL DIMENSIONS ARE IN MILLIMETERS.

3 DIMENSIONS DOES NOT INCLUDE MOLD FLASH. PROTRUSIONS OR GATE BURRS. MOLD FLASH, PROTRUSIONS OR GATE BURRS SHALL NOT EXCEED 0.5mm PER END. DIMENSION DOES NOT INCLUDE INTERLEAD FLASH OR PROTRUSION. INTERLEAD FLASH OR PROTRUSION SHALL NOT EXCEED 0.5 mm PER SIDE.

4 DIMENSION ARE DETERMINED AT THE OUTMOST EXTREMES OF THE PLASTIC BODY EXCLUSIVE OF MOLD FLASH, TIE BAR BURRS, GATE BURRS AND INTERLEAD FLASH, BUT INCLUDING ANY MISMATCH BETWEEN THE TOP AND BOTTOM OF THE PLASTIC BODY.

5 TERMINAL NUMBERS ARE SHOWN FOR REFERENCE ONLY.

© FREESCALE SEMICONDUCTOR, INC. ALL RIGHTS RESERVED.	MECHANICAL OUTLINE	PRINT VERSION NOT TO SCALE	
TITLE: SOT-89, 4 LEAD, 4.5 X 2.5 PKG, 1.5 MM PITCH	DOCUMENT NO: 98ASA10586D	REV: D	
	CASE NUMBER: 1514-02	27 JUN 2007	
	STANDARD: NON-JEDEC		

PRODUCT DOCUMENTATION, SOFTWARE AND TOOLS

Refer to the following resources to aid your design process.

Application Notes

- AN1955: Thermal Measurement Methodology of RF Power Amplifiers
- AN3100: General Purpose Amplifier and MMIC Biasing

Software

- .s2p File

Development Tools

- Printed Circuit Boards

For Software and Tools, do a Part Number search at <http://www.freescale.com>, and select the “Part Number” link. Go to Software & Tools on the part’s Product Summary page to download the respective tool.

REVISION HISTORY

The following table summarizes revisions to this document.

Revision	Date	Description
3	Mar. 2007	<ul style="list-style-type: none">• Corrected and updated Part Numbers in Tables 8 and 9, Component Designations and Values, to RoHS compliant part numbers, pp. 6, 7
4	July 2007	<ul style="list-style-type: none">• Replaced Case Outline 1514-01 with 1514-02, Issue D, pp. 1, 11-13. Case updated to add missing dimension for Pin 1 and Pin 3.
5	Mar. 2008	<ul style="list-style-type: none">• Removed Footnote 2, Continuous voltage and current applied to device, from Table 2, Maximum Ratings, p. 1• Corrected Fig. 13, Single-Carrier W-CDMA Adjacent Channel Power Ratio versus Output Power y-axis (ACPR) unit of measure to dBc, p. 5• Corrected S-Parameter table frequency column label to read “MHz” versus “GHz” and corrected frequency values from GHz to MHz, pp. 8, 9
6	Feb. 2012	<ul style="list-style-type: none">• Corrected temperature at which Theta_{JC} is measured from 25°C to 86°C and added “no RF applied” to Thermal Characteristics table to indicate that thermal characterization is performed under DC test with no RF signal applied, p. 1• Table 6, ESD Protection Characterization, removed the word “Minimum” after the ESD class rating. ESD ratings are characterized during new product development but are not 100% tested during production. ESD ratings provided in the data sheet are intended to be used as a guideline when handling ESD sensitive devices, p. 3• Removed I_{CC} bias callout from applicable graphs and Table 10, Common Emitter S-Parameters heading as bias is not a controlled value, pp. 4-9• Added .s2p File availability to Product Software and Printed Circuit Boards to Development Tools, p. 14
7	Sept. 2014	<ul style="list-style-type: none">• Added Fig. 21, Product Marking, p. 9

MMG3008NT1

LIFETIME BUY

LAST ORDER 24 MAY 14 LAST SHIP 24 MAY 15

How to Reach Us:

Home Page:
freescale.com

Web Support:
freescale.com/support

Information in this document is provided solely to enable system and software implementers to use Freescale products. There are no express or implied copyright licenses granted hereunder to design or fabricate any integrated circuits based on the information in this document.

Freescale reserves the right to make changes without further notice to any products herein. Freescale makes no warranty, representation, or guarantee regarding the suitability of its products for any particular purpose, nor does Freescale assume any liability arising out of the application or use of any product or circuit, and specifically disclaims any and all liability, including without limitation consequential or incidental damages. "Typical" parameters that may be provided in Freescale data sheets and/or specifications can and do vary in different applications, and actual performance may vary over time. All operating parameters, including "typicals," must be validated for each customer application by customer's technical experts. Freescale does not convey any license under its patent rights nor the rights of others. Freescale sells products pursuant to standard terms and conditions of sale, which can be found at the following address: freescale.com/SalesTermsandConditions.

Freescale and the Freescale logo are trademarks of Freescale Semiconductor, Inc., Reg. U.S. Pat. & Tm. Off. All other product or service names are the property of their respective owners.

© 2005–2008, 2012, 2014 Freescale Semiconductor, Inc.

