

Manufacturing Notes for RFPA3807

The information in this publication is believed to be accurate and reliable. However, no responsibility is assumed by RF Micro Devices, Inc. ("RFMD") for its use, nor for any infringement of patents, or other rights of third parties, resulting from its use. No license is granted by implication or otherwise under any patent or patent rights of RFMD. RFMD reserves the right to change component circuitry, recommended application circuitry and specifications at any time without prior notice.

RoHS status based on EUDirective2002/95/EC (at time of this document revision).

Table of Contents

1.	Introduction	2
2.	Small Outline Transistor Package Description	2
2.1	RFPA3807 Outline Drawing	2
2.2	RFPA3807 Branding Diagram	2
3.	Carriers	3
3.1	Tape and Reel	3
4.	Storage and Handling	4
4.1	ESD	4
4.2	Moisture Sensitivity Level (MSL)	4
4.2.1	Storage Conditions	4
4.2.2	Out-of-Bag Time Duration	4
4.2.3	Baking	5
5.	Assembly Guidelines	6
5.1	Stencil Design Recommendation	6
5.2	Solder Reflow Recommendation	8
5.2.1	Solder Reflow Equipment	8
5.2.2	Reflow Profile Notes	8
5.2.3	Low Temperature Reflow Profile	8
5.2.4	High Temperature Reflow Profile	9
5.2.5	Solder Paste	10
5.2.6	Inspection	10
6.	Part Removal/Rework	11
6.1	Removal Method	11
6.2	Replacement Method	11
7.	Summary Information	12
8.	Revision History	12

1. Introduction

This manufacturing note is intended for surface mount technology (SMT) manufacturing engineers who are currently using the RFPA3807 for prototype or production manufacturing. The information provided in this document is meant to assist customers with the set-up and characterization of their products.

2. Small Outline Transistor Package Description

A small outline transistor (SOT) package is a plastic encapsulated surface mount type device. The input and output terminations are in the gull wing form plated with solder (Matte-Sn (tin); 8-20 μm thickness) on a Cu base. These are typically single chip carriers and can come in 3, 5, 6, and 8 lead configurations.

2.1 RFPA3807 Outline Drawing

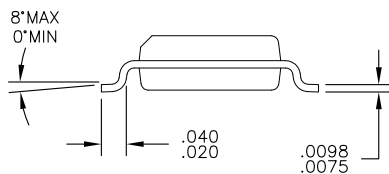
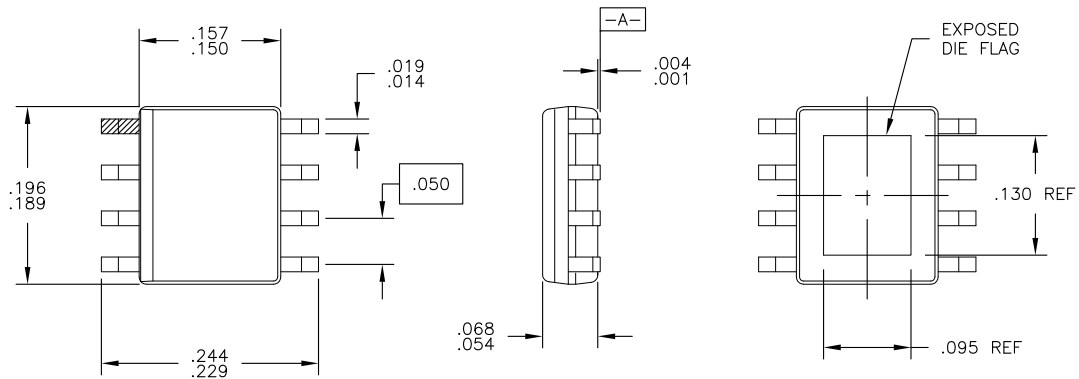

- NOTES:
1. SHADED LEAD IS PIN 1.
 2. LEAD COPLANARITY: .003 WITH RESPECT TO DATUM 'A'.
 3. DIMENSIONS DO NOT INCLUDE MOLD FLASH OR PROTRUSIONS.

2.2 RFPA3807 Branding Diagram

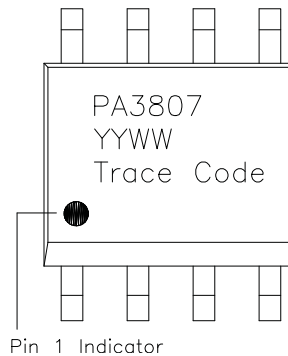

If included on branding diagram, YY indicates year; WW indicates work week; and Trace Code is a sequential number assigned at device assembly.

3. Carriers

3.1 Tape and Reel

Carrier tape basic dimensions are based on EIA 481. The pocket is designed to hold the part for shipping and loading onto SMT manufacturing equipment, while protecting the body and the solder terminals from damaging stresses. The individual pocket design can vary from vendor to vendor, but width and pitch will be consistent.

Carrier tape is wound or placed onto a shipping reel either 330 mm (13 inches) in diameter or 178 mm (7 inches) in diameter. The center hub design is large enough to ensure the radius formed by the carrier tape around it does not put unnecessary stress on the parts.

Prior to shipping, moisture sensitive parts (MSL level 2a-5a) are baked and placed into the pockets of the carrier tape. A cover tape is sealed over the top of the entire length of the carrier tape. The reel is sealed in a moisture barrier ESD bag with the appropriate units of desiccant and a humidity indicator card, which is placed in a cardboard shipping box. It is important to note that unused moisture sensitive parts need to be resealed in the moisture barrier bag. If the reels exceed the exposure limit and need to be rebaked, most carrier tape and shipping reels are not rated as bakeable at 125°C. If baking is required, devices may be baked according to section 4, table 4-1, of Joint Industry Standard IPC/JEDEC J-STD-033.

Table 1 provides useful information for carrier tape and reels used for shipping the devices described in this document.

Table 1. Tape and Reel

RFMD Part Number	Reel Diameter Inch (mm)	Hub Diameter Inch (mm)	Width (mm)	Pocket Pitch (mm)	Feed	Units per Reel
RFPA3807TR13	13 (330)	4 (102)	12	8	Single	2500
RFPA3807TR7	7 (178)	2.4 (61)	12	8	Single	750

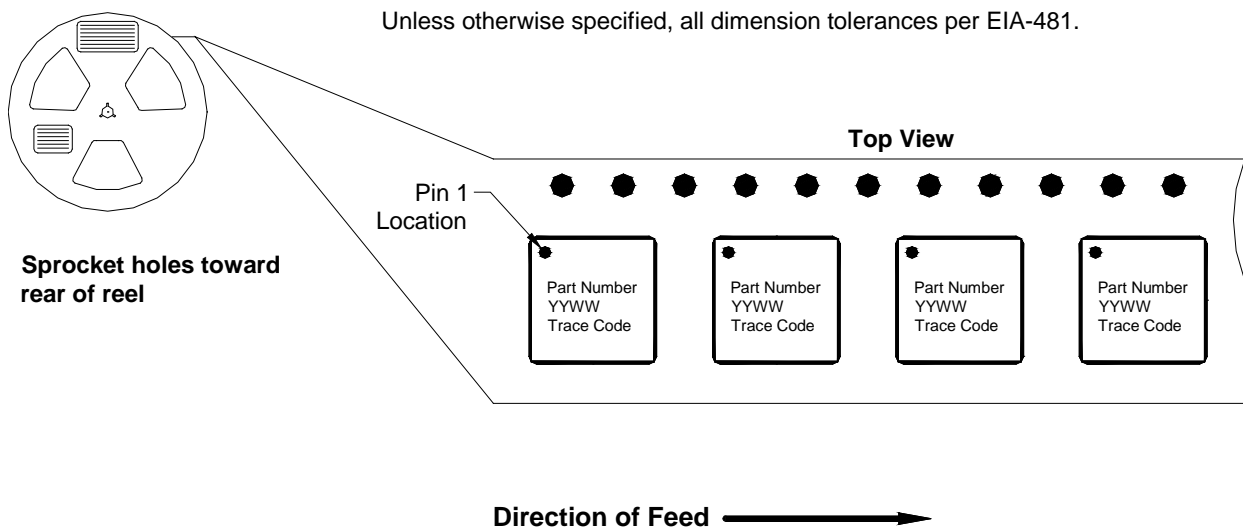

Figure 1. 0.157mm x 0.196mm (Carrier Tape Drawing with Part Orientation)

4. Storage and Handling

4.1 ESD

Electrostatic discharge occurs naturally in the environment. With the increase in voltage potential, the outlets of neutralization or discharge will be sought. If the acquired discharge route is through a semiconductor device, destructive damage will result.

ESD countermeasure methods should be developed and used to control potential ESD damage during handling in a factory environment at each manufacturing site.

RFPA3807 is considered ESD sensitive and needs to be handled accordingly.

RFMD recommends utilizing standard ESD precautions (see Reference Documents) when handling these devices.

Reference Documents:

1. JEDEC Standard JESD625-A, "Requirements for Handling Electrostatic-Discharge-Sensitive (ESDS) Devices."
2. ANSI/ESD S20.20, "Protection of Electrical and Electronic Parts, Assemblies and Equipment (Excluding Electrically Initiated Explosive Devices)."

NOTE: The RFPA3807 ESD level is documented in the product qualification report that is available from RFMD.

4.2 Moisture Sensitivity Level (MSL)

RFPA3807 is a moisture sensitive part. RFMD marks the MSL level and peak reflow temperature for the device on each shipping bag and reel label. It is important that the parts are handled according to the conditions indicated.

The handling, baking, and floor life requirements of moisture sensitive parts are discussed in section 4, section 5, and section 6 of Joint Industry Standard IPC/JEDEC J-STD-033. RFMD qualifies the MSL of each device in accordance with the reflow profile found in the Joint Industry Standard IPC/JEDEC J-STD-020.

If moisture sensitive parts are not applied to a board within the maximum "out-of-bag" or floor life exposure time, then the parts must be baked according to section 4, table 4-1 of Joint Industry Standard IPC/JEDEC J-STD-033 to remove any moisture absorbed into the part. The floor life exposures can be extended by storing open component reels in nitrogen or dry air storage cabinets when not in use.

Prior to any rework it is highly recommended that the PCB be baked in a calibrated oven/chamber for 24 hours at 125 °C to remove moisture from assembly. The pre-bake will prevent damage to any components due to moisture vapor pressures caused during rework. See section 7 for additional details on rework procedures.

Reference Documents:

1. IPC/JEDEC J-STD-033, "Joint Industry Standard Handling, Packing, Shipping, and Use of Moisture/Reflow Sensitive Surface Mount Devices."
2. IPC/JEDEC J-STD-020, "Joint Industry Standard Moisture/Reflow Sensitivity Classification for NonHermetic Solid State Surface Mount Devices."

NOTE: The RFPA3807 MSL level is documented in the product qualification report that is available from RFMD.

4.2.1 Storage Conditions

Packages described in this document must be stored in sealed moisture barrier, anti-static bags. Shelf life in a sealed moisture barrier bag is 12 months at < 40 °C and < 90% relative humidity (RH).

4.2.2 Out-of-Bag Time Duration

After unpacking, the device must be soldered to the PCB within the time listed on the moisture barrier bag label. If the parts are provided in a tape and reel configuration, reels that have not been opened are considered unused. If multiple reels are provided per bag, the reels should be removed one at a time and the remaining reels resealed. Any unused parts may be returned to the shelf and stored for later use, but the out-of-bag exposure time allowed for the parts will have been reduced by the time previously out of the bag.

4.2.3 Baking

It is not necessary to bake the parts if both above conditions have been satisfied.

Baking must be done if at least one of the conditions described in sections 4.2.1 or 4.2.2 has not been satisfied. Refer to JEDEC J-STD-033 for baking requirements.

Caution: Tape and reel materials typically must be baked for a longer time at lower temperatures. If baking is required, devices may be baked according to section 4, table 4-1, of Joint Industry Standard IPC/JEDEC J-STD-033.

5. Assembly Guidelines

5.1 Stencil Design Recommendation

The PCB pad pattern designs suggested in the component data sheets are important to successful part mounting and reliability. In addition to the PCB layout, printed solder paste deposits are critical in achieving a reliable solder joint. Since surface mount processes vary from company to company, careful process development is recommended. The following provides some guidelines for stencil designs based on RFMD's experience in surface mounting these packages.

The stencil apertures are typically designed to match the PCB pad size and are decreased for an overall 10% reduction in paste area for each pad. This has yielded good solder joint results based on volumes assembled during the product introduction phase. To aid in the reduction of solder voids and out-gassing, smaller multiple openings in the stencil can be used instead of one large opening on the thermal pad region. However, eliminating voids completely may not be possible due to the presence of thermal vias and large component pads.

Critical parameters to consider for successful solder paste application include the following.

- Accurate registration of the stencil to the PCB during printing.
- Good release of the stencil from the PCB after paste is applied. This is improved with laser-cut trapezoidal openings.
- Proper storage and handling of solder paste based on solder paste vendor guidelines.
- Frequent cleaning of the solder paste stencil to remove residual solder paste.

Stencil material recommendations: 5 mil (0.127 mm) thick stainless steel and laser-cut stencils with trapezoidal openings to promote easy release of solder paste. The PCB pad pattern designs suggested in the component data sheets are important to successful part mounting and reliability. In addition to the PCB layout, printed solder paste deposits are critical in achieving a reliable solder joint. The stencil recommendation below is based on the PCB footprint design found in the product data sheet. Since surface mount processes vary from company to company, careful process development is recommended. The following provides some guidelines for stencil designs based on RFMD's experience in surface mounting these packages.

The stencil apertures are typically designed to match the PCB pad size and are decreased for an overall 10%-20% reduction in paste area for each pad. The thermal pad stencil aperture should be designed to achieve component standoff height of 2-3mils. This has yielded good solder joint results based on volumes assembled during the product introduction phase. To aid in the reduction of solder voids and out-gassing, smaller multiple openings in the stencil can be used instead of one large opening on the thermal pad region. However, eliminating voids completely may not be possible due to the presence of thermal vias and large component pads. Solder joint acceptability should be based on "Bottom Only Terminations" in IPC-A-610.

Critical parameters to consider for successful solder paste application include the following.

- Accurate registration of the stencil to the PCB during printing.
- Good release of the stencil from the PCB after paste is applied. This is improved with laser-cut trapezoidal openings.
- Proper storage and handling of solder paste based on solder paste vendor guidelines.
- Frequent cleaning of the solder paste stencil to remove residual solder paste.
- Stencil material recommendations: 5 mil (0.127 mm) thick stainless steel and laser-cut stencils with trapezoidal openings to promote easy release of solder paste.
- **NOTE:** For half-etch lead packages, the stencil apertures for the peripheral leads may be decreased due to less solderable area of the leads.

A = 1,215 x 0,495 (mm) Typ
B = 0,990 x 1,395 (mm) Typ

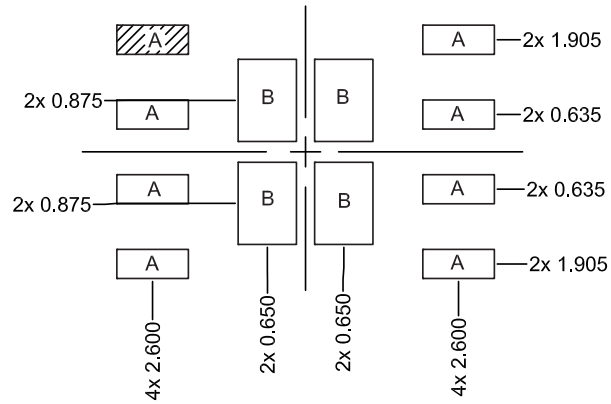

Note:
PIN 1 is shaded area.

Figure 2. Stencil Recommendation

5.2 Solder Reflow Recommendation

This information is provided as a guideline to facilitate the successful implementation of a surface mount process customized to the user's requirements.

5.2.1 Solder Reflow Equipment

Recommendations provided are based on a 100% convection reflow oven capable of maintaining temperatures specified in Joint Industry Standard IPC/JEDEC J-STD-020.

5.2.2 Reflow Profile Notes

An optimized reflow profile depends on several factors such as the solder paste, board density, and type of reflow equipment used. Additional reflow information can be obtained from solder paste vendor data sheets.

It is recommended that any reflow profile be characterized with a fully populated production PCB. Thermocouples can be used to record temperatures across the surface and any sensitive components on the PCB. Ensure that a thermocouple is placed in contact with the top surface of any moisture sensitive component to ensure maximum temperature is not exceeded.

5.2.3 Low Temperature Reflow Profile

Following are the specifications for a reflow profile for a maximum reflow temperature of 240°C. The temperature used to classify the MSL level appears on the MSL label on each shipping bag. RFMD uses reflow profiles in accordance with IPC/JEDEC J-STD-020 for qualification.

Ramp-up rate	3 °C/second max.
Preheat temperature 125 (±25)°C	120 seconds max.
Temperature maintained above 179°C	60-150 seconds
Time within 5 °C of actual peak temperature	10-30 seconds
Peak temperature range	240 +0/-5 °C
Ramp-down rate	6 °C/second max.
Time 25 °C to peak temperature	6 minutes max.
Maximum number of reflow cycles	≤ 3
Pre-baking requirements	Refer to JEDEC J-STD-033 if original device package is unsealed.
Maximum reflow temperature	240 °C

The RFMD recommended profile complies with the JEDEC standard with the exception that the melting point of the solder paste used during qualification has a melting point of 179°C versus 183°C. Temperature maintained above 179°C was 57 seconds to 60 seconds.

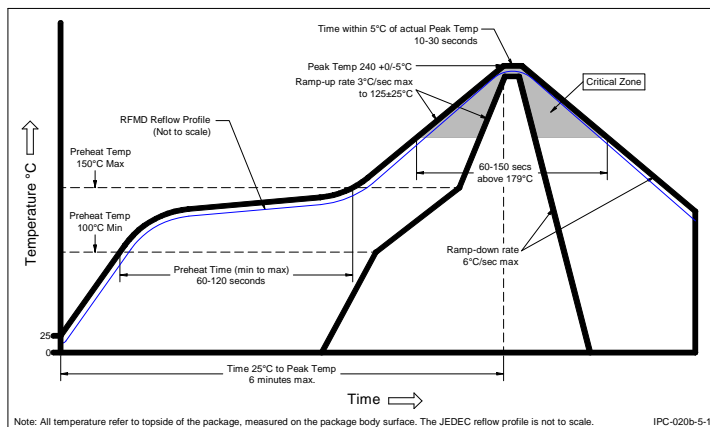

Figure 3. Typical Low Temperature Reflow Profile

5.2.4 High Temperature Reflow Profile

Maximum reflow temperature is 260 °C. The temperature used to classify the MSL level appears on the MSL label on each shipping bag. RFMD uses reflow profiles in accordance with IPC/JEDEC J-STD-020 for qualification with the exception of the maximum reflow temperature of 260 °C.

Ramp-up rate	3 °C/second max.
Preheat temperature 175 (±25) °C	180 seconds max.
Temperature maintained above 217 °C	60-150 seconds
Time within 5 °C of actual peak temperature	20-40 seconds
Peak temperature range	260 +0/-5 °C
Ramp-down rate	6 °C/second max.
Time 25 °C to peak temperature	8 minutes max.
Maximum number of reflow cycles	≤ 3
Pre-baking requirements	Refer to JEDEC J-STD-033 if original device package is unsealed.
Maximum reflow temperature	260 °C

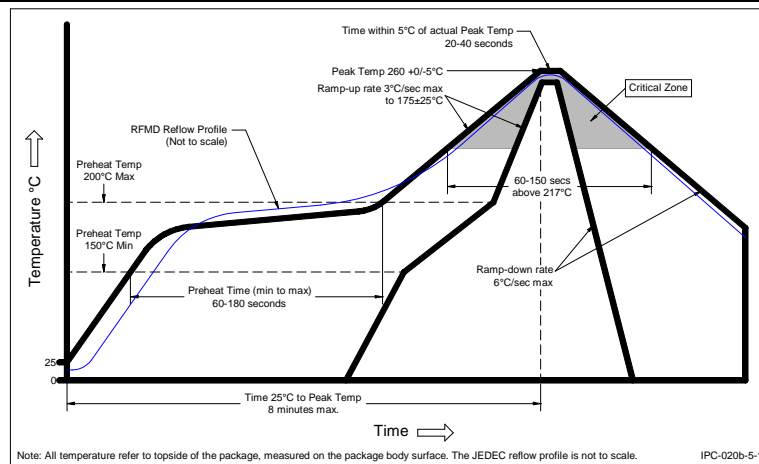

Figure 4. Typical High Temperature Reflow Profile

5.2.5 Solder Paste

Solder paste used for the RFMD low temperature reflow qualification.

Solder paste	Multicore RP11
Alloy type	Sn62/Pb36/Ag2
Metal content	89.5%
Solder particle size	45 μm to 20 μm

Solder paste used for the RFMD high temperature reflow qualification.

Solder paste	Multicore 96SCAGS89 (CR39)
Alloy type	Sn95.5/Ag3.8/Cu0.7
Metal content	88.5%
Solder particle size	45 μm to 20 μm

A no-clean, type 3 solder paste is recommended since it is difficult to completely clean residues under low profile components after they have been soldered to the PCB. Eliminating residues reduces the possibility of solder bridging between non-connected pads. This condition is affected by time, temperature, and humidity and will not be visible during initial inspection after reflow.

5.2.6 Inspection

It is recommended that x-ray inspection be performed for any solder joints that are not visible after assembly. The following analysis and inspection criteria have been shown to result in component attachments that pass all RFMD package qualification procedures:

- Evaluate solder paste printing process. Measure print height, and paste slump.
- Perform visual inspection for excess solder on terminal pads before and after reflow.
- Perform x-ray to inspect for proper alignment, solder voids, solder balls, and solder bridging after reflow.
- Check for a minimum of 80% solder coverage on pad.
- There should be complete solder coverage on ground pads directly under die locations in component.
- Inspect for solder bridging or splatter between I/O pads.

6. Part Removal/Rework

Prior to any rework it is highly recommended that the PCB be baked in a calibrated oven/chamber for 24 hours at 125° C to remove moisture from the assembly. The pre-bake will prevent damage to any components due to moisture vapor pressures caused during rework.

6.1 Removal Method

- It is recommended that a heat controlled rework station be used.
- The ideal reflow profile for part removal should match the one used for initial part attachment. Because the rework area is small, the duration of time the heat is applied after the solder reflows completely can be less than the original reflow profile as long as the preheat and soak times are the same as the original profile.
- The board should be heated from the bottom side using convective heaters to reduce thermal shock to the PCB.
- Hot air/gas tools fitted with special nozzles should be used to direct the heating to the component area being replaced and to avoid the heating of adjacent parts during rework.
- Excessive airflow should be avoided to prevent skew and disruption of adjacent components.
- A vacuum lift tool can be used to remove the component once all solder joints have reflowed. Special care must be taken to ensure total reflow and to prevent pad liftoff.
- Heat guns and soldering irons are not recommended for removal or rework.

6.2 Replacement Method

- Before replacing the component, the PCB land should be properly cleaned.
- Residual solder must be removed and the lands cleaned. The type of paste used in the original assembly determines the cleaning method.
- The preferred method for applying solder paste is a mini stencil that has the same thickness, aperture size and shape as the one used during initial assembly. The stencil is aligned to the pads and paste applied with a small metal squeegee blade. If space does not allow a mini stencil, paste can be dispensed directly to the PCB lands, however some process development is required to determine an appropriate amount of solder paste to ensure successful solder attachment.
- A no-clean, type 3 solder paste is recommended to prevent trapping residues under the component that cannot be cleaned after assembly.
- Placement of component can be done using magnification to check alignment. Placement equipment should have the ability to adjust X, Y, and Z coordinates and provide consistent alignment to pad and component placement pressure. Small packages will also have some self-centering characteristics due to small mass and will align themselves during reflow.
- The reflow profile used during the original assembly should be used to attach the new component. If different equipment or paste is used, the reflow profile will need to be optimized again.

7. Summary Information

Package size	0.157 mm x 0.196mm
Package thickness	0.068mm (maximum)
Package surface finish	Matte-Sn (tin); 8-20 µm thickness
Handling requirements	ESD sensitive; moisture sensitive (Ref. JESD625-A; IPC/JEDEC J-STD-033).
Shelf-life in bag	12 months at < 40°C and < 90% relative humidity
RoHS status	RoHS compliant

8. Revision History

Revision	Date	Description
A	08/10	Initial release.