



Features

- 35dB Typical Gain Across Frequency Band
- $P_{OUT} = 27.5\text{ dBm} < 2.5\% \text{ EVM}$
- 2.4GHz to 2.5GHz Frequency Range
- 1x1 MIMO architecture
- Integrated 3-stage PA, filtering, and T/R switch.
- Integrated power detector

Applications

- WiFi IEEE802.11b/g/n Applications
- Customer Premises Equipment (CPE)
- WiFi Access Points and Gateways
- Spread-Spectrum and MMDS Systems

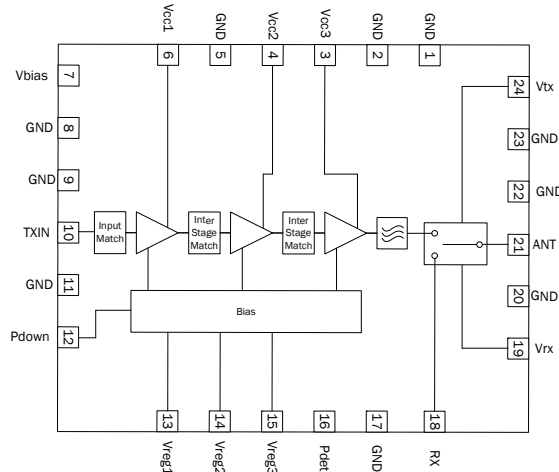

Functional Block Diagram

Product Description

RF5605 is a 1x1 MIMO module that is intently specified to address IEEE 802.11b/g/n WiFi 2.4GHz to 2.5GHz customer premises equipment (CPE) applications. The module has an integrated three-stage linear power amplifier, Tx harmonic filtering and SPDT switch. The RF5605 has fully matched input and output for a 50Ω system and incorporates matching networks optimized for linear output power and efficiency. The RF5605 is housed in a 6mm x 6mm laminate.

Ordering Information

RF5605PCK-410	RF5605 Eval Board with 5 piece Bag
RF5605SB	5 Piece Bag
RF5605SR	100 piece Reel
RF5605TR7	2500 piece reel
RF5605SQ	25 piece Bag

Optimum Technology Matching® Applied

- | | | | |
|---|--------------------------------------|--|------------------------------------|
| <input type="checkbox"/> GaAs HBT | <input type="checkbox"/> SiGe BiCMOS | <input checked="" type="checkbox"/> GaAs pHEMT | <input type="checkbox"/> GaN HEMT |
| <input type="checkbox"/> GaAs MESFET | <input type="checkbox"/> Si BiCMOS | <input type="checkbox"/> Si CMOS | <input type="checkbox"/> BIFET HBT |
| <input checked="" type="checkbox"/> InGaP HBT | <input type="checkbox"/> SiGe HBT | <input type="checkbox"/> Si BJT | <input type="checkbox"/> LDMOS |

RF MICRO DEVICES®, RFMD®, Optimum Technology Matching®, Enabling Wireless Connectivity™, PowerStart®, POLARIS™ TOTAL RADIO™ and UltimateBlue™ are trademarks of RFMD, LLC. BLUETOOTH is a trademark owned by Bluetooth SIG, Inc., U.S.A. and licensed for use by RFMD. All other trade names, trademarks and registered trademarks are the property of their respective owners. ©2006, RF Micro Devices, Inc.

Absolute Maximum Ratings

Parameter	Rating	Unit
Supply Voltage (RF Applied)	-0.5 to +5.25	V
Supply Voltage (No RF Applied)	-0.5 to +6.0	V
DC Supply Current (RMS)	1200	mA
Input RF Power with 50Ω Output Load.	+10	dBm
Maximum VSWR with no Damage	10:1	
Operating Ambient Temperature	-40 to +85	°C
Storage Temperature	-40 to +150	°C
Maximum Junction Temperature T_{J-MAX}	175	°C
Moisture Sensitivity	MSL3	



Caution! ESD sensitive device.

Exceeding any one or a combination of the Absolute Maximum Rating conditions may cause permanent damage to the device. Extended application of Absolute Maximum Rating conditions to the device may reduce device reliability. Specified typical performance or functional operation of the device under Absolute Maximum Rating conditions is not implied.

The information in this publication is believed to be accurate and reliable. However, no responsibility is assumed by RF Micro Devices, Inc. ("RFMD") for its use, nor for any infringement of patents, or other rights of third parties, resulting from its use. No license is granted by implication or otherwise under any patent or patent rights of RFMD. RFMD reserves the right to change component circuitry, recommended application circuitry and specifications at any time without prior notice.



RFMD Green: RoHS compliant per EU Directive 2002/95/EC, halogen free per IEC 61249-2-21, < 1000 ppm each of antimony trioxide in polymeric materials and red phosphorus as a flame retardant, and <2% antimony in solder.

Parameter	Specification			Unit	Condition
	Min.	Typ.	Max.		
Typical Conditions					T=25 °C, V _{CC} =5.0V, V _{REG} =2.85V, using an IEEE802.11g waveform, 54Mbps, unless otherwise noted
Tx Performance - 11g/n					Compliance with standard 802.11g/n
Frequency	2412		2484	MHz	
802.11n Output Power	26.5	27		dBm	802.11n HT20 and HT40 MCS7
11n EVM		2.5	3	%	
802.11g Output Power	27	27.5		dBm	802.11g 64QAM 54Mbps
11g EVM		2.5	3	%	
Second Harmonic		-40	-32	dBm/MHz	At rated P _{OUT}
Third Harmonic		-50	-40	dBm/MHz	At rated P _{OUT}
Tx Performance - 11b					Compliance with standard 802.11b
802.11b output power	28.5	29		dBm	802.11b 1MBps
ACP1		-36	-32	dBc	802.11b 1MBps
ACP2		-56	-52	dBc	802.11b 1MBps
Tx Performance - Generic					
Gain	32	35	37	dB	
Gain variation over Temp			+/-2.5	dB	Over temperature of -40°C to +85°C
Low Gain Mode - gain reduction		23		dB	Drop in gain versus high gain mode by setting V _{REG2} =0
Power Detect Range	0.2		1.7	V	P _{OUT} =0dBm to 30dBm
Power Detect Voltage		1.25		V	At rated P _{OUT}
Input Return Loss at TX_IN pin	10	15		dB	In specified frequency band
Output Return Loss at ANT pin	7	9		dB	In specified frequency band
Operating Current		900	1000	mA	At rated P _{OUT}
Quiescent Current		525	600	mA	V _{CC} =5.0, V _{REG} =2.85V and RF=OFF
PAE (Power Added Efficiency)		17		%	At rated P _{OUT} (PA only)
I _{REG}		7	10	mA	in Tx mode
P _{DOWN} Current - V _{REG} supply		10	12.5	mA	P _{DOWN} =0V, V _{REG} =2.85V, V _{CC} =5V
P _{DOWN} Current - V _{CC} Supply		1.7	2.5	mA	P _{DOWN} =0V, V _{REG} =2.85V, V _{CC} =5V
Leakage Current		0.4	1	mA	V _{CC} =5V, V _{REG} =0V, P _{DOWN} =0V
Power Supply - V _{CC}		5	5.25	V	

Parameter	Specification			Unit	Condition
	Min.	Typ.	Max.		
Tx Performance - Generic (continued)					
Power supply - V_{REG1} , V_{REG2} , V_{REG3}	2.75	2.85	2.95	V	
Turn-on time from setting of V_{REGS}			400	nsec	Output stable to within 90% of final gain
Turn-off time from setting of V_{REGS}			800	nsec	Output stable to within 90% of final gain
Stability at P_{OUT}	-25		33.5	dBm	No spurs above -47 dBm into 4:1 VSWR
CW P1dB		33.5		dBm	Tx mode in 50% Duty Cycle
Rx Performance					
Rx Insertion Loss - Rx		0.8	1	dB	
Noise Figure		0.8	1	dB	In specified frequency band
Return Loss - Rx	10	16		dB	
Rx to ANT isolation while in Tx mode		30		dB	
Rx to Tx isolation while in Tx mode	25	30		dB	
Generic Performance					
T/R switching time			0.5	μ sec	
Voltage Logic High	2.75	2.85	3.4	V	
Voltage Logic Low	0		0.3	V	
Control Current - Logic High		1	10	μ A	
Thermal					
R_{THJ}		15		$^{\circ}$ C/Watt	
ESD					
Human Body Model	500			V	EIA/JESD22-114A RF pins
	500			V	EIA/JESD22-114A DC pins
Charge Device Model	1000			V	JESD22-C101C all pins

RF5605 Tx/Rx Control Truth Table

Status	PDOWN	VTX	VRX
Tx Mode	High	High	Low
Rx mode	Low	Low	High

Pin Names and Descriptions

Pin	Name	Description
1	GND	Ground connection
2	GND	Ground connection
3	VCC3	This pin is connected internally to the collector of the 3rd stage RF device. To achieve specified performance, the layout of these pins should match the Recommended Land Pattern.
4	VCC2	This pin is connected internally to the collector of the 2nd stage RF device. To achieve specified performance, the layout of these pins should match the Recommended Land Pattern.
5	GND	Ground connection
6	VCC1	This pin is connected internally to the collector of the 1st stage RF device. To achieve specified performance, the layout of these pins should match the Recommended Land Pattern.
7	VBIAS	Supply voltage for the bias reference and control circuits.
8	GND	Ground connection
9	GND	Ground connection
10	TXIN	RF input is internally matched to 50Ω and DC blocked.
11	GND	Ground connection
12	PDOWN	Power down pin. Apply $<0.3V_{DC}$ to power down the three power amplifier stages. Apply $1.75V_{DC}$ to $5.0V_{DC}$ to power up. If function is not desired, Pin may be connected to V_{REG} .
13	VREG1	First stage bias voltage. This Pin requires regulated supply for best performance.
14	VREG2	Second stage bias voltage. This Pin requires regulated supply for best performance.
15	VREG3	Third stage bias voltage. This Pin requires regulated supply for best performance.
16	PDET	Power detector provides an output voltage proportional to the RF output power level.
17	GND	Ground connection
18	RX	RF Output is internally matched to 50Ω and DC blocked.
19	VRX	Switch control for Rx mode
20	GND	Ground connection
21	ANT	RF Output is internally matched to 50Ω and DC blocked.
22	GND	Ground connection
23	GND	Ground connection
24	VTX	Switch control for Tx mode
PkG Base	GND	Ground connection

Theory of Operation and Applications

Overview

The RF5605 is a single-chip integrated front end module (FEM) for high performance WiFi applications in the 2.4GHz to 2.5GHz ISM band. The FEM greatly reduces the number of external components minimizing footprint and assembly cost of the overall 802.11b/g/n solution. The RF5605 has an integrated b/g/n power amplifier, a power Detector, and Tx filtering and a Switch, which is capable of switching between WiFi Rx and WiFi Tx operations. The device is manufactured using InGaP HBT and pHEMT processes on a 6mmx6mmx0.95mm Laminate package. The module meets or exceeds the RF front end needs of the 802.11b/g/n WiFi RF systems. As the RF5605 is fully RF matched to 50Ω internally and requires minimal external components, it is very easy to implement on to PCB designs. To reduce the design and optimization process on the customer application, the evaluation board layout should be copied as close as possible, in particular the ground and via configurations. Gerber files of RFMD PCBA designs can be provided upon request. The supply voltage lines should present an RF short to the FEM by using bypass capacitors on the V_{CC} traces. To simplify bias conditions, the RF5605 requires a single positive supply voltage (V_{CC}), a positive current control bias (V_{REG}) supply or high impedance enable, and a positive supply for switch control. The built-in Power Detector of the RF5605 can be used as power monitor in the system. All inputs and outputs are internally matched to 50Ω.

Transmit Path

The RF5605 has a typical gain of 35dB from 2.4GHz to 2.5GHz, and delivers >27dBm typical output power in 11n HT20 MCS7 and >27.5dBm typical in 11g 54Mbps with an EVM <3%. The RF5605 requires a single positive of 5.0V to operate at full specifications. The VREG pin requires a regulated supply at 2.85V to maintain nominal bias current.

Out of Band Rejection

The RF5605 contains a low pass filter (LPF) to attenuate the 2nd Harmonics to -40dBm/MHz (typical). Depending upon the end-user's application, additional filters may be needed to meet the out of band rejection requirements of the system. For the system to meet FCC' s spec, a simple LC can be used between FEM and Antenna, for impedance matching and extra Harmonics attenuation to meet spec.

Receive Path

The Rx path has a 50Ω single-ended port. The Receive port return loss is 9.6dB minimum. In this mode, the FEM has an Insertion loss of 0.8dB and 30dB (typical) isolation to Tx port.

RF5605 Biasing Instructions to the Eval board:

- 802.11b/g/n Transmit:
- Connect the FEM to a signal generator at the input and a spectrum analyzer at the output. Set the Pin at signal generator is at -20dBm.
- Bias V_{CC} to 5.0V first with $V_{REG}=0.0V$. If available, enable the current limiting function of the power supply to 1100mA.
- Refer to switch operational truth table to set the control lines at the proper levels for WiFi Tx. It is recommended to maintain at least 2.85V on VTx during Tx mode. A lower VTx voltage will enable the switch in Tx mode, but 2.85V is needed to ensure that the switch stays in Tx mode during high power peaks. Using a VTx voltage less than 2.85V in Tx mode could result in abnormal operation or device damage.
- Turn on V_{REG} to 2.85V (typ.).
- On VREG (of Eval board), regulated supply is recommended. Be extremely careful not to exceed 3.0V on the VREG pin or the part may exceed device current limits.
- Turn on P_{DOWN} to 2.85V (typ.). P_{DOWN} Pin can be tied to V_{REG} supply.

NOTE: It is important to adjust the V_{CC} voltage source so that +5V is measured at the board; and the +2.85V of V_{REG} is measured at the board. The high collector currents will drop the collector voltage significantly if long leads are used. Adjust the bias voltage to compensate.

- Turn on RF of signal generator and gradually increase power level to the rated power.
CAUTION: If the input signal exceeds the maximum rated power, the RF5605 Evaluation Board can be permanently damaged.
- To turn off FEM, turn off RF power of signal generator; then P_{DOWN} , V_{REG} and V_{CC} .

- 802.11b/g/n Receive
- To receive WiFi set the switch control lines per the truth table.

General Layout Guidelines and considerations:

For best performance the following layout guidelines and considerations must be followed regardless of final use or configuration:

1. The ground pad of the RF5605 has special electrical and thermal grounding requirements. This pad is the main RF ground and main thermal conduct path for heat dissipation. The GND pad and vias pattern and size used on the RFMD evaluation board should be replicated. The RFMD layout files in Gerber format can be provided upon request. Ground paths (under device) should be made as short as possible.
2. The RF lines should be well separated with solid ground in between the traces to eliminate any possible RF leakages or cross-talking.
3. Bypass capacitors should be used on the DC supply lines. The V_{CC} lines may be connected after the RF bypass and decoupling capacitors to provide better isolation between each V_{CC} line.

RF5605 Tx production and system calibration recommendation:

It is highly recommended to follow the DC biasing step and RF power settings in the production calibration or test.

1. Connect the RF cables of input and output then connect to the proper equipment.
2. Apply V_{CC} , then V_{REG} as per the data sheet recommendations.
3. Set FEM in Tx mode by the truth table.
4. Apply P_{DOWN} = high.
5. Set RF input to the desired frequency and initial RF input power at -20dBm. This will insure the Power amplifier is in a linear state and not over driven.
6. Sweep RF from low to high output power and take measurements at the rated output power.
7. Insure that the output power at turn on doesn't saturate the power amplifier. The recommended output power should be about 10dB to 20dB below the nominal input power. Start calibrating from low to high power in reasonable steps until the rated power is reached then take the measurements.

CAUTION: If the input signal exceeds the maximum rated input power specifications, the RF5605 could be permanently damaged.

Package Drawing

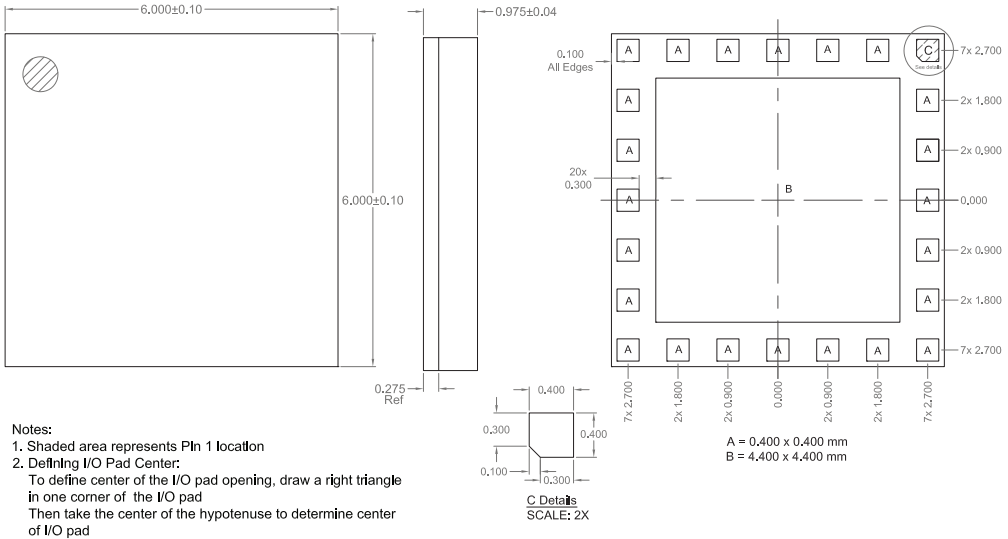

- Notes:**
1. Shaded area represents Pin 1 location
 2. Defining I/O Pad Center:
To define center of the I/O pad opening, draw a right triangle in one corner of the I/O pad. Then take the center of the hypotenuse to determine center of I/O pad

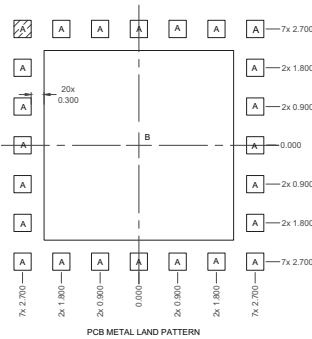

A = 0.400 x 0.400 mm
B = 4.400 x 4.400 mm

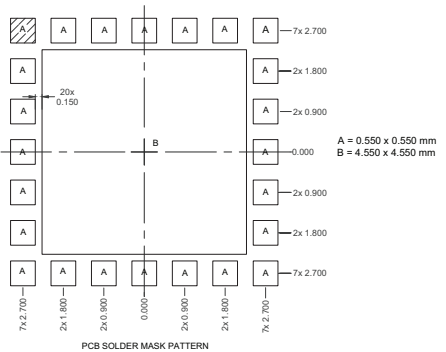

A = 0.550 x 0.550 mm
B = 4.550 x 4.550 mm

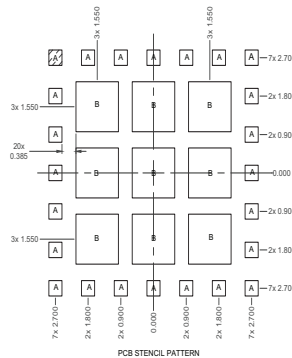

A = 0.360 x 0.360 mm
B = 1.170 x 1.170 mm

Figure 1. Shaded area represents Pin 1 location

NOTE: Thermal vias for center slug “B” should be incorporated into the PCB design. The number and size of thermal vias will depend on the application. Example of the number and size of vias can be found on the RFMD evaluation board layout.

Pin Out

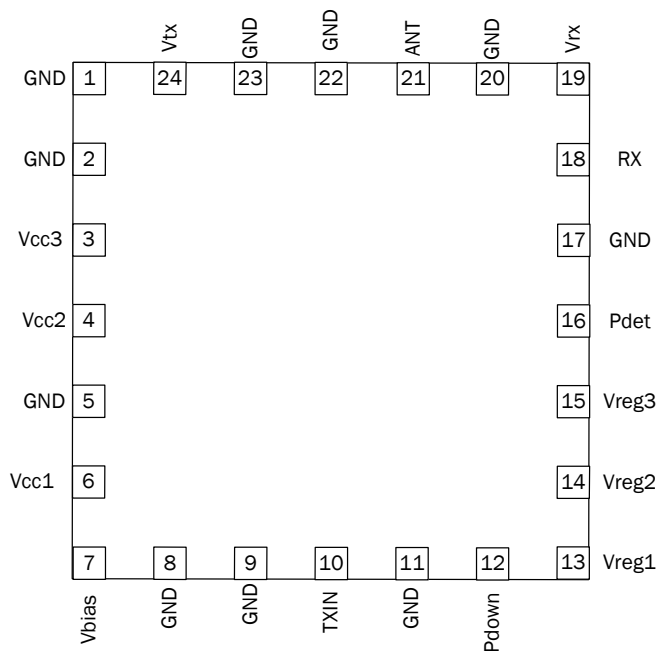

RF5605 Evaluation Board Top Layer

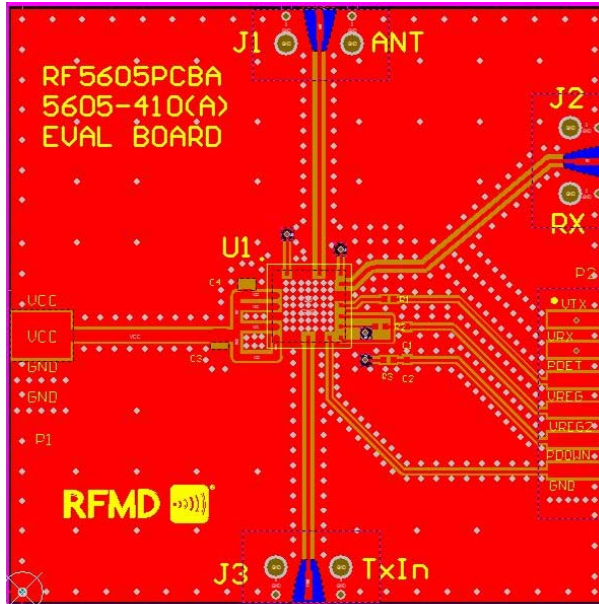

RF5605 Evaluation Board Bottom Layer

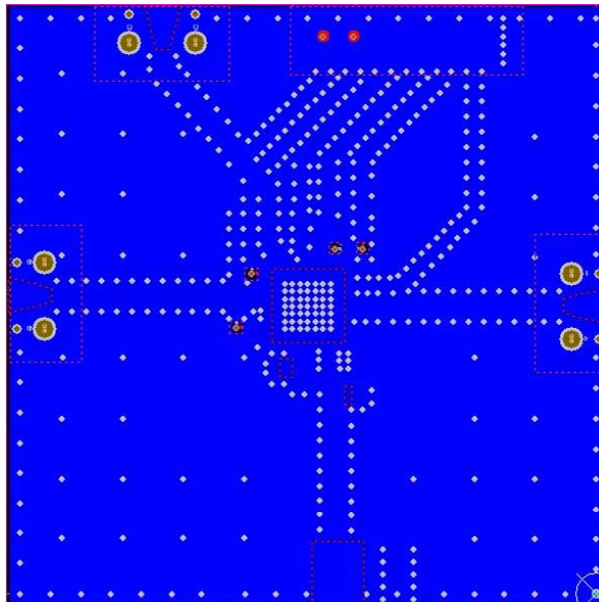

Evaluation Board Schematic

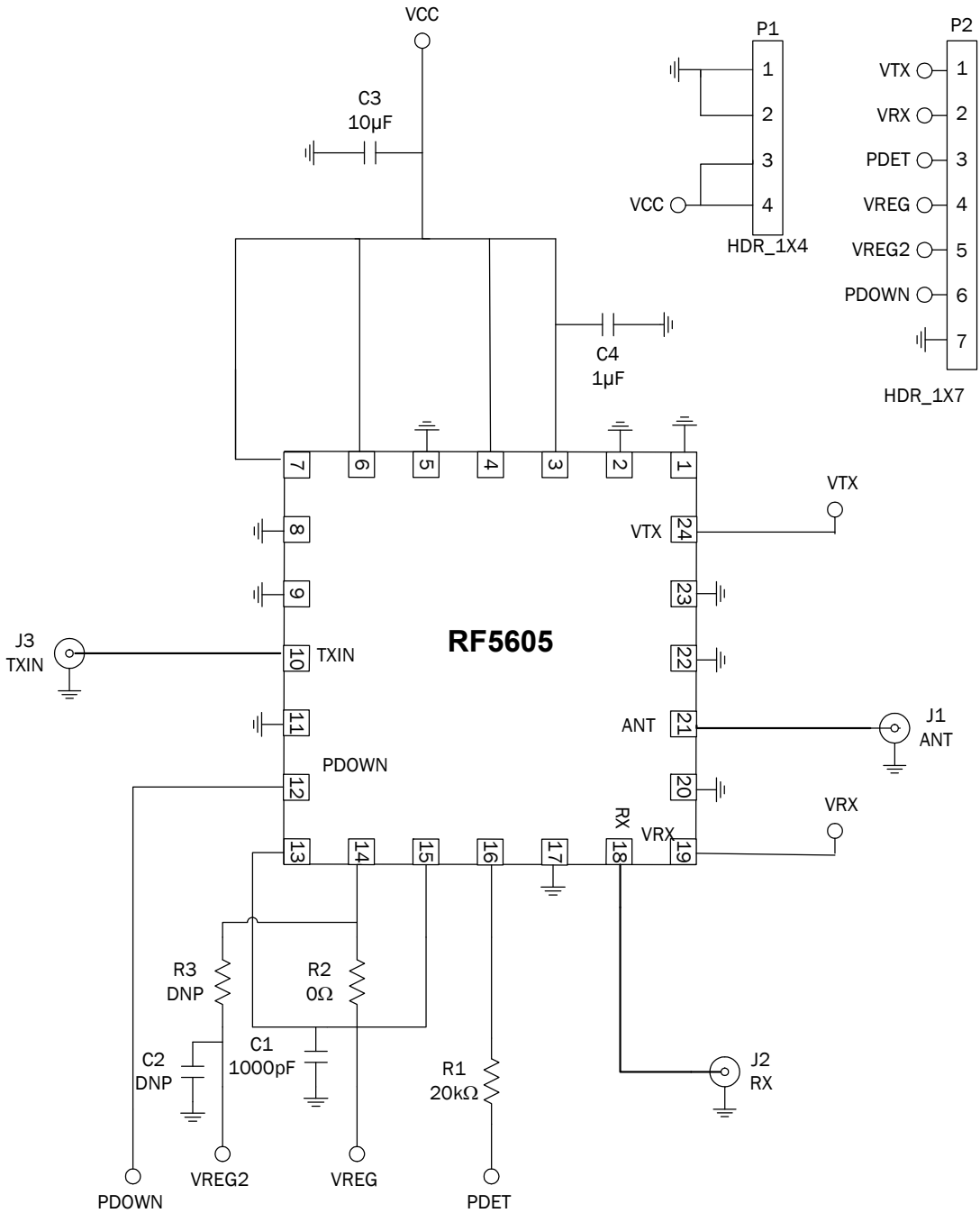

Bill of Material (BOM)

Reference Designator	Description	Qty	Manufacturer	Manufacturer's P/N
C1	CAP, 1000pF, 10%, 50V, X7R, 0402	1	Murata Electronics	GRM155R71H102KA01D
C4	CAP, 1μF, 10%, 10V, X5R, 0402	1	Murata Electronics	GRM155R61A105KE15D
C3	CAP, 10μF, 10%, 10V, X5R, 0805	1	Murata Electronics	RM21BR61A106KE19L
J1, J2, J3	CONN, SMA, END LNCH, UNIV, HYB MNT, FLT	3	MOLEX	SD-73251-4000
R1	RES, 20K, 5%, 1/16W, 0402	1	PANASONIC INDUSTRIAL CO	ERJ-2GEJ203
R2	RES, 0Ω, 0402	1	Kamaya, Inc	RMC1/16SJPTH
R3, C2	DNI			
	PCB, 5605	1		5605-410(A)

WiFi 802.11g Performance Plots in 100% Duty Cycle

EVM(%) versus P_{OUT} (dBm) -40°C
 $V_{CC} = 5VDC$, $V_{REG} = 2.85VDC$, DR = 100% 11g 54Mbps

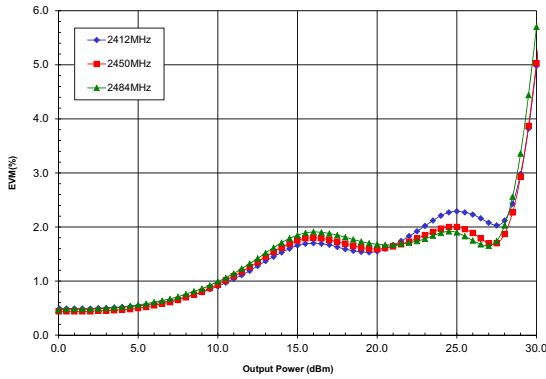

EVM(%) versus P_{OUT} (dBm) 25°C
 $V_{CC} = 5VDC$, $V_{REG} = 2.85VDC$, DR = 100% 11g 54Mbps

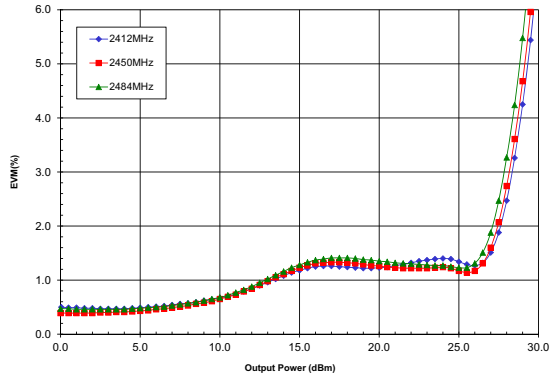

EVM(%) versus P_{OUT} (dBm) 85°C
 $V_{CC} = 5VDC$, $V_{REG} = 2.85VDC$, DR = 100% 11g 54Mbps

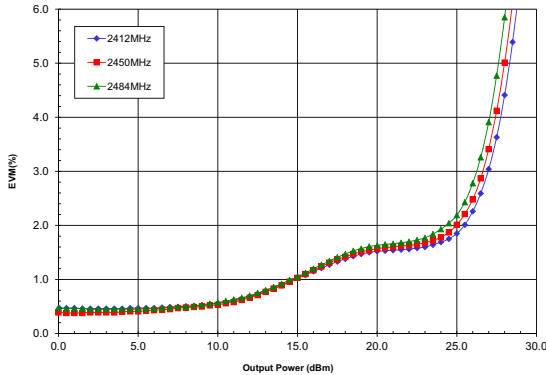

I_{CC} (A) versus P_{OUT} (dBm) -40°C
 $V_{CC} = 5VDC$, $V_{REG} = 2.85VDC$, DR = 100%

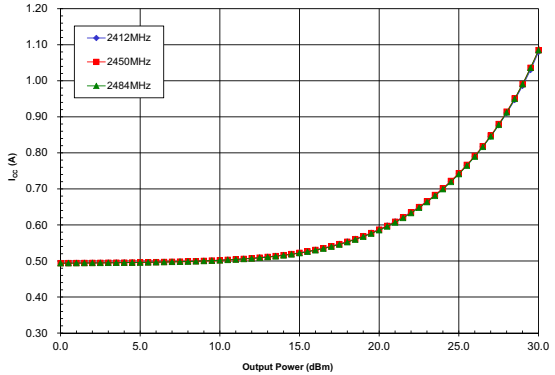

I_{CC} (A) versus P_{OUT} (dBm) 25°C
 $V_{CC} = 5VDC$, $V_{REG} = 2.85VDC$, DR = 100%

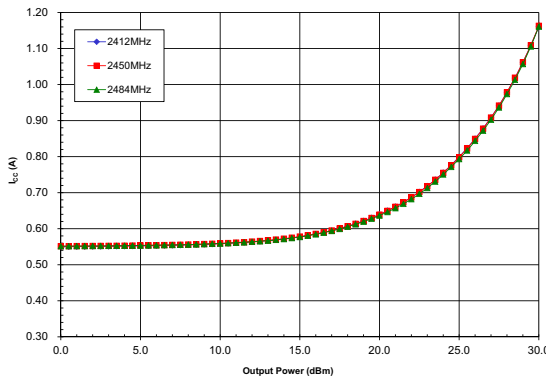

I_{CC} (A) versus P_{OUT} (dBm) 85°C
 $V_{CC} = 5VDC$, $V_{REG} = 2.85VDC$, DR = 100%

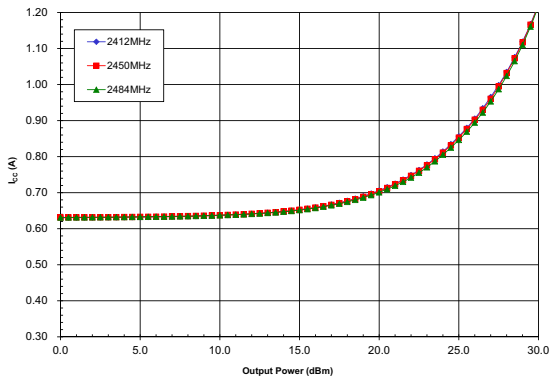

WiFi 802.11g Performance Plots in 100% Duty Cycle (continued)

Gain (dB) versus P_{OUT} (dBm) -40°C
 $V_{CC} = 5VDC$, $V_{REG} = 2.85VDC$, DR = 100%

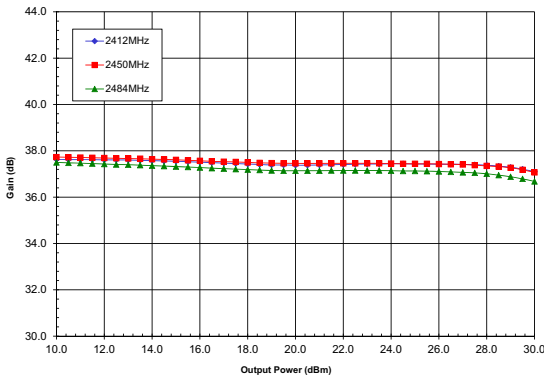

Gain (dB) versus P_{OUT} (dBm) 25°C
 $V_{CC} = 5VDC$, $V_{REG} = 2.85VDC$, DR = 100%

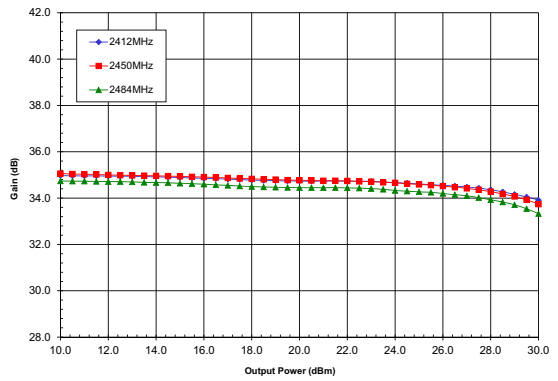

Gain (dB) versus P_{OUT} (dBm) 85°C
 $V_{CC} = 5VDC$, $V_{REG} = 2.85VDC$, DR = 100%

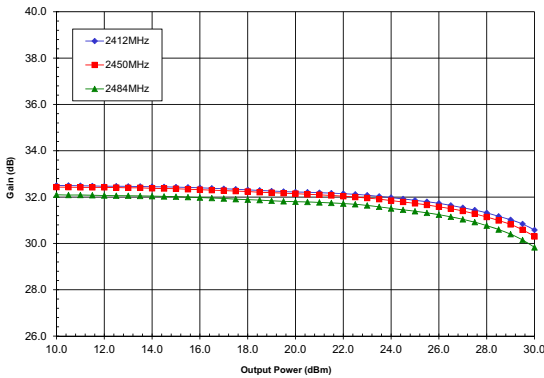

Power Detect (V) versus P_{OUT} (dBm) -40°C
 $V_{CC} = 5VDC$, $V_{REG} = 2.85VDC$, DR = 100%

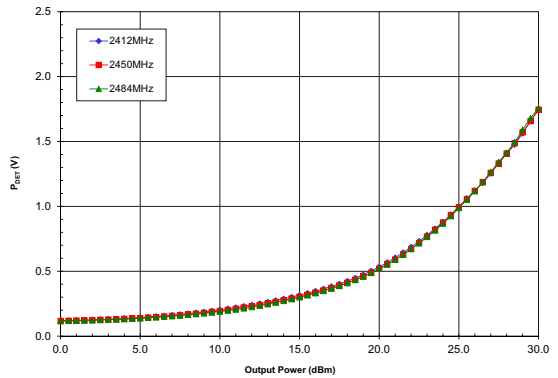

Power Detect (V) versus P_{OUT} (dBm) 25°C
 $V_{CC} = 5VDC$, $V_{REG} = 2.85VDC$, DR = 100%

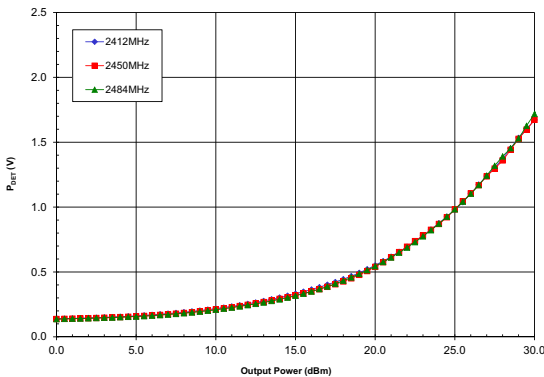

Power Detect (V) versus P_{OUT} (dBm) 85°C
 $V_{CC} = 5VDC$, $V_{REG} = 2.85VDC$, DR = 100%

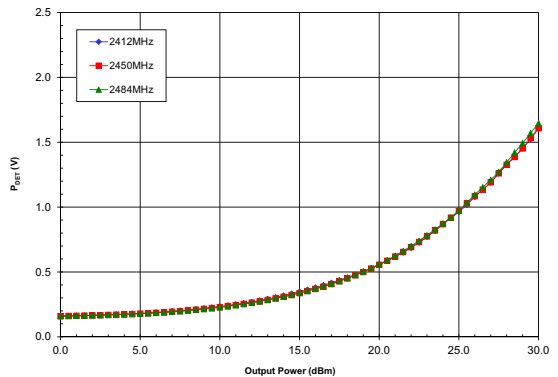

WiFi 802.11n (HT20) Performance Plots in 100% Duty Cycle

EVM(%) versus P_{OUT} (dBm) -40°C
 $V_{CC} = 5VDC$, $V_{REG} = 2.85VDC$, DR = 100% 11n HT20 MCS7

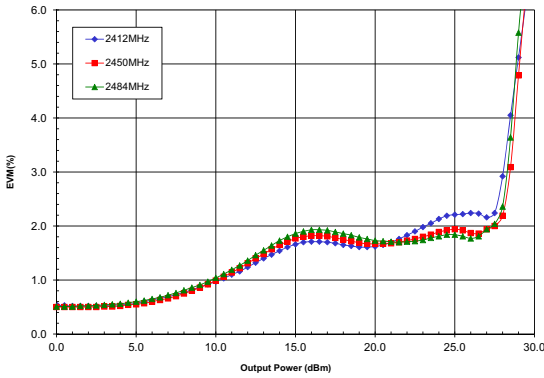

EVM(%) versus P_{OUT} (dBm) 25°C
 $V_{CC} = 5VDC$, $V_{REG} = 2.85VDC$, DR = 100% 11n HT20 MCS7

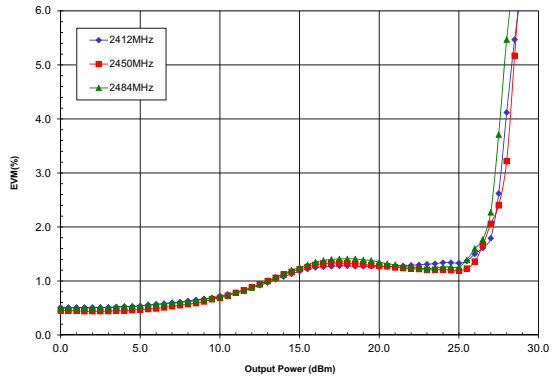

EVM(%) versus P_{OUT} (dBm) 85°C
 $V_{CC} = 5VDC$, $V_{REG} = 2.85VDC$, DR = 100% 11n HT20 MCS7

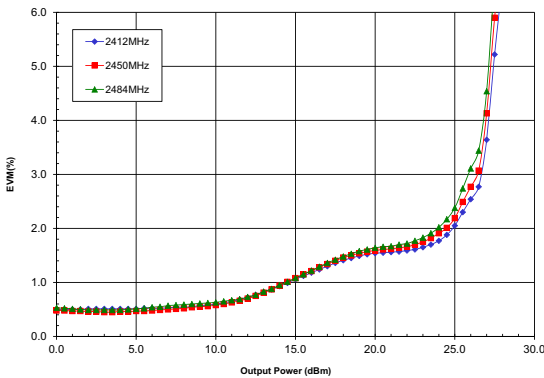

I_{CC} (A) versus P_{OUT} (dBm) -40°C
 $V_{CC} = 5VDC$, $V_{REG} = 2.85VDC$, DR = 100%

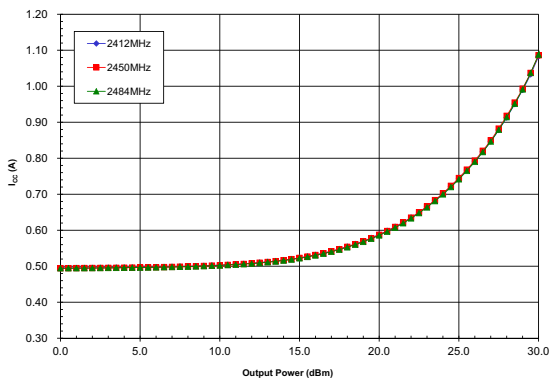

I_{CC} (A) versus P_{OUT} (dBm) 25°C
 $V_{CC} = 5VDC$, $V_{REG} = 2.85VDC$, DR = 100%

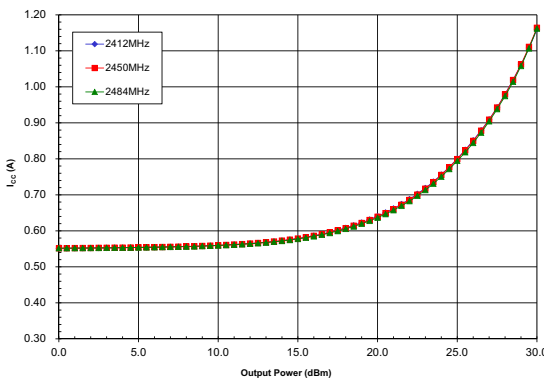

I_{CC} (A) versus P_{OUT} (dBm) 85°C
 $V_{CC} = 5VDC$, $V_{REG} = 2.85VDC$, DR = 100%

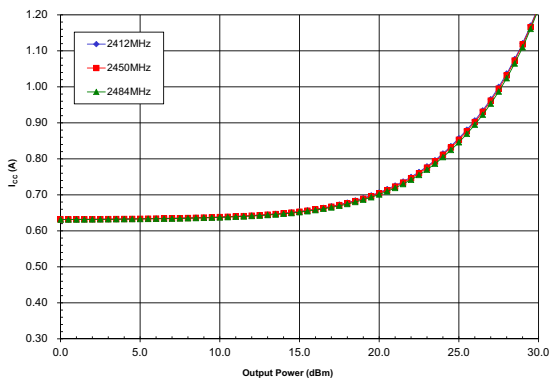

WiFi 802.11n (HT20) Performance Plots in 100% Duty Cycle (continued)

Gain (dB) versus P_{OUT} (dBm) -40°C
 $V_{CC} = 5VDC, V_{REG} = 2.85VDC, DR = 100\%$

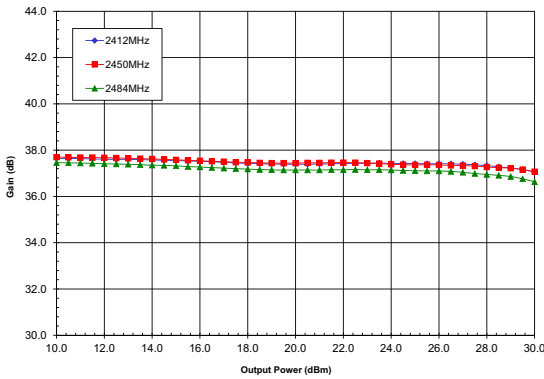

Gain (dB) versus P_{OUT} (dBm) 25°C
 $V_{CC} = 5VDC, V_{REG} = 2.85VDC, DR = 100\%$

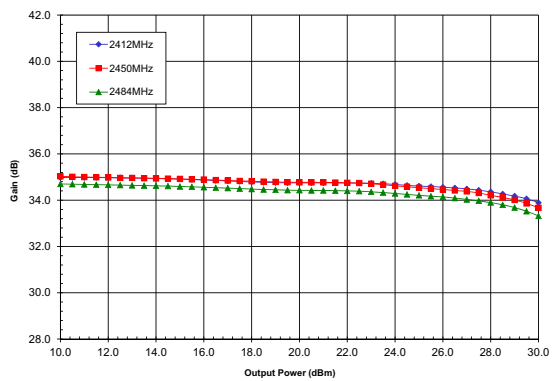

Gain (dB) versus P_{OUT} (dBm) 85°C
 $V_{CC} = 5VDC, V_{REG} = 2.85VDC, DR = 100\%$

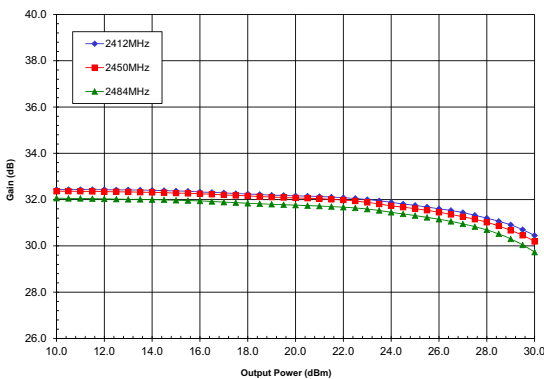

Power Detect (V) versus P_{OUT} (dBm) -40°C
 $V_{CC} = 5VDC, V_{REG} = 2.85VDC, DR = 100\%$

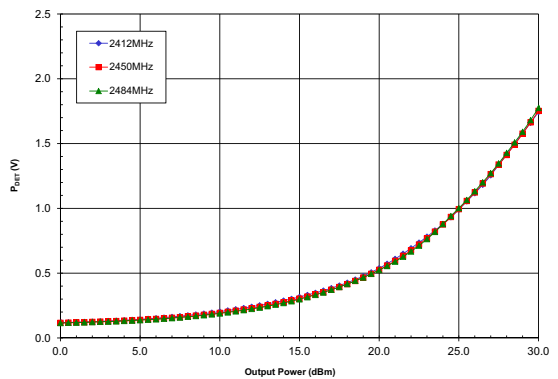

Power Detect (V) versus P_{OUT} (dBm) 25°C
 $V_{CC} = 5VDC, V_{REG} = 2.85VDC, DR = 100\%$

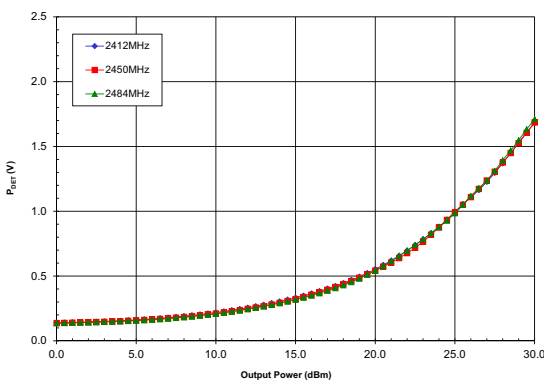

Power Detect (V) versus P_{OUT} (dBm) 85°C
 $V_{CC} = 5VDC, V_{REG} = 2.85VDC, DR = 100\%$

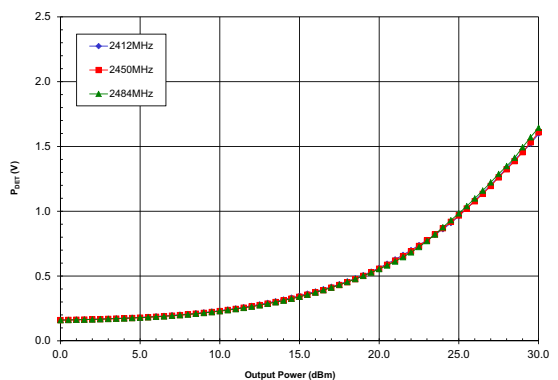

WiFi 802.11n (HT20) Performance Plots in 50% Duty Cycle

EVM(%) versus P_{OUT} (dBm) -40°C
 $V_{CC} = 5VDC$, $V_{REG} = 2.85VDC$, DR = 50% 11n HT20 MCS7

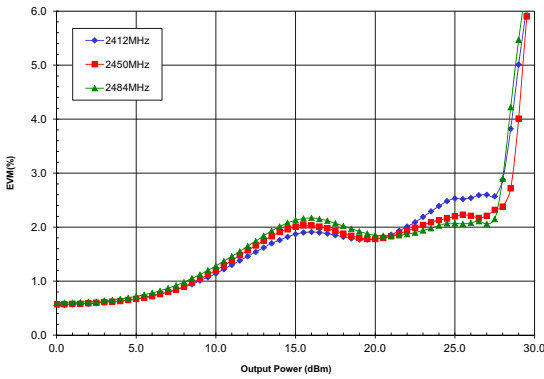

EVM(%) versus P_{OUT} (dBm) 25°C
 $V_{CC} = 5VDC$, $V_{REG} = 2.85VDC$, DR = 50% 11n HT20 MCS7

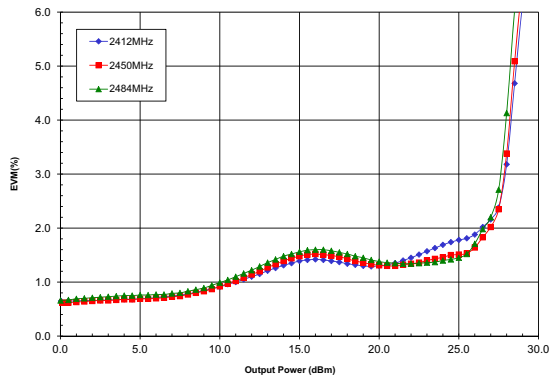

EVM(%) versus P_{OUT} (dBm) 85°C
 $V_{CC} = 5VDC$, $V_{REG} = 2.85VDC$, DR = 50% 11n HT20 MCS7

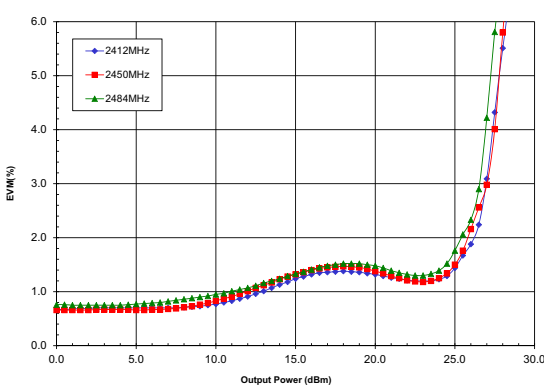

I_{CC} (A) versus P_{OUT} (dBm) -40°C
 $V_{CC} = 5VDC$, $V_{REG} = 2.85VDC$, DR = 50%

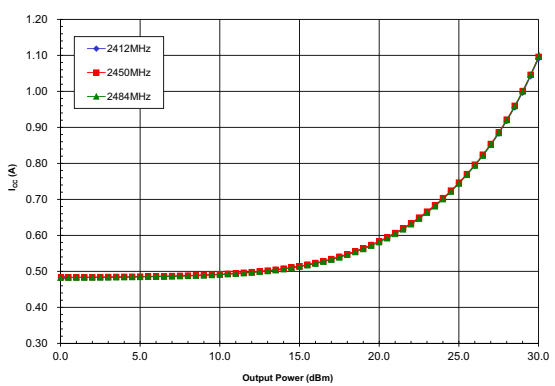

I_{CC} (A) versus P_{OUT} (dBm) 25°C
 $V_{CC} = 5VDC$, $V_{REG} = 2.85VDC$, DR = 50%

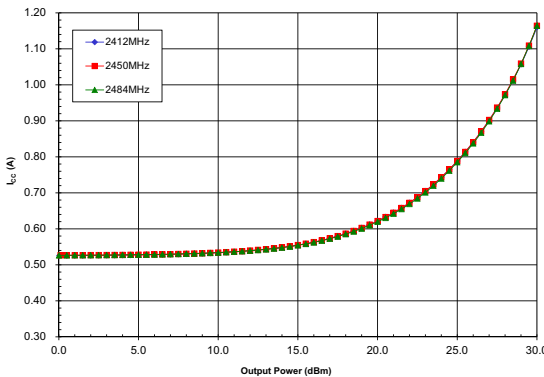

I_{CC} (A) versus P_{OUT} (dBm) 85°C
 $V_{CC} = 5VDC$, $V_{REG} = 2.85VDC$, DR = 50%

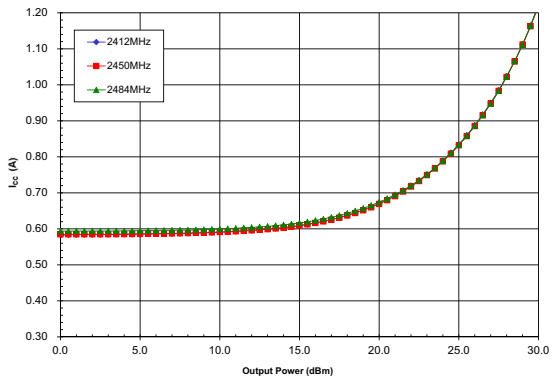

WiFi 802.11n (HT20) Performance Plots in 50% Duty Cycle (continued)

Gain(dB) versus P_{OUT} (dBm) -40°C
 $V_{CC} = 5VDC$, $V_{REG} = 2.85VDC$, DR = 50%

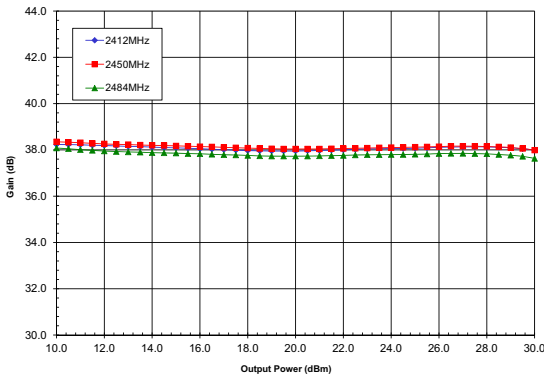

Gain(dB) versus P_{OUT} (dBm) 25°C
 $V_{CC} = 5VDC$, $V_{REG} = 2.85VDC$, DR = 50%

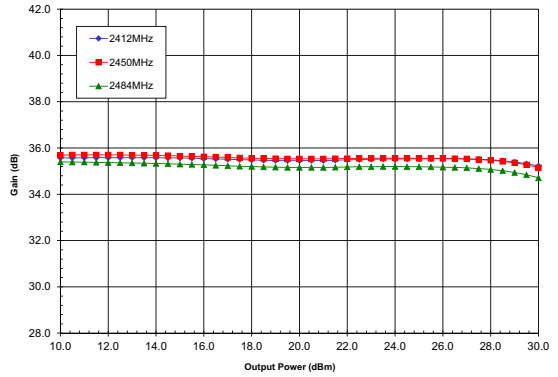

Gain(dB) versus P_{OUT} (dBm) 85°C
 $V_{CC} = 5VDC$, $V_{REG} = 2.85VDC$, DR = 50%

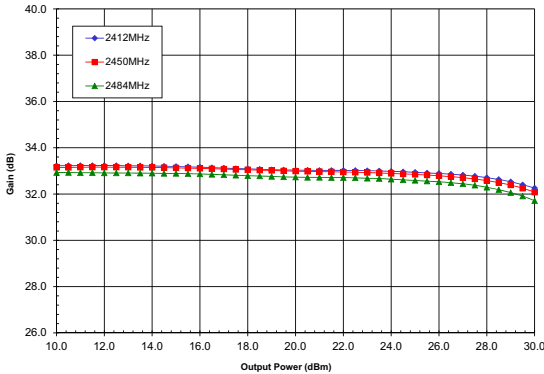

Power Detect (V) versus P_{OUT} (dBm) -40°C
 $V_{CC} = 5VDC$, $V_{REG} = 2.85VDC$, DR = 50%

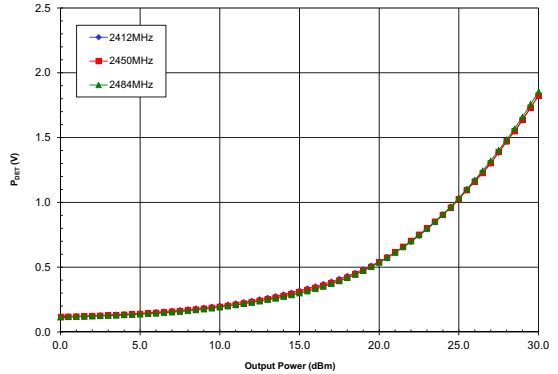

Power Detect (V) versus P_{OUT} (dBm) 25°C
 $V_{CC} = 5VDC$, $V_{REG} = 2.85VDC$, DR = 50%

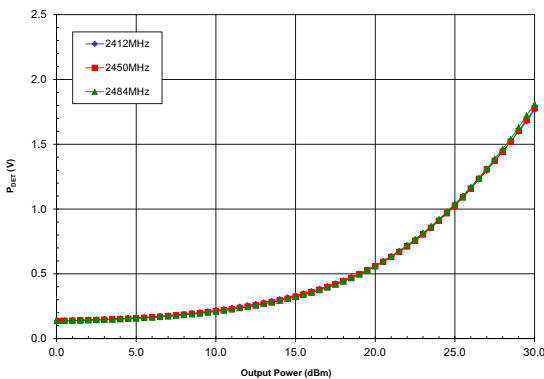

Power Detect (V) versus P_{OUT} (dBm) 85°C
 $V_{CC} = 5VDC$, $V_{REG} = 2.85VDC$, DR = 50%

