



Package Style: QFN, 16-Pin, 0.9mm x 3mm x 3mm



Features

- Patent Pending Circuit Architecture
- Broadband 50MHz to 3000MHz Frequency Range
- 30dB Attenuation Range
- +50dBm IIP3 Typical
- +80dBm IIP2 Typical
- Low Distortion -65dBc CSO and -70dBc CTB for 112 Channel 39dBmV Input
- High 1dB Compression Point >+30dBm
- Low Supply Current 1mA Typical
- 5V Power Supply
- Linear in dB Control Characteristic
- Internal Temperature Compensation
- Class 1C ESD (1000V)
- Complete Solution in a Small 3mm x 3mm, QFN Package
- 3.3V Version Available RFSA3023

Applications

- Cable Modems
- CATV
- High Linearity Power Control

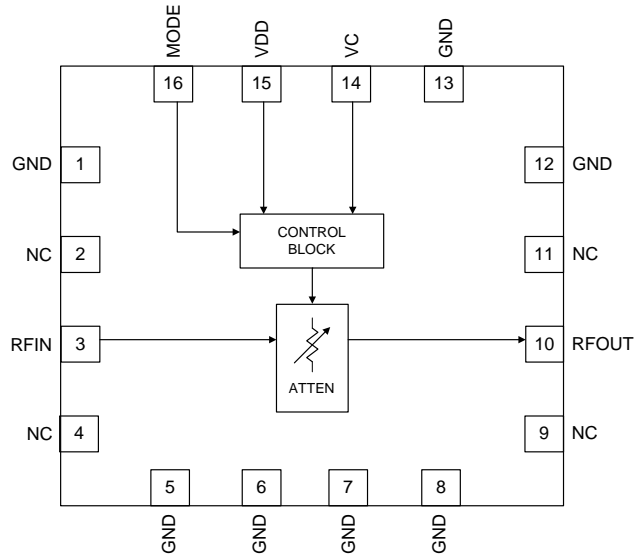

Functional Block Diagram

Product Description

RFMD's RFSA3013 is a fully monolithic analog voltage controlled attenuator (VCA) featuring exceptional linearity over a typical temperature compensated 30dB gain control range. It incorporates a revolutionary new circuit architecture to solve a long standing industry problem: high IP3, high attenuation range, low DC current, broad bandwidth and temperature compensated linear in dB control voltage characteristic. This voltage controlled attenuator is controlled by a single positive control voltage with on-chip DC conditioning circuitry. The slope of the control voltage versus gain is selectable. The RFSA3013 draws a very low 1mA current and is packaged in a small 3mm x 3mm QFN. This attenuator is matched to 75Ω over its rated control range and frequency with no external matching components required. Typical VCAs in this performance category have poor inherent attenuation versus temperature and poor nonlinear attenuation versus control voltage characteristics. To correct these shortcomings, other VCAs require extensive off chip analog support circuitry that consume valuable PCB area and additional DC power. This game changing product incorporates the complete solution in a small 3mm x 3mm QFN package that reduces the footprint by 20X in area and reduces the DC power by 10X over conventional PIN diode approaches.

Ordering Information

RFSA3013SR	7" Sample reel with 100 pieces
RFSA3013SQ	Sample bag with 25 pieces
RFSA3013TR7	7" Reel with 2500 pieces
RFSA3013PCK-410	50MHz to 3000MHz PCBA with 5-piece sample bag

Optimum Technology Matching® Applied

- | | | | |
|--------------------------------------|--------------------------------------|---|------------------------------------|
| <input type="checkbox"/> GaAs HBT | <input type="checkbox"/> SiGe BiCMOS | <input type="checkbox"/> GaAs pHEMT | <input type="checkbox"/> GaN HEMT |
| <input type="checkbox"/> GaAs MESFET | <input type="checkbox"/> Si BiCMOS | <input checked="" type="checkbox"/> Si CMOS | <input type="checkbox"/> BiFET HBT |
| <input type="checkbox"/> InGaP HBT | <input type="checkbox"/> SiGe HBT | <input type="checkbox"/> Si BJT | |

RF MICRO DEVICES®, RFMD®, Optimum Technology Matching®, Enabling Wireless Connectivity™, PowerStar®, POLARIS™ TOTAL RADIO™ and UltimateBlue™ are trademarks of RFMD, LLC. BLUETOOTH is a trademark owned by Bluetooth SIG, Inc., U.S.A. and licensed for use by RFMD. All other trade names, trademarks and registered trademarks are the property of their respective owners. ©2012, RF Micro Devices, Inc.

Absolute Maximum Ratings

Parameter	Rating	Unit
Supply Voltage (V_{DD})	-0.5 to +6	V
Control Voltage (V_C)	-0.5 to +6	V
Mode Pin Voltage (MODE)	-0.5 to +6	V
RF Input Power	+30	dBm
Operating Temperature (T_{CASE})	-40 to +85	°C
Storage Temperature	-65 to +150	°C
Junction Temperature (T_J)	+125	°C
ESD Rating – Human Body Model (HBM)	1000	V



Caution! ESD sensitive device.

Exceeding any one or a combination of the Absolute Maximum Rating conditions may cause permanent damage to the device. Extended application of Absolute Maximum Rating conditions to the device may reduce device reliability. Specified typical performance or functional operation of the device under Absolute Maximum Rating conditions is not implied.

The information in this publication is believed to be accurate and reliable. However, no responsibility is assumed by RF Micro Devices, Inc. ("RFMD") for its use, nor for any infringement of patents, or other rights of third parties, resulting from its use. No license is granted by implication or otherwise under any patent or patent rights of RFMD. RFMD reserves the right to change component circuitry, recommended application circuitry and specifications at any time without prior notice.



RFMD Green: RoHS compliant per EU Directive 2002/95/EC, halogen free per IEC 61249-2-21, < 1000ppm each of antimony trioxide in polymeric materials and red phosphorus as a flame retardant, and <2% antimony in solder.

Parameter	Specification			Unit	Condition
	Min.	Typ.	Max.		
General					
Supply Voltage	4.75	5	5.25	V	
Supply Current		1		mA	
Operating Temperature	-40		85	°C	
Thermal Resistance		45		°C/W	RF input must be RFIN pin
RF Input Power			27	dBm	RF input must be RFIN pin
RF Performance					
Frequency Range	50		3000	MHz	
Minimum Insertion Loss		2.5	3.5	dB	
Gain Control Range	30	35		dB	
Gain versus Temperature		1.5		dB	Peak to peak gain variation over temperature for fixed control voltage
Return Loss		10		dB	
Relative Phase		11		Deg	Insertion phase at 15dB attenuation relative to minimum attenuation
Input 1dB Compression Point		30		dBm	
Input IP3	42	50		dBm	$P_{IN} + (IM3_{dBc}/2)$
Input IP2		80		dBm	$P_{IN} + IM2_{dBc}$, $IM2$ is $F1+F2$
Input IH2		80		dBm	$P_{IN} + H2_{dBc}$, $H2$ is second harmonic
Input IH3		50		dBm	$P_{IN} + (H3_{dBc}/2)$, $H3$ is third harmonic
Composite Performance					
					$V_{DD} = 5V, V_C = 3.5V, T = +25^\circ C$
CSO		-65		dBc	55.25MHz to 745.25MHz, 112 Channel, +39dBmV input Flat Tilt
CTB		-70		dBc	55.25MHz to 745.25MHz, 112 Channel, +39dBmV input Flat Tilt
XMOD		-60		dBc	55.25MHz to 745.25MHz, 112 Channel, +39dBmV input Flat Tilt
Control					
Voltage Control Range, Positive Attenuation Slope	0.5		4.5	V	4.5V control voltage is lowest insertion loss, MODE pin high
Voltage Control Range, Negative Attenuation Slope	0		3.3	V	0V control voltage is lowest insertion loss, MODE pin low

Note: Typical performance at nominal conditions unless otherwise noted: Supply voltage = 5.0V, Operating temperature = 25°C, RF Frequency 1GHz

Parameter	Specification			Unit	Condition
	Min.	Typ.	Max.		
Control con't					
Voltage Control Pin Current (MODE high)		37		μA	VC Pin at 5V
Voltage Control Pin Current (MODE low)		24		μA	VC Pin at 3.3V
MODE Pin Logic Low			0.4	V	
MODE Pin Logic High	1			V	
Settling Time		15		μsec	1dB attenuation change settling within 0.1dB

Note: Typical performance at nominal conditions unless otherwise noted: Supply voltage = 5.0V, Operating temperature = 25 °C, RF Frequency 1GHz

Measured Positive Attenuation Slope Performance

Note: Data includes PCB and connector losses

Insertion Loss versus Voltage Control
RFSA3013, RF 1GHz, $V_{DD}=5V$

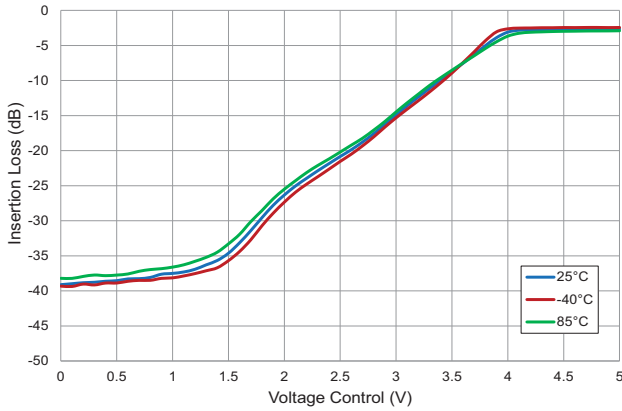

Insertion Loss versus Frequency
RFSA3013, $V_{DD}=5V$, Temp=+25°C

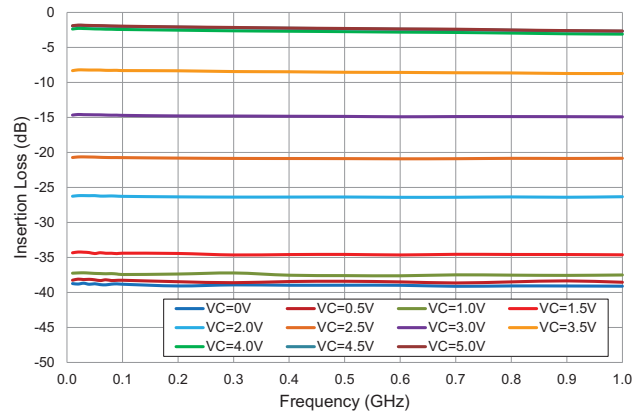

Input Return Loss versus Frequency
RFSA3013, $V_{DD}=5V$, Temp=+25°C

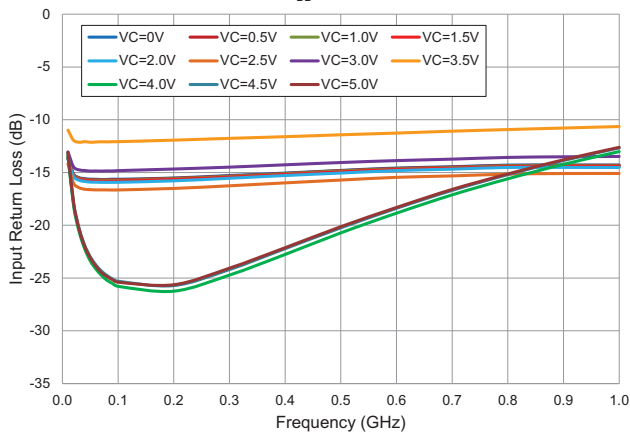

Output Return Loss versus Frequency
RFSA3013, $V_{DD}=5V$, Temp=+25°C

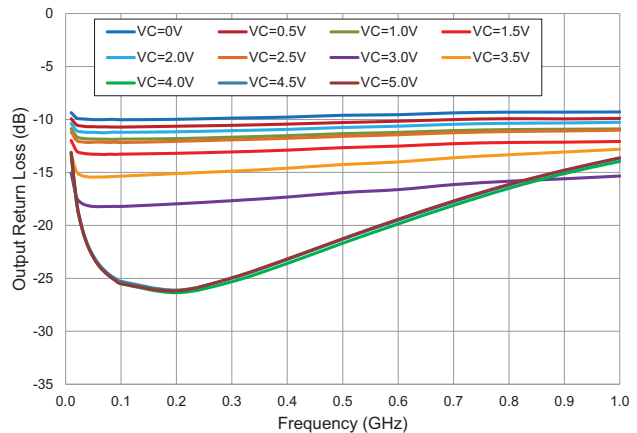

Input Return Loss versus Voltage Control
RFSA3013, RF 1GHz, $V_{DD}=5V$

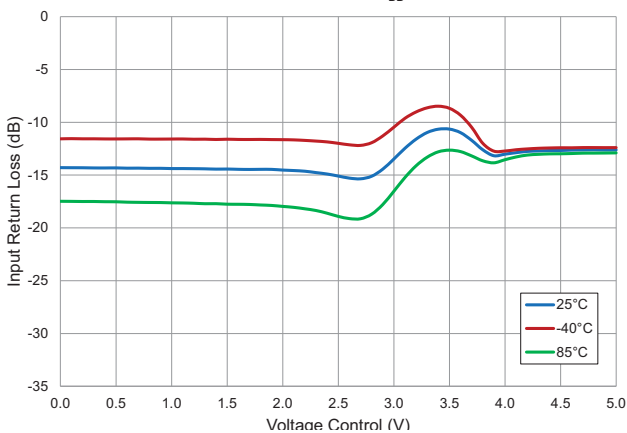

Output Return Loss versus Voltage Control
RFSA3013, RF 1GHz, $V_{DD}=5V$

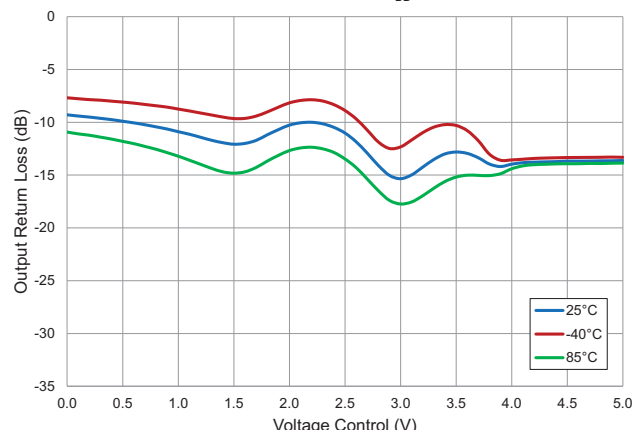

Measured Positive Attenuation Slope Performance

Note: Data includes PCB and connector losses

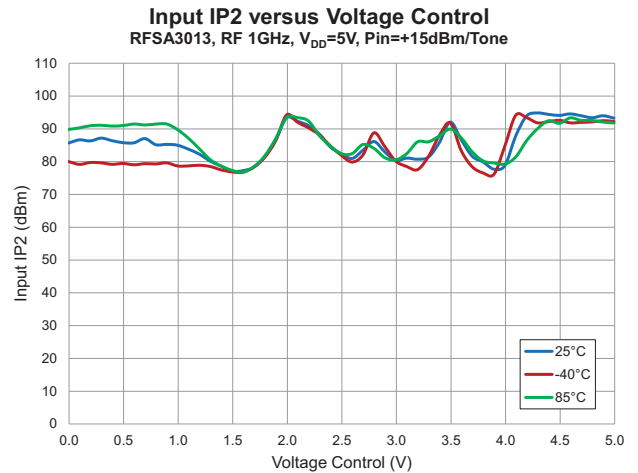
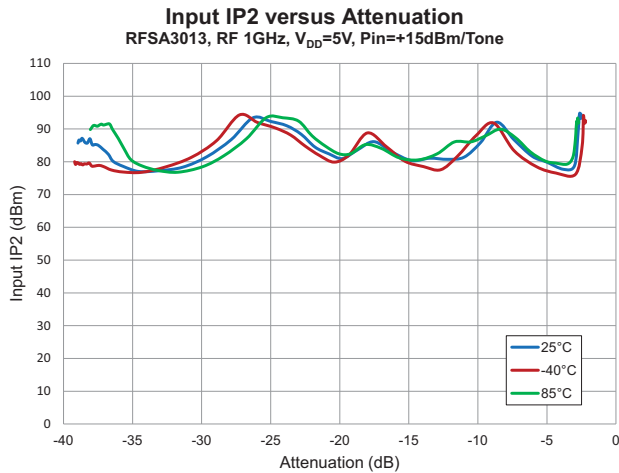
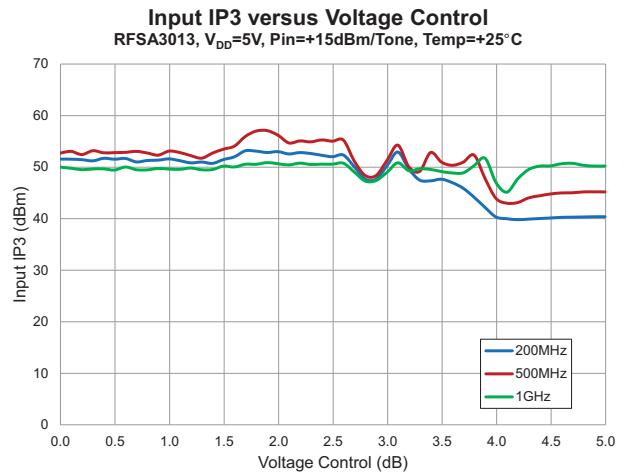
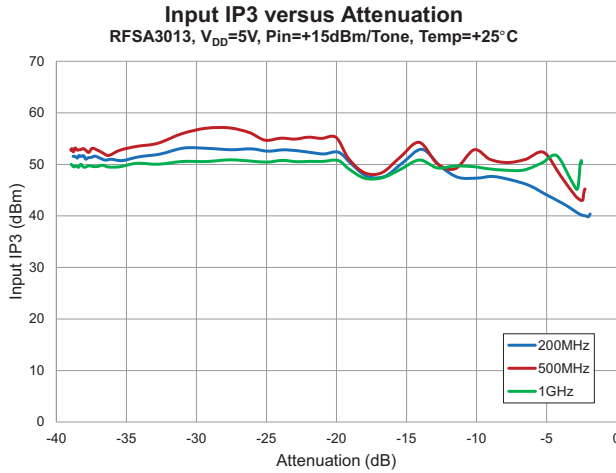
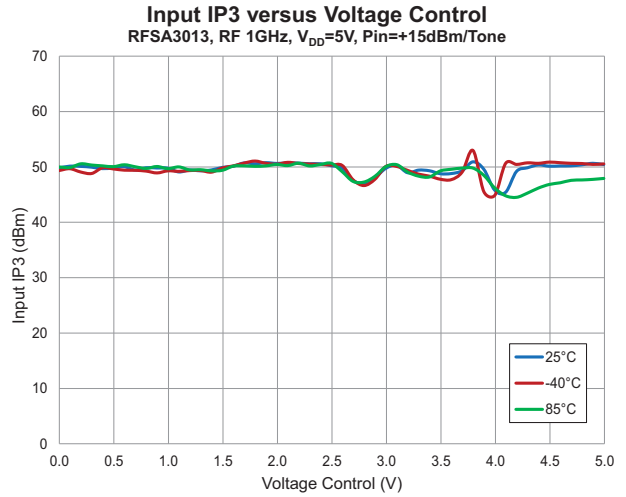
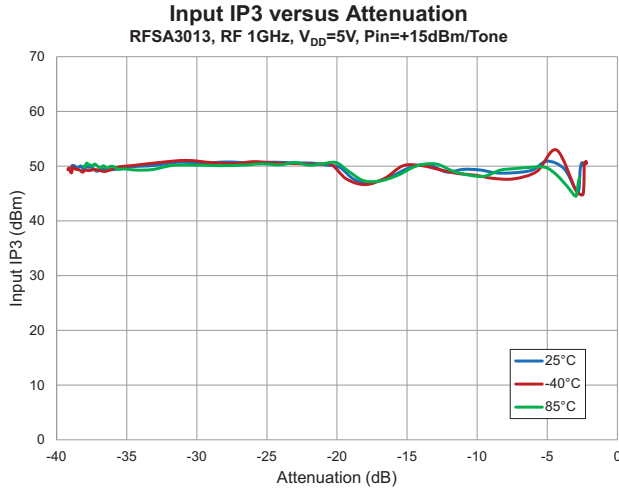

Measured Positive Attenuation Slope Performance

Note: Data includes PCB and connector losses

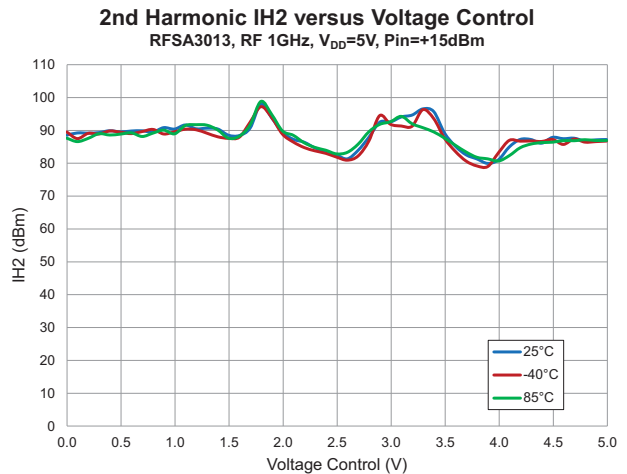
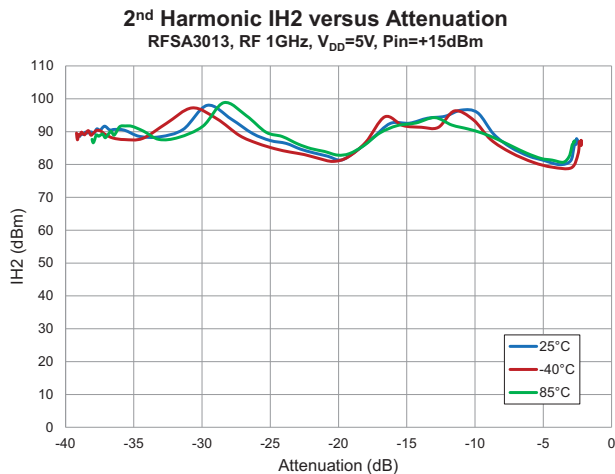
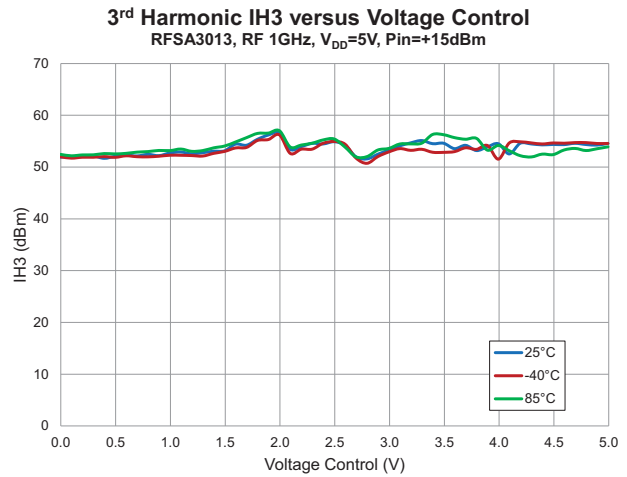
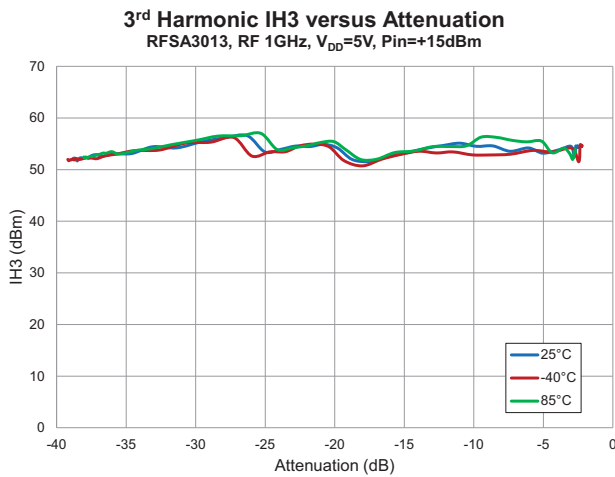
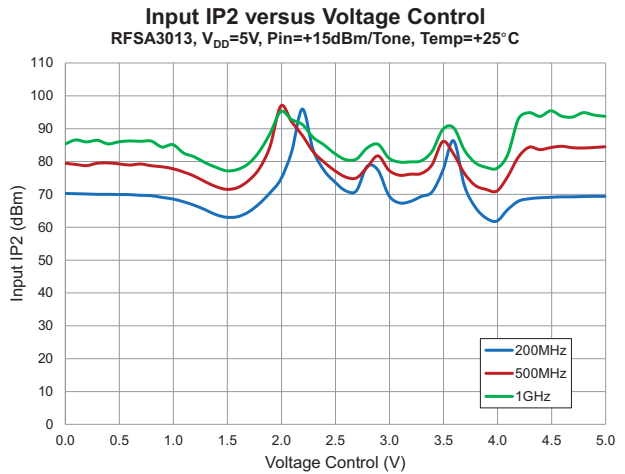
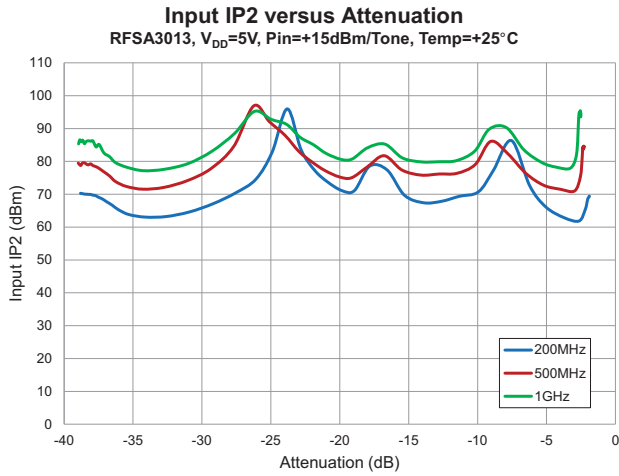

Measured Positive Attenuation Slope Performance

Note: Data includes PCB and connector losses

Relative Insertion Phase versus Voltage Control
RFSA3013, $V_{DD}=5V$, Temp=25°C

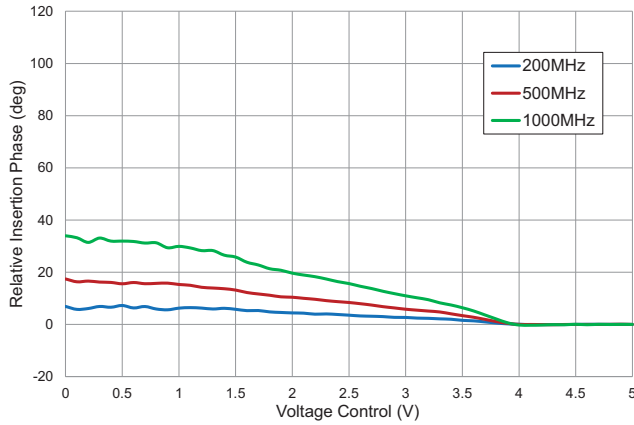

Relative Insertion Phase versus Insertion Loss
VCA 5V Mode, $V_{DD}=5V$, Temp=25°C

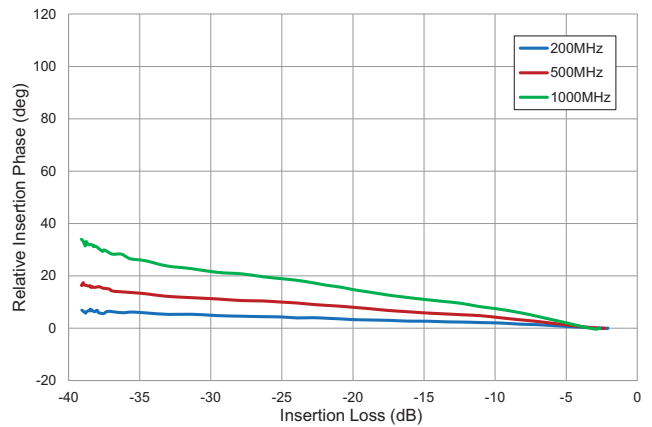

Insertion Loss Relative to +25°C
RFSA3013, RF 1GHz, $V_{DD}=5V$

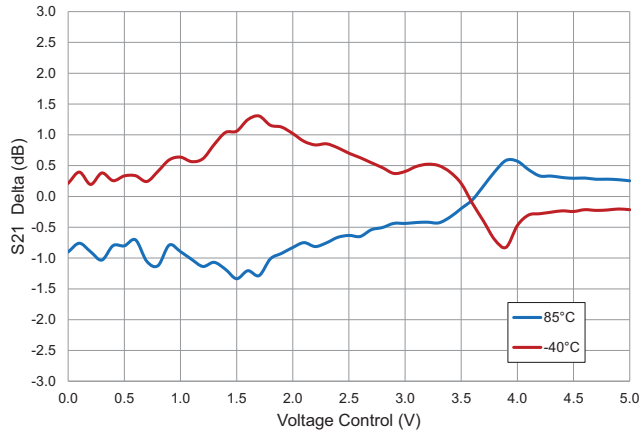

Settling Time versus Insertion Loss
1dB Steps, RF 1GHz, $V_{DD}=5V$

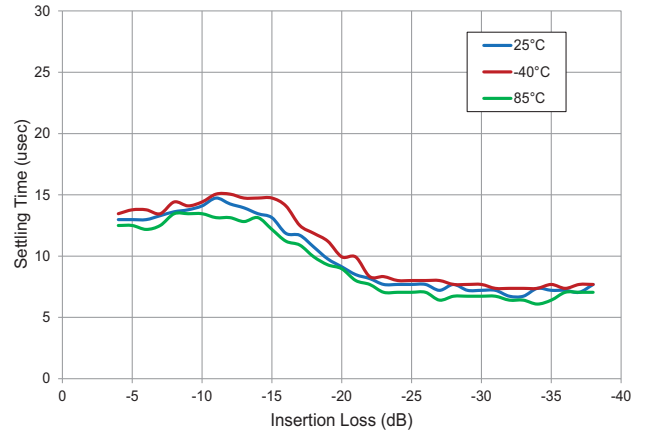

Measured Negative Attenuation Slope Performance

Note: Data includes PCB and connector losses

Insertion Loss versus Voltage Control
RFSA3013, RF 1GHz, $V_{DD}=5V$

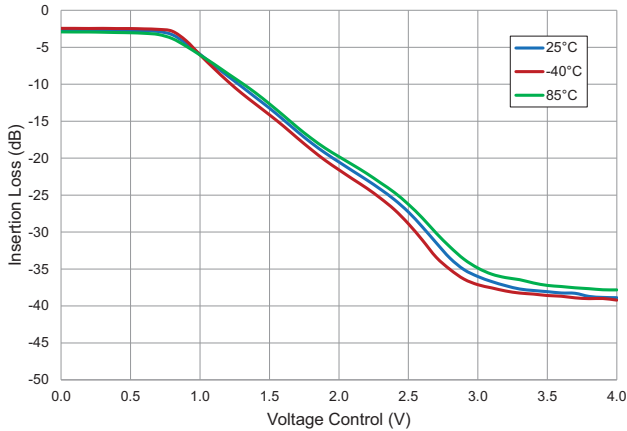

Insertion Loss versus Frequency
RFSA3013, $V_{DD}=5V$, Temp=+25°C

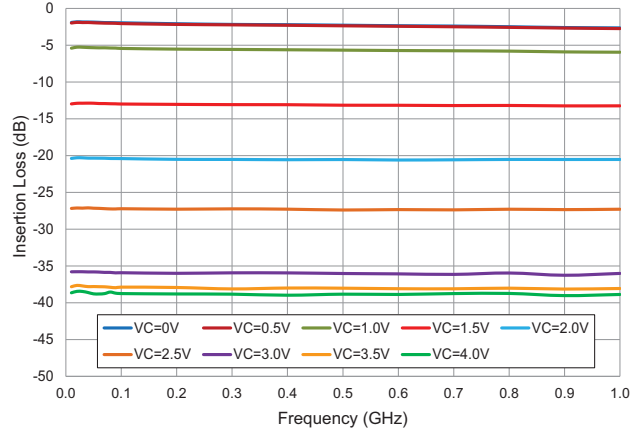

Input Return Loss versus Frequency
RFSA3013, $V_{DD}=5V$, Temp=+25°C

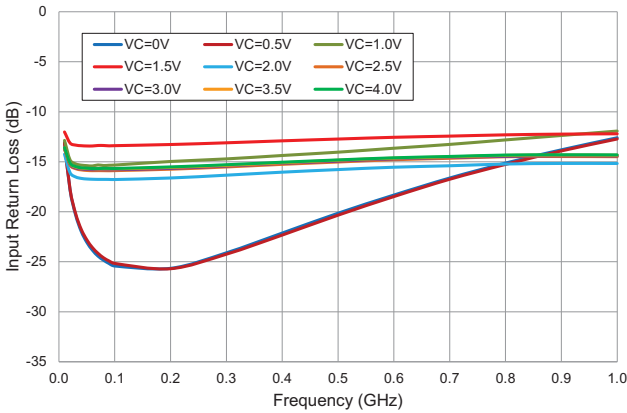

Output Return Loss versus Frequency
RFSA3013, $V_{DD}=5V$, Temp=+25°C

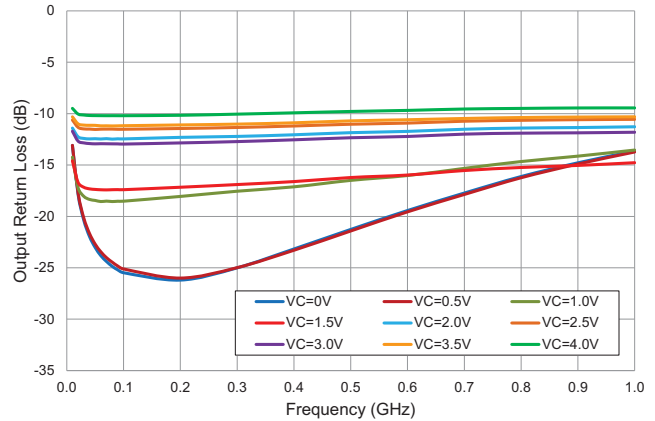

Input Return Loss versus Voltage Control
RFSA3013, RF 1GHz, $V_{DD}=5V$

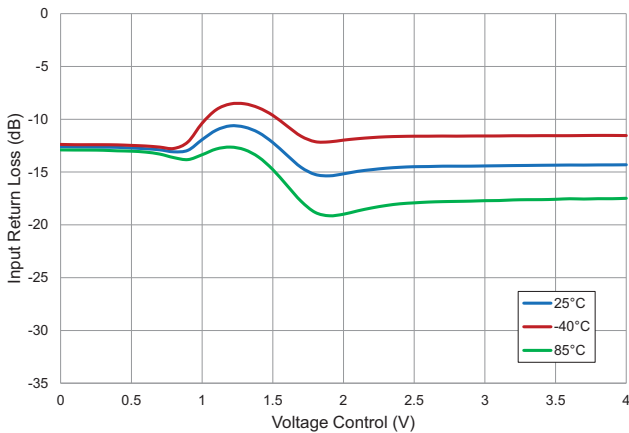

Output Return Loss versus Voltage Control
RFSA3013, RF 1GHz, $V_{DD}=5V$

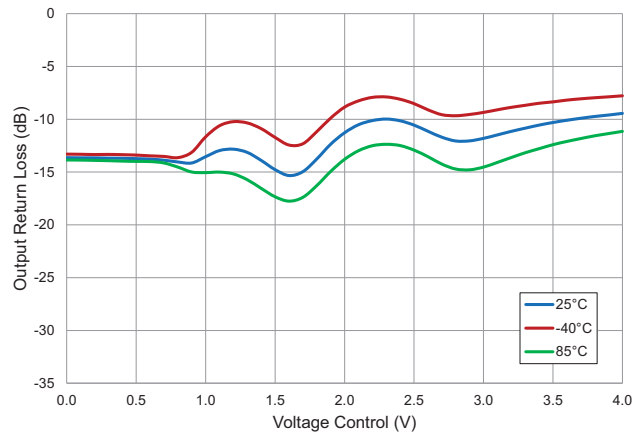

Measured Negative Attenuation Slope Performance

Note: Data includes PCB and connector losses

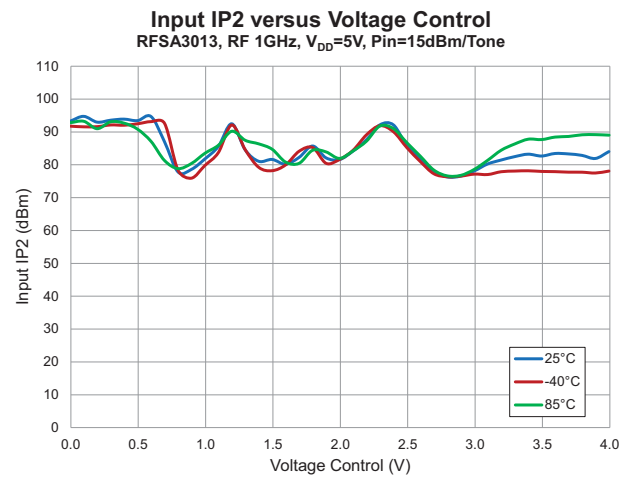
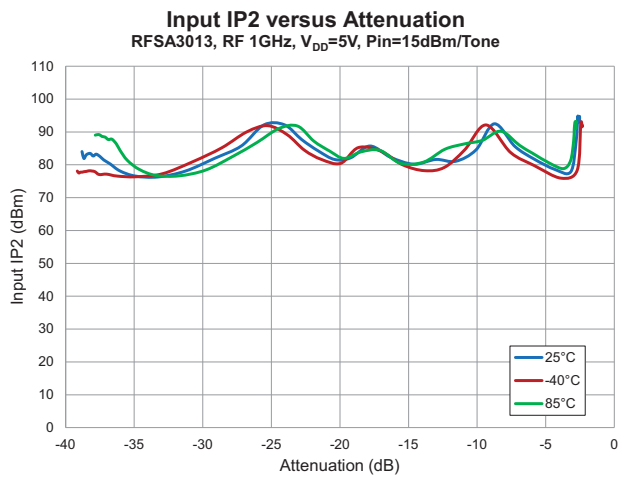
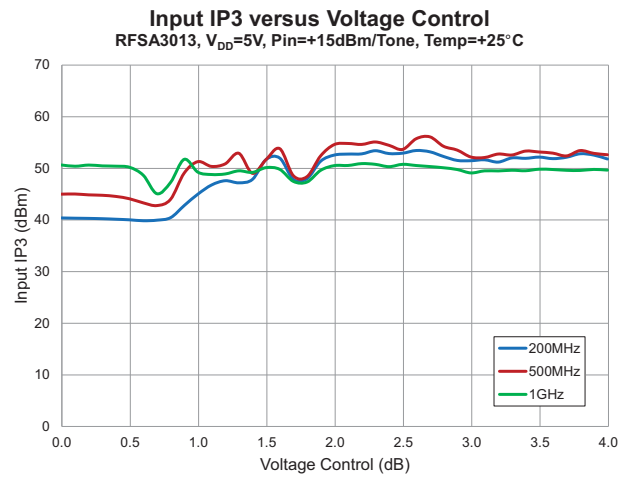
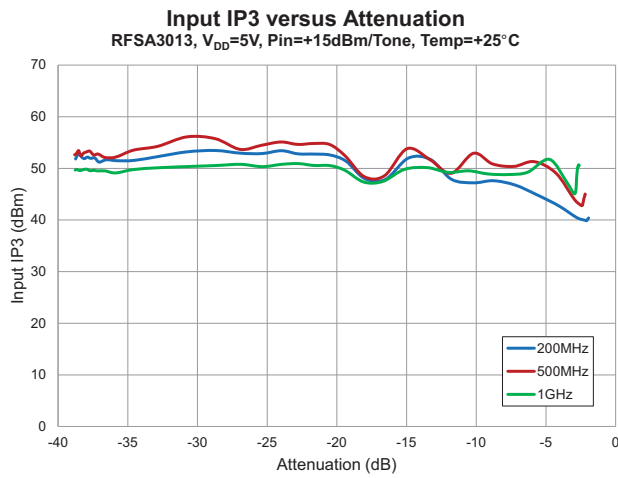
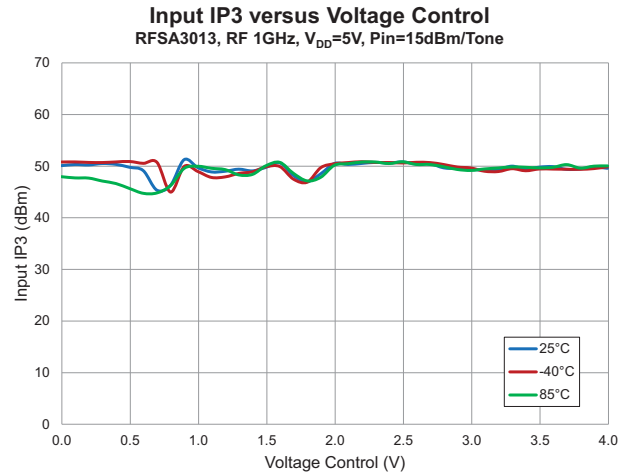
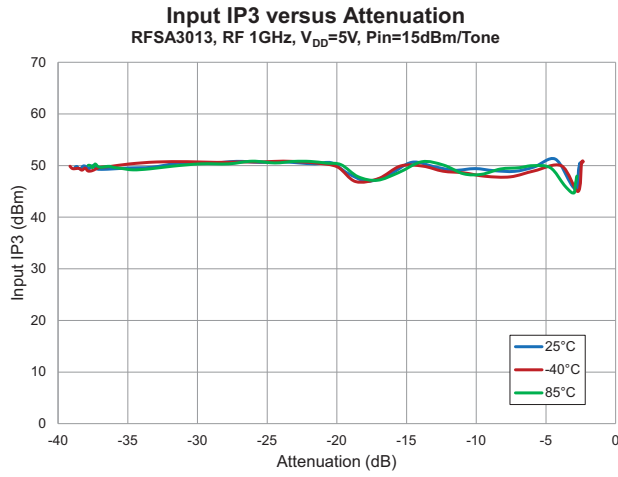

Measured Negative Attenuation Slope Performance

Note: Data includes PCB and connector losses

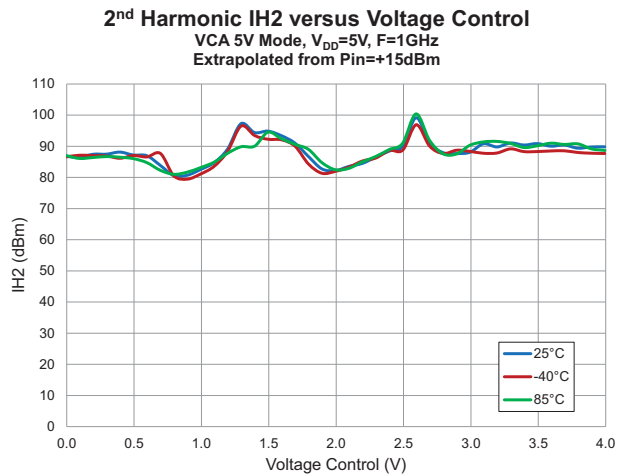
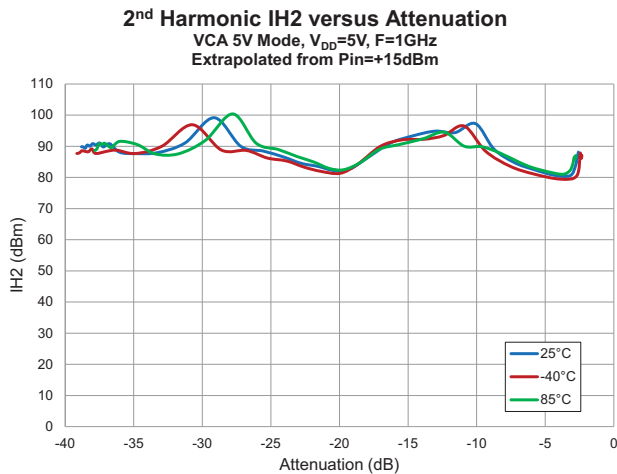
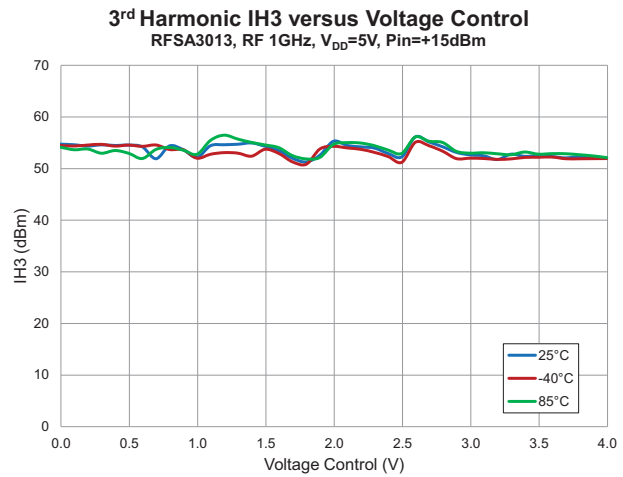
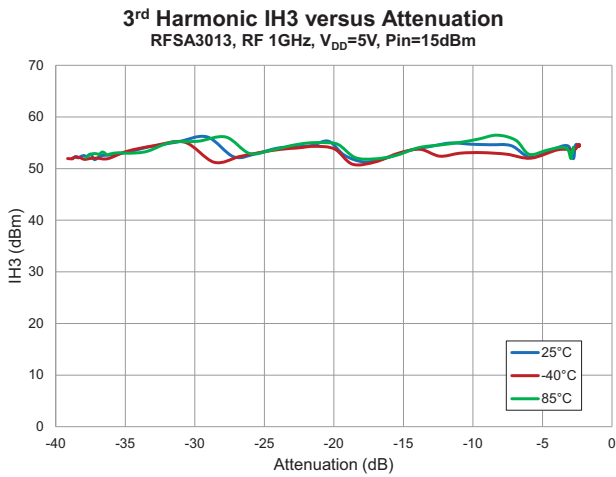
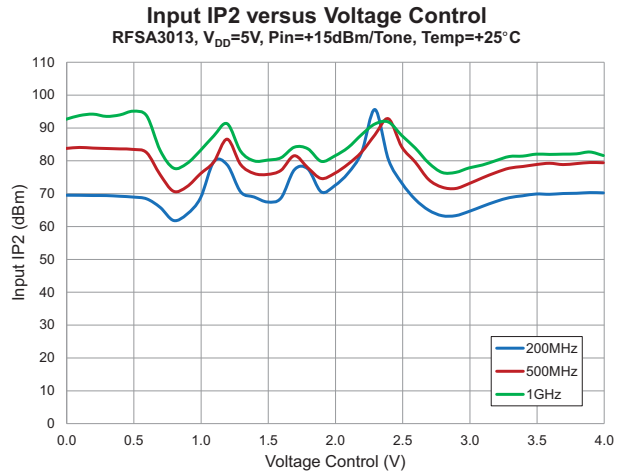
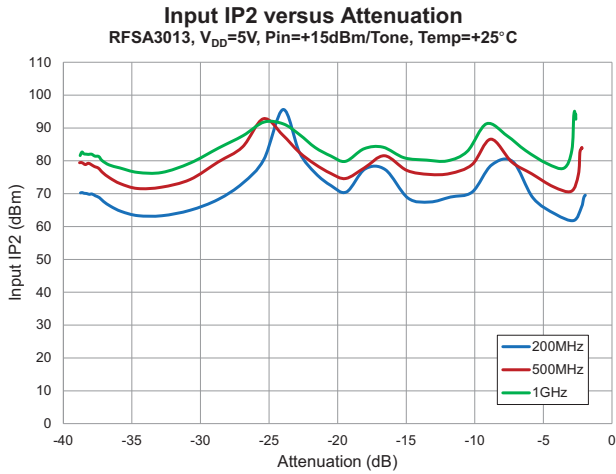

Measured Negative Attenuation Slope Performance

Note: Data includes PCB and connector losses

Relative Insertion Phase versus Voltage Control

RFSA3013, $V_{DD}=5V$, Temp=25°C

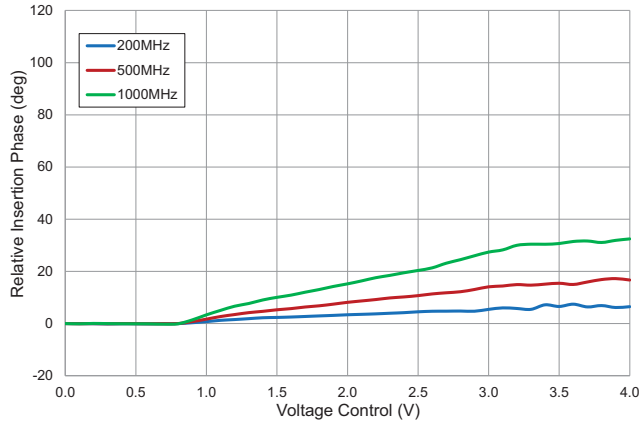

Relative Insertion Phase versus Insertion Loss

RFSA3013, $V_{DD}=5V$, Temp=25°C

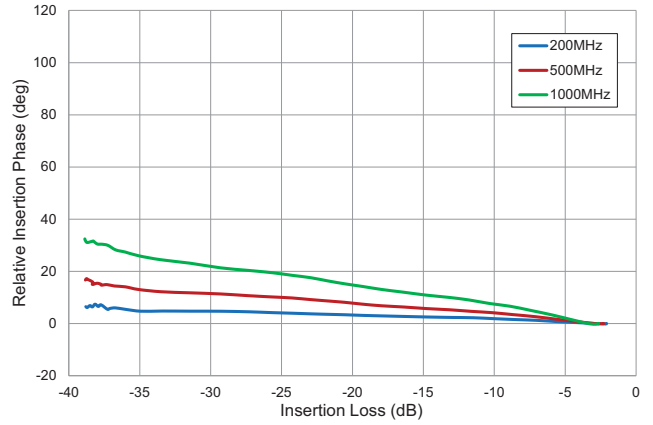

Insertion Loss Relative to +25°C

RFSA3013, RF 1GHz, $V_{DD}=5V$

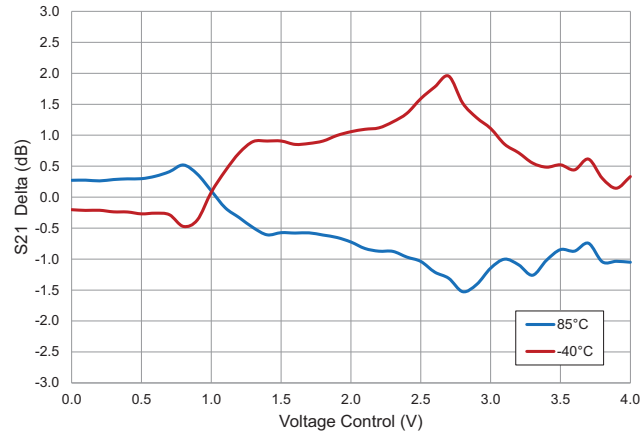

Measured Composite Performance: 79 Channel Loading

XMOD versus Frequency, 79 Channel
39dBmV Flat Input, Temp=+25°C

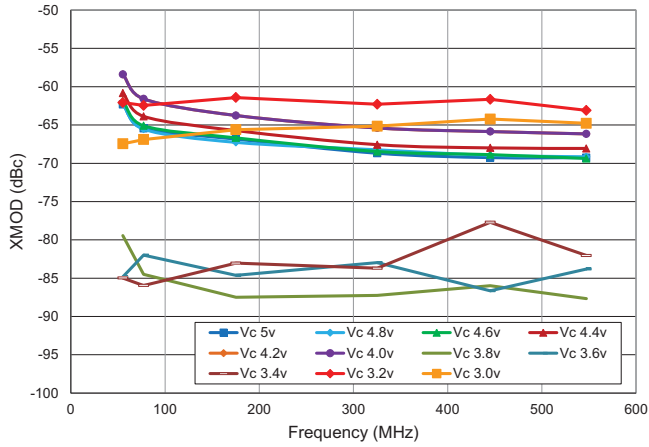

CTB versus Frequency, 79 Channel
39dBmV Flat Input, Temp=+25°C

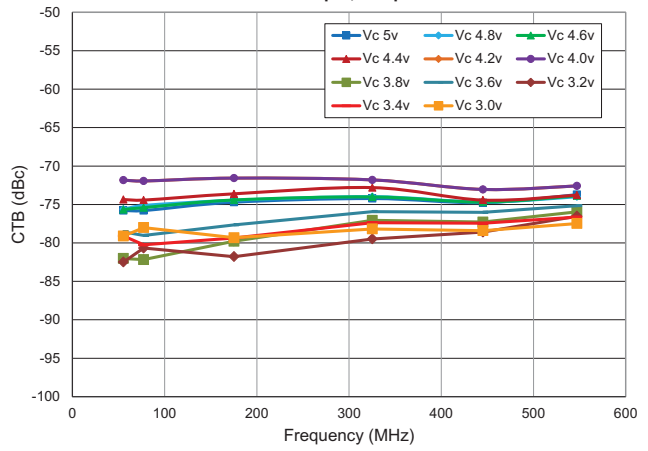

CSO Difference versus Frequency, 79 Channel
39dBmV Flat Input, Temp=+25°C

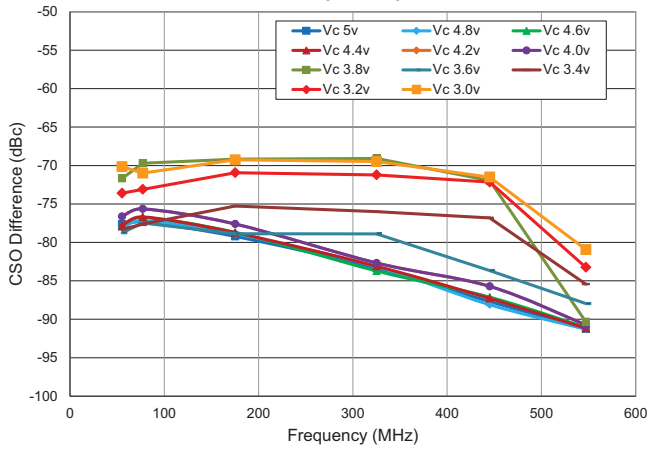

CSO Sum versus Frequency, 79 Channel
39dBmV Flat Input, Temp=+25°C

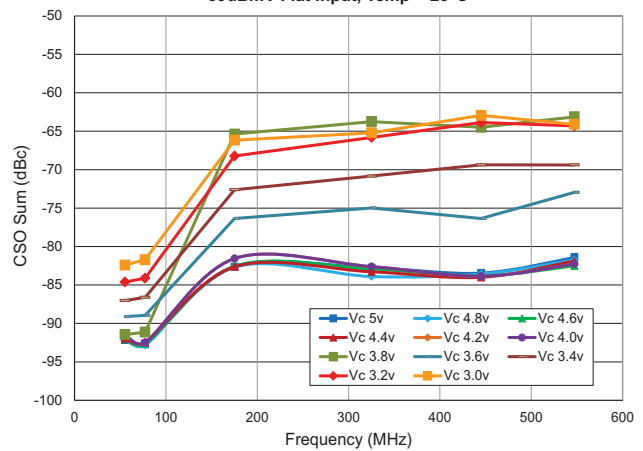

Measured Composite Performance: 112 Channel Loading

XMOD versus Frequency, 112 Channel
39dBmV Flat Input, Temp=+25°C

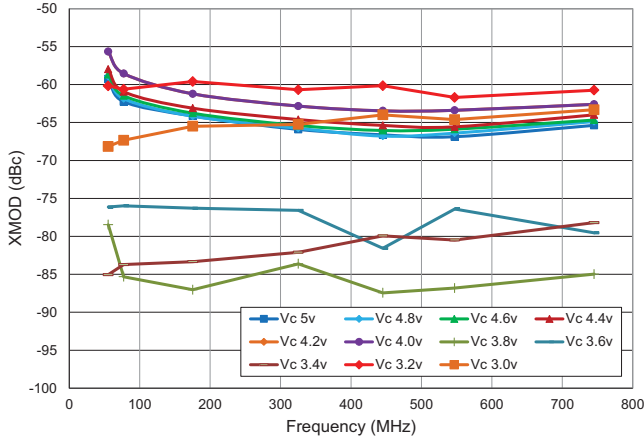

CTB versus Frequency, 112 Channel
39dBmV Flat Input, Temp=+25°C

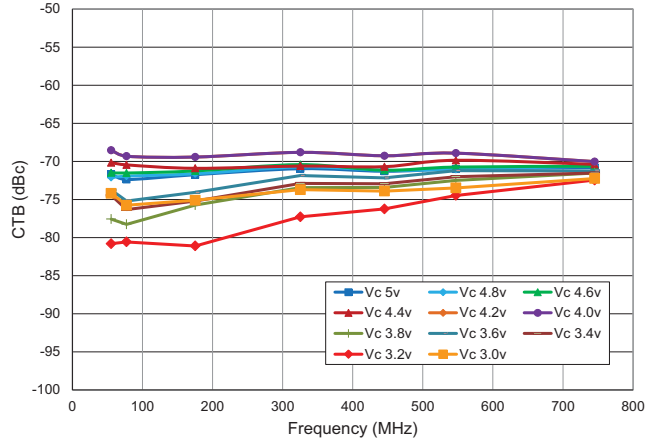

CSO Difference versus Frequency, 112 Channel
39dBmV Flat Input, Temp=+25°C

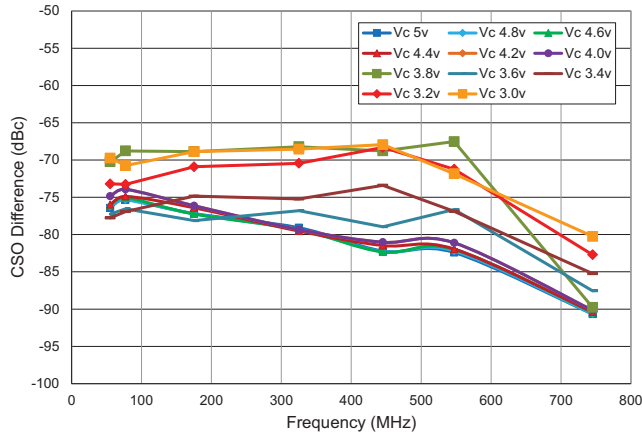

CSO Sum versus Frequency, 112 Channel
39dBmV Flat Input, Temp=+25°C

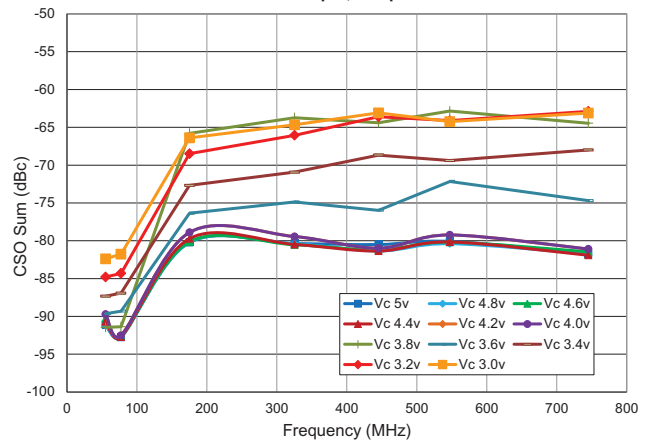

Pin Names and Descriptions

Pin	Name	Description
1	GND	Ground Pin
2	NC	No Connection. Do Not Connect to PC Board Ground Plane.
3	RFIN	RF Input. Use External DC Block. RF input must be this pin to insure linearity and thermal resistance specifications.
4	NC	No Connection. Do Not Connect to PC Board Ground Plane.
5	GND	Ground Pin
6	GND	Ground Pin
7	GND	Ground Pin
8	GND	Ground Pin
9	NC	No Connection. Do Not Connect to PC Board Ground Plane.
10	RFOUT	RF Output. Use External DC Block. RF output must be this pin to insure linearity and thermal resistance specifications.
11	NC	No Connection. Do Not Connect to PC Board Ground Plane.
12	GND	Ground Pin
13	GND	Ground Pin
14	VC	Attenuator Control Voltage
15	VDD	Supply Voltage (5V)
16	MODE	Attenuation Slope Control Set to Logic Low to Enable Negative Attenuation Slope. Set to Logic High to Enable Positive Attenuation Slope.
GND	GND	Exposed Package Ground Paddle is RF and DC Ground

PCB Patterns

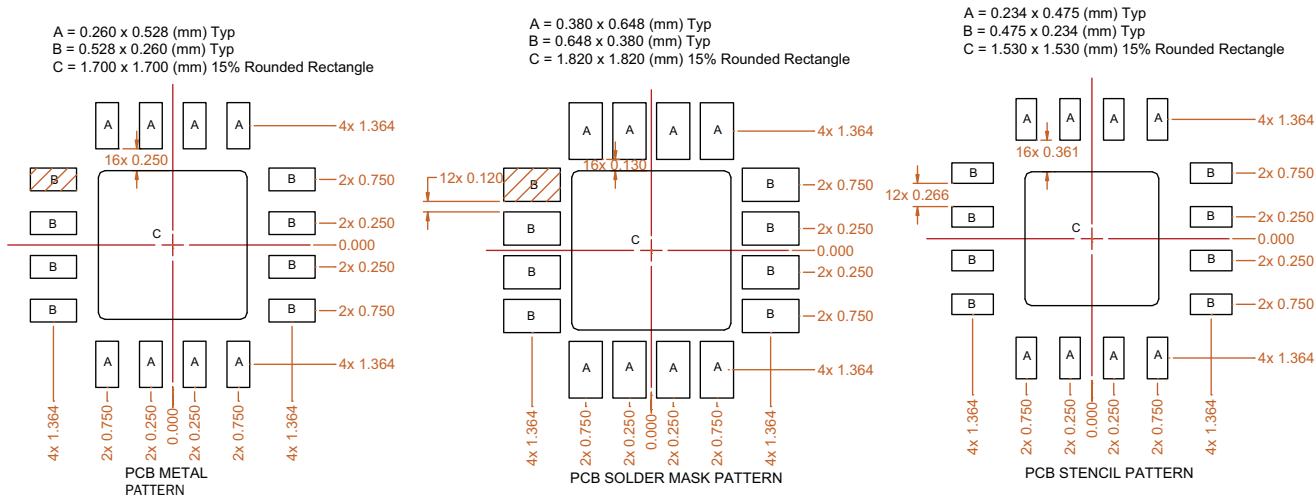

Thermal vias for center slug “C” should be incorporated into the PCB design. The number and size of thermal vias will depend on the application, the power dissipation, and the electrical requirements. Example of the number and size of vias can be found on the RFMD evaluation board layout.

Evaluation Board Schematic

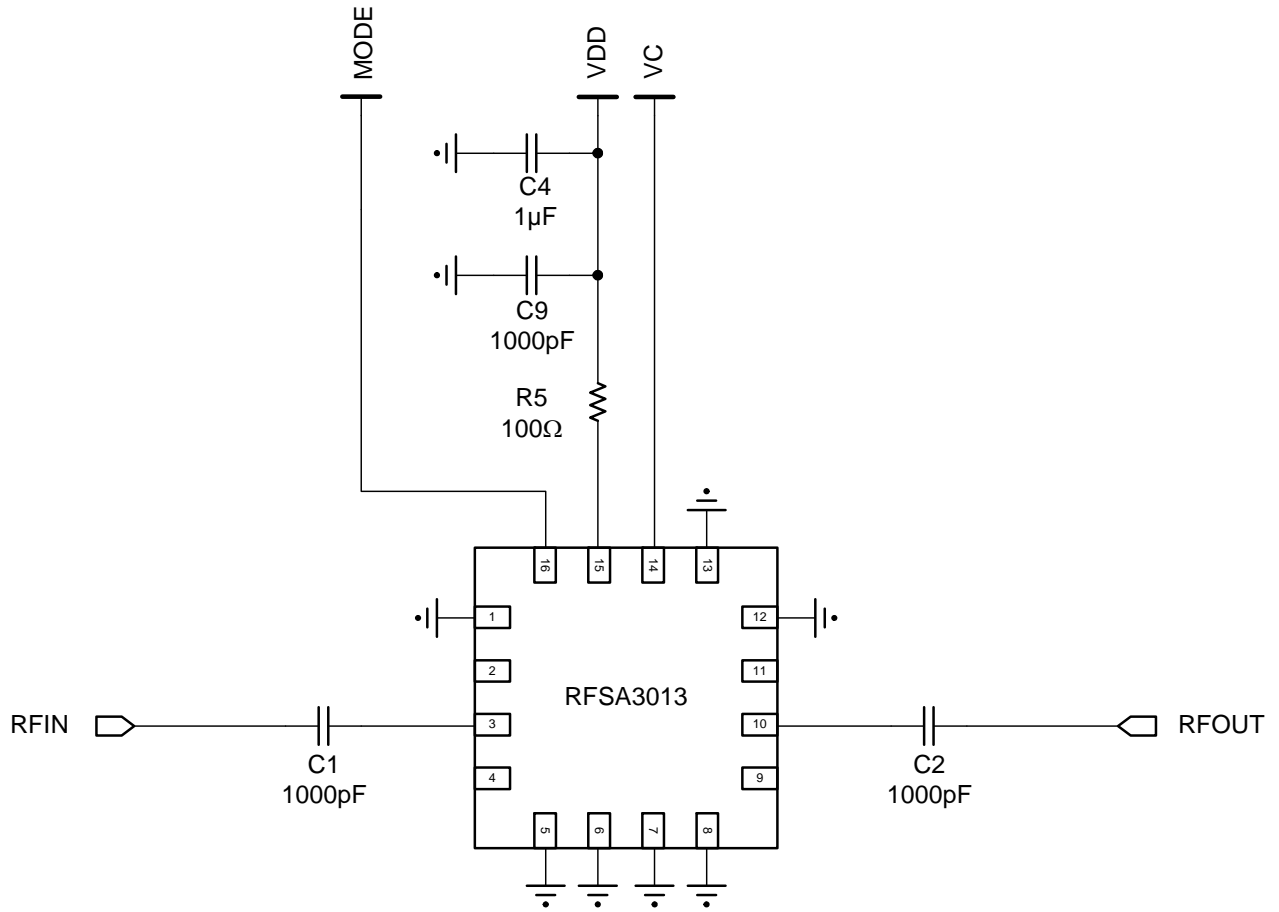

Evaluation Board Assembly Drawing

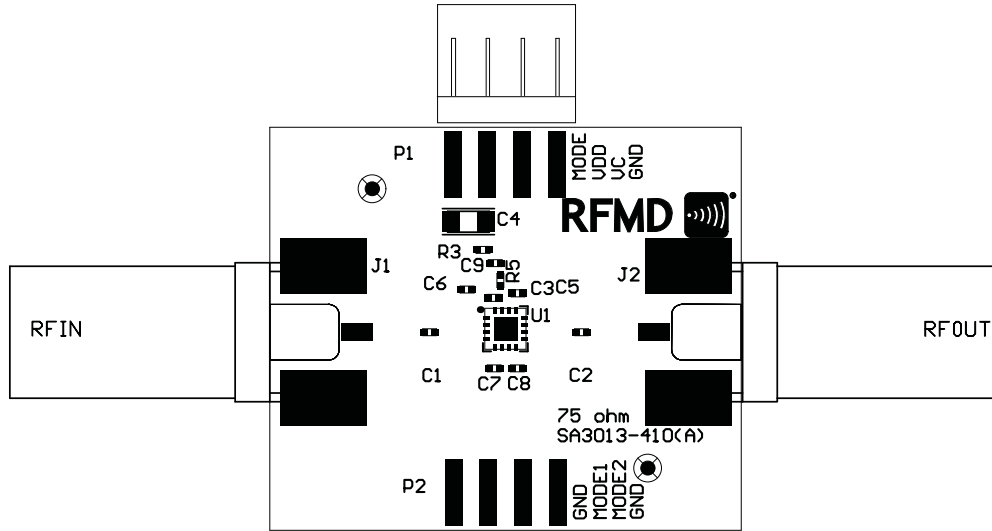

Evaluation Board Bill of Materials (BOM)

Description	Reference Designator	Manufacturer	Manufacturer's P/N
Voltage Controlled Attenuator VCA, 5V	U1	RFMD	RFSA3013
CONN, F, EDGE MOUNT, 30 MIL	J1-J2	Trompeter Electronics, Inc.	CBJE130-2
CONN, HDR, ST, 4-PIN, 0.100", T/H'	P1	MOLEX	22-28-4043
PCB, SA3013-410		DDI	SA3013-410(A)
CAP, 1000pF, 10%, 25V, X7R, 0402	C1-C2, C9	Murata Electronics	GRM155R71H102KA01D
CAP, 1μF, 10%, 16V, X7R, 1206	C4	Murata Electronics	GRM31MR71E105KC01L
RES, 100Ω, 5%, 1/16W, 0402	R5	Kamaya, Inc	RMC1/16S-101JTH
DNP	C3, C5-C8	N/A	N/A
DNP	R3	N/A	N/A
DNP	P2	N/A	N/A

Package Drawing
0.9mm x 3mm x 3mm

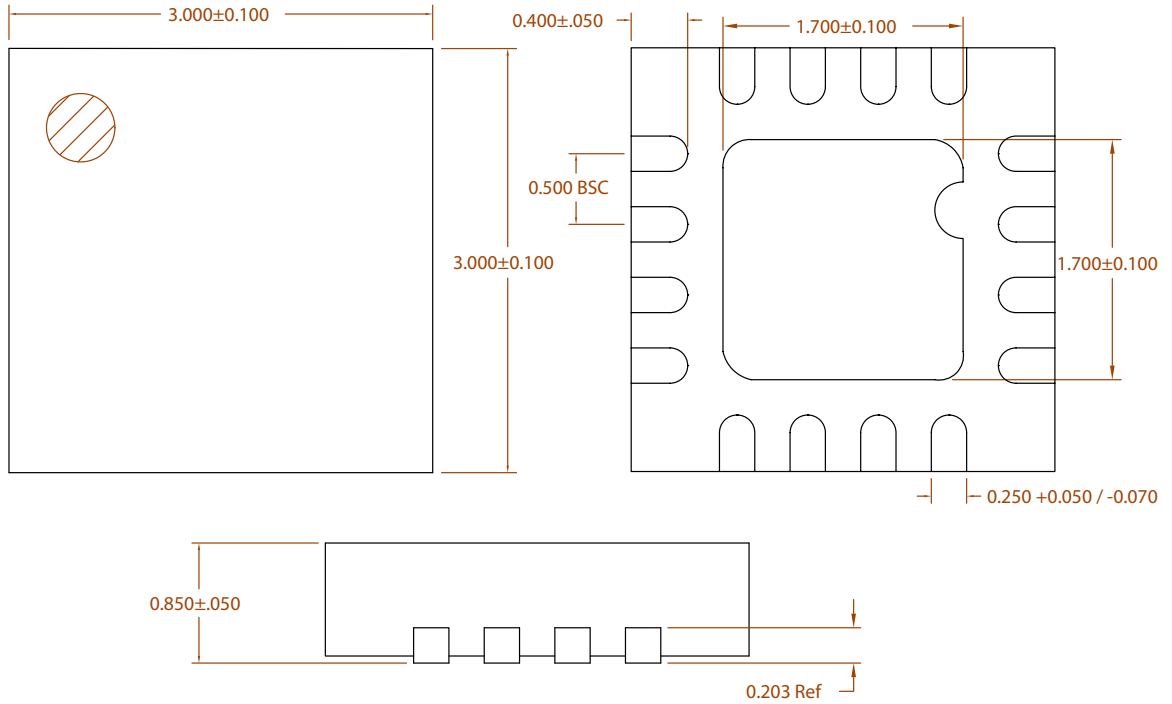

Branding Diagram
0.9mm x 3mm x 3mm

