

Using the MC1322X with External RF TX Amplification

1 Introduction

The MC1322x is a Freescale's ZigBee/IEEE 802.15.4 platform which incorporates a complete, low power, 2.4 GHz radio frequency transceiver, 32-bit ARM7 core based MCU, hardware acceleration for both the IEEE 802.15.4 MAC and AES security, and a full set of MCU peripherals into a 99-pin LGA Platform-in-Package (PiP).

The device provides a bi-directional RF radio port with an on board balun and TX/RX switch that allows direct connection to a single-ended 50-Ω antenna. This interface typically provides programmable output power from -30 dBm to +3 dBm, and the RX sensitivity of -96 dBm. In addition to the bi-directional port, a set of complementary TX amplifier ports are provided for use with an external power amplifier (PA).

Because of its low current and MCU processing power the MC1322x has found use in applications requiring longer range communication. Longer range implies use of external RF components to provide more transmit power and/or receive sensitivity.

Contents

1 Introduction	1
2 Design Background Information	3
3 Lab Setup and Measurement Methodology .	8
4 Measurements at Highest Usable Power Setting (0x0C)	8
5 Summary	18
Appendix A Channel 26 Limitations	19



To facilitate greater range:

- The standard single-ended port is used as the receive port with appropriate RF switches:
 - An external RX LNA can be used.
 - An external single-ended PA can also be used
- The separate complementary transmit outputs also allow direct connection to an external PA and the single-ended port defaults strictly to the RX port (with or without an external LNA).

The purpose of this application note is to provide guidance to the user when applying external power output amplification to the MC1322x. The user must be aware of country specific regulatory signal requirements and limits. This note provides the MC1322x output spectrum characteristics and guidance on adding an external PA to provide greater TX output power. Beyond determining/showing the basic spurious response of the device, it is also shown how amplification can be used to boost the 802.15.4 signal and still meet the limitations set by the FCC regulatory department of the U.S. government.

NOTE

- The user should be familiar with the IEEE 802.15.4 Standard and its requirements for the 2450 MHz PHY RF signal
- The user should be familiar with the MC1322x device as described in the Freescale MC13244V Data Sheet and MC1322x Reference Manual available at www.freescale.com/zigbee.
- Although guidance and recommendations on use of the MC1322x device are given in this application note, **IT IS THE USER'S RESPONSIBILITY TO PROVIDE PROPER COMPLIANCE TO ALL REGULATORY REQUIREMENTS IN THE COUNTRY OF INTENDED USE.** Freescale takes no responsibility for an end user's application.

2 Design Background Information

This section provides background information necessary to understand MC1322x RF transmission, FCC requirements for spurs/out-of-band signals, and measurement procedures.

2.1 FCC Spurious Limits

The FCC limits spurious signals emanating from a transmitter to prevent interference with other transmitted signals both within the band and outside the band. The 2.4 GHz ISM band (see [Figure 1](#)) is defined as the band of frequencies from 2.400 MHz to 2.483.5 MHz. The IEEE 802.15.4 Standard shares this band with the IEEE 802.11 (Wi-Fi) and Bluetooth wireless standards. The IEEE 802.15.4 Standard has 16 set channels in the band, each channel having a 2 MHz occupied bandwidth, and channel spacing is 5 MHz.

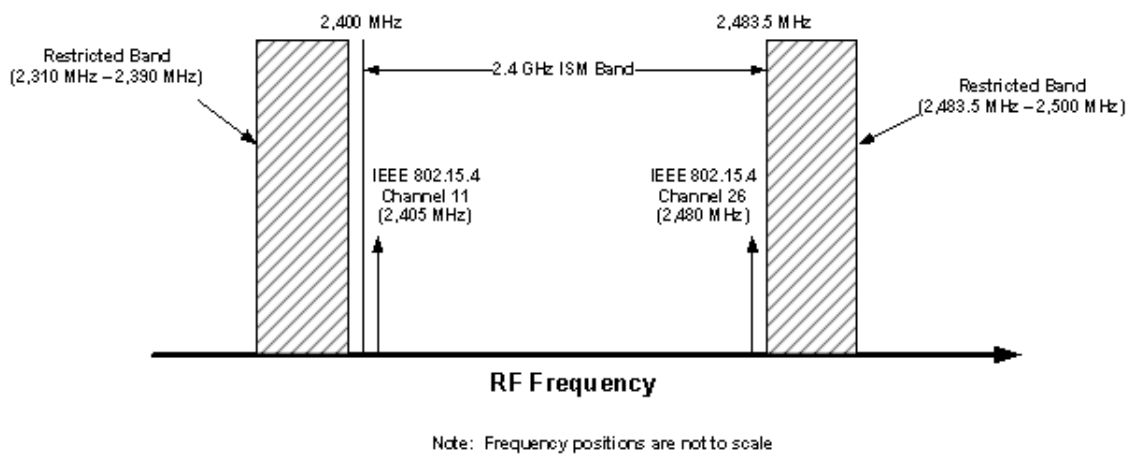

Figure 1. 2.4 GHz ISM Band with Adjacent Forbidden Bands.

As shown in [Figure 1](#), the lowest channel or Channel 11 is illustrated at 2.405 MHz and the highest channel or Channel 26 is also illustrated at 2.480 MHz. Further impacting spurious limits are two nearby FCC restricted bands:

- 2483.5 MHz - 2.500 MHz restricted band - note that this band is immediately adjacent to the high side of the ISM band
- 2.310 MHz - 2.390 MHz - this band is separated from the lower ISM band limit by 10 MHz.

The spurious limits under consideration are as follows:

1. Conducted Emissions Test per FCC Part 15.247(c) – this conducted measurement test requires that all harmonics and spurious emissions levels be no less than 20 dB down from the carrier level, i.e., ≥ 20 dBc. This applies both within and outside the frequency band:
 - For this paper, the close-in spurious emissions are of more concern
 - Harmonics can be suppressed by applying appropriate filters
 - This measurement is made using spectrum analyzer settings of 100 KHz RBW and 300 KHz VBW

2. Radiated average absolute power (uV/M) per FCC Part 15.247 (c) along with limits in Part 15.209 and Part 15.205 – this limit applies outside of the band. The FCC limit is stated as a radiated condition under a given set of conditions. This is difficult and expensive to accomplish, and as a result, an equivalent conducted measurement technique is used to evaluate the transmitter:
 - An approximate mathematical conversion from a radiated number is made
 - FCC requirement translates to ≤ -41.2 dBm (absolute)
 - Spectrum analyzer settings are:
 - 1 MHz RBW
 - 10 Hz VBW
 - Peak detector with Max Hold
 - Apply Duty Cycle Correction Factor (DCCF).
3. Radiated peak absolute power (uV/M) per FCC Part 15.247 (c) along with limits in Part 15.209 and Part 15.205 – the same discussion regarding radiated versus conducted measurement as for Paragraph 2 applies:
 - FCC requirement translates to ≤ -21.2 dBm (absolute)
 - Spectrum analyzer settings are:
 - 1 MHz RBW
 - 1 MHz VBW
 - Peak detector with Max Hold
 - Do Not apply DCCF

NOTE

For more information on FCC requirements and testing, see the following:

- CFR 47 FCC Part 15 – available from the FCC web site. Sections 35.205.209.247
- FCC Publication 558074 – gives details on measuring digital radios; available from the FCC web site (use Google search)
- “Simplifying FCC Compliance for 802.15.4 2.4 GHz Devices” – White paper by Glen Moore, Wireless/EMC Manager, National Technical Systems

2.2 Applying External Amplification (PA) to the MC1322x

In standard non-amplified usage, the MC1222x radio transmit spectrum easily meets FCC requirements as designed. However, due to customer demand for extended range capability, some customers want to add external amplification for higher TX output power. When using a PA, customers must be cautious because the MC1222x transmit spectrum has high spurs at 24 MHz intervals inherent in its radio design.

To facilitate PA design, this application note provides guidance on how to implement external gain to provide a full 20 dBm output power and still meet FCC spurious requirements. This task entails two radio usage restrictions:

1. Eliminating use of the upper band edge frequency of Channel 26

- Restricting the radio to certain power levels on all remaining channels - Freescale provides a software utility mode called “PowerLock” that provides these restricted power levels automatically under software control

The following sections of this application note describes why these restrictions are necessary.

2.2.1 Hardware Implementation with an External PA

The following items apply when adding an external PA to the MC1322x:

- As shown in [Figure 2](#), a PA can be applied in one of two ways -
 - With the use of appropriate antenna switches, the PA can be used with the singled-ended port of the MC1322x. The switches must be controlled as to enable the PA path for TX, and a secondary path for RX. In the figure, an LNA is shown but not required.
 - Alternatively, the secondary complementary differential outputs of the MC1322x can be used with a balun to drive a single-end connection to the PA. An antenna switch is still required to enable the single-ended port of the MC1322x as the RX path and the un-amplified TX path if used.
- Depending on the application and the type of PA or integrated RF module in use, a regulated power supply may be required by the FCC.
- Out-of-band (OOB) filtering will be required following signal amplification in the PA in order to suppress harmonics to meet FCC requirements.

Finally, to determine the allowable power for a given PA and required OOB filtering with the MC1322x PowerLock settings, the user must evaluate the MC1322x output spectra under the different channel setting and programmed power levels.

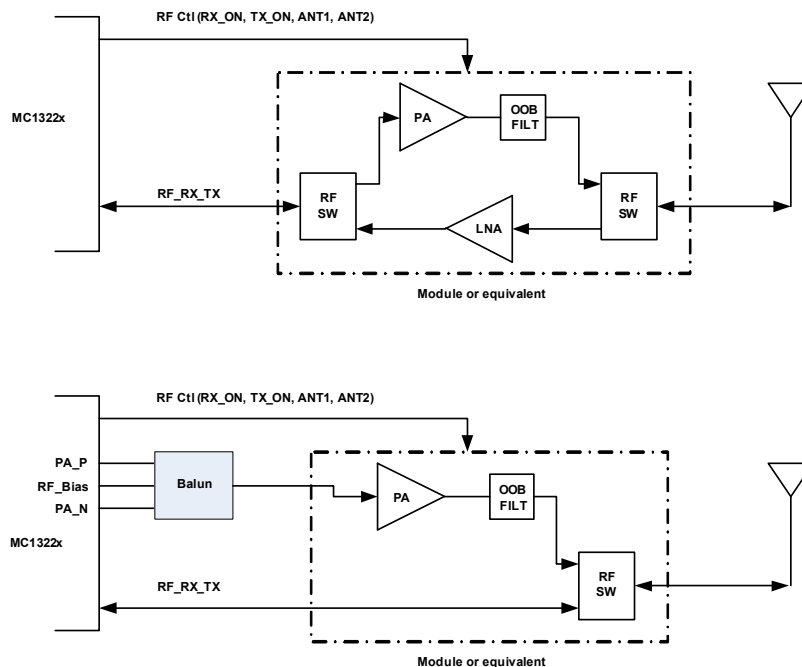

Figure 2. Adding External PA to MC1322x

2.3 Programming MC1322x Transmit Power

NOTE

As stated previously, using the MC1322x with a PA requires that Channel 26 is disabled and usable programmable power is limited. Freescale provides software utilities to control this restricted mode called Powerlock. Users should employ these functions as supplied in the Freescale software Codebases.

The MC1322x TX power levels are set by software utility commands and there are two distinct modes:

- Standard power levels - for non-amplified applications
- “Powerlock” - restricted power level operation for use with external PAs. For powerlock mode:
 - The highest 802.15.4 channel (Channel 26) is disabled, and its use is disallowed
 - The allowable power levels are restricted and optimized to allow the amplified spectrum to meet FCC requirements.
 - The user must enable/disable the powerlock via a software function call.

Table 1 lists the available typical transmit power levels for normal and powerlock modes.

Table 1. MC1322x PA Level vs. Output Power

Power Level (Hex)	Transmit Power ¹ (dBm)	Available for PowerLock ²
0	-30	Yes
1	-28	Yes
2	-27	Yes
3	-26	Yes
4	-24	Yes
5	-21	Yes
6	-19	Yes
7	-17	Yes
8	-16	No
9	-15	No
A	-11	No
B	-10	No
C	-4.5	Yes
D	-3	No
E	-1.5	No
F	-1	No

Table 1. MC1322x PA Level vs. Output Power (continued)

Power Level (Hex)	Transmit Power ¹ (dBm)	Available for PowerLock ²
10	1.7	No
11	3	No

¹ The listed output power is measured at the RF_RX_TX port of the device. See Data Sheet for Power level tolerance.

² When Power Lock is enabled only the power settings shown as available may be used. This feature is intended for use with an external PA.

2.4 Evaluating MC1322x TX Performance to Determine Required PA Parameters

Use the following procedures to evaluate MC1322x transmission characteristics.

2.4.1 Method of Determining Proper PA Performance

Ensure the following:

- Collect the spurious data for all of the power steps in PowerLock mode at the intended frequencies of use. As previously noted, Channel 26 is not available.
- Determine the worst case spurious levels for each power level for all frequencies under test.
- Compare those levels to the FCC limitations on spurious power to determine the margin to the specification. The margin to specification is the amount of gain that can be theoretically applied to the channel power at each power step and still meet FCC limitations with no margin.
- Select a PA with a gain parameter that is based on the "margin to specification" data. An optimum power step will allow the application desired power level to be achieved and still be below the "margin to specification" by 3 dB while still meeting the FCC requirements with some margin.

2.4.2 Limitations

This application note provides an example of how to collect data and select amplifier characteristics based on the PowerLock mode:

- Because of the proximity to the forbidden bands on both ends of the 802.15.4 band, the data that is most likely to cause a spurious rejection to the FCC requirements are the lower and upper most two channels. Those channels are 11, 12, 25 and 26, or 2405 MHz, 2410 MHz, 2475 MHz and 2480 MHz respectively - based on the data collected and the application's required power, it will need to be determined if additional channels need to be removed from use in the application.
- Channel 26 cannot be used when trying to use an amplifier with the MC1322x because the in-band high edge signal would be above the FCC limitation with the 802.15.4 modulation after signal amplification.

- Due to the variability of the spurious levels at each power step, the internal power step settings are not appropriate for ramping power with an amplifier attached. If variable power is required, then an external variable attenuator will need to be added between the output of the transceiver and the input to the PA.

The summary data for all the power steps for the channels listed are shown in tabular form at the end of this note for the MC1322x NCB.

This information also shows close-in (band edge) measurements as well as broadband measurements appropriate to show worse case spurious.

NOTE

When taking data, the part must be measured under all conditions of possible use. This includes all power settings and all channel frequencies. While not included here and not required per FCC, best practice is to test over temperature such that the radio meets FCC requirements.

3 Lab Setup and Measurement Methodology

The measurements shown in this document were made using Freescale's (FSL) MC1322x Network Node module. The output of the MC13224 is ac-coupled to an SMA RF connector which is then cabled to an appropriate spectrum analyzer. The transmit signal is generated via test software available through the Freescale BeeKit IDE.

NOTE

All of the following data were taken with the unit at Channel 11 (2405 MHz).

4 Measurements at Highest Usable Power Setting (0x0C)

This section provides various measurement details at the highest usable power setting. The 0x0C power setting has been optimized for spur suppression and is best suited for most extended range (ER) applications.

4.1 Conducted Broadband Spurious Measurements – Power Setting 0x0C

Figure 3 shows a broadband view of the spurious signals in the best case 0x0C power setting, conducted mode. In this mode, the spurious signals outside the operating band must be no greater than 20 dBc peak, using 100KHz RBW. If RMS averaging is used then the FCC requirement changes to 30 dBc.

- These data show that although there are some high spurs below band by 1.3 GHz, it easily meets the FCC requirement of 20 dBc.
- Most linear amplifiers are of bandwidth wide enough that the close-in lower and upper band spurs will be amplified by a similar amount as the fundamental signal. Therefore, it is likely that the spurs will maintain about the same amount of suppression after amplification as before amplification. Then it becomes necessary that the spurious amplification meets other FCC absolute power limitations covered below.

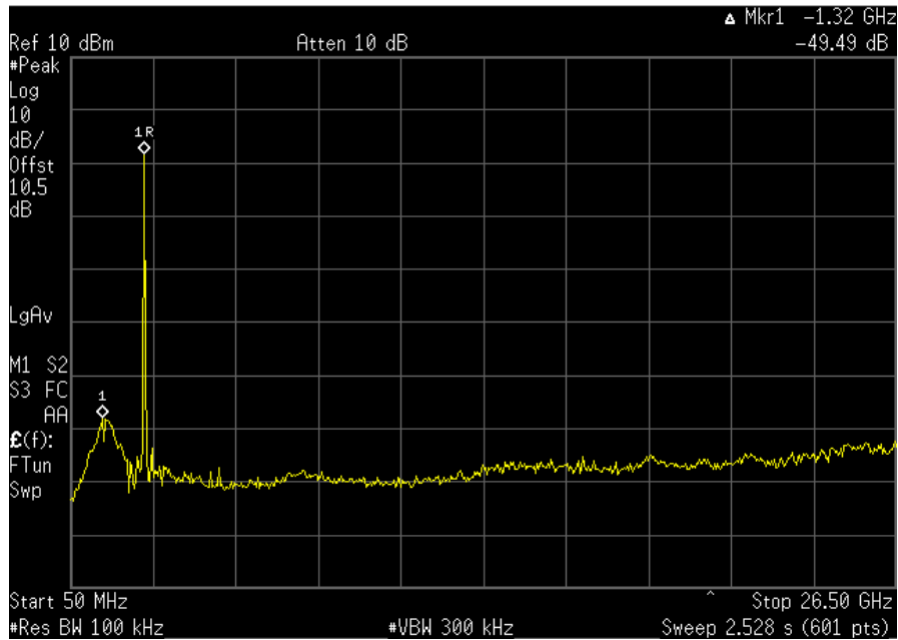

Figure 3. Power Setting 0x0C Conducted Broadband Spectrum

4.2 Conducted Spurious Band Edge (Lower Band Edge (LBE) and High Band Edge (HBE)) Measurements - Power Setting 0x0C

Figure 3 shows that the TX output spectrum passes a broad sweep at RBW = 100KHz and VBW = 300KHz, and then the next step is to take a close look near the band edges. This is where trouble can be observed with close-in spurs that are not seen with a broad sweep.

The following figures provide a close up view of the low and high side spectrum of the spurious signals in conducted mode referred to as HBE and LBE.

- Figure 4 shows the Low Band Edge spectrum (Channel 11 and a 0x0C power setting (best case)).
- Figure 5 shows the High Band Edge spectrum (Channel 11 and a 0x0C power setting (best case)).

The settings are the same as the broadband measurement but with a narrow span at the band edges.

NOTE

- The band edge for LBE is 2400 MHz and for HBE is 2483.5 MHz
- The band edge under observation is set to be the center of the graph to easily identify the spurs outside of the band versus the in-band spurs.
- Repeat this test for all three available band edge channels (Channel 26 is already excluded)

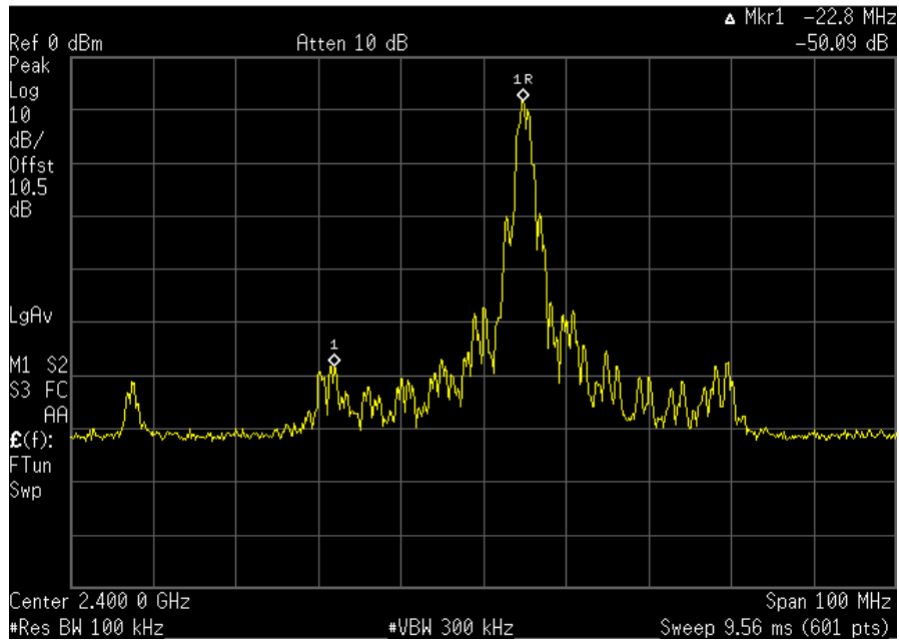

Figure 4. Channel 11 and Power Setting 0x0C Lower Band Edge Spectrum

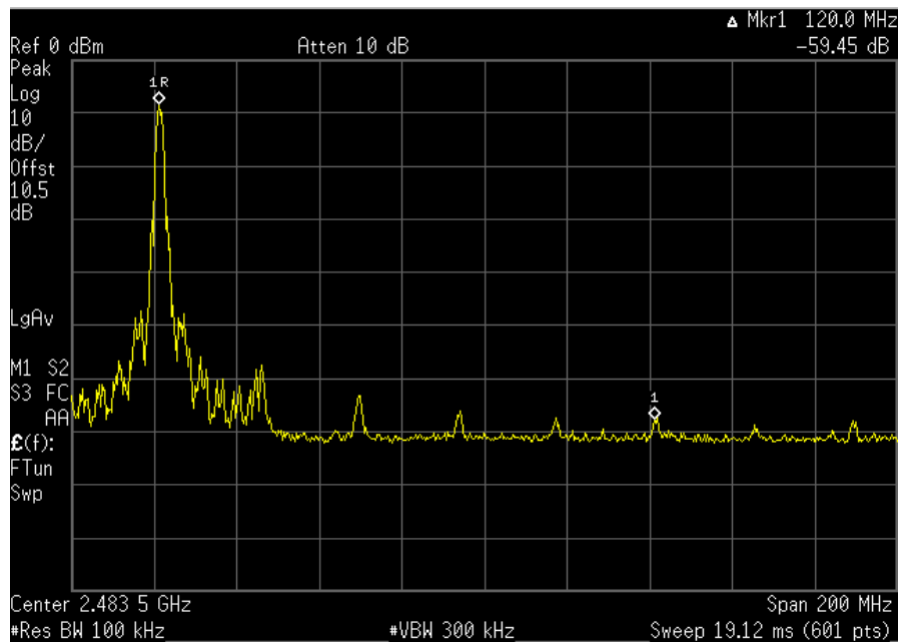

Figure 5. Channel 11 and Power Setting 0x0C High Band Edge Spectrum

NOTE

Although Channel 26 is not shown in Figure 5, this view demonstrates why Channel 26 is not used due to close-in spurs.

4.3 Radiated Spurious (RMS Average) Measurements – Power Setting 0x0C

The previous measurements show how the device passes the conducted spurious rejection of 20 dBc and will continue to do so under amplification. Radiated absolute power is observed next. The following figures show a broadband view of the spurious signals in radiated mode for best case power setting 0x0C. In this mode, the spurious signals outside the operating band must be less than 500 uV/M at 3 meters. However, in order to make this measurement in a lab without using an anechoic chamber, the results here show the data of a board which has bypassed the antenna and is ported directly to a spectrum analyzer by coax cable. Therefore, the roughly equivalent conducted measurement value was used for comparison. This loosely translates to -41.2 dBm average, using 1 MHz RBW.

For RMS averaging, set the VBW to 10 Hz and set the sweep time to be 500 seconds for a multi-gigahertz sweep. Alternately, the sweep can be sped up by taking multiple narrow band sweeps. Repeat this test using a VBW of 1 MHz for the peak test. The FCC requirement for the peak test is 20 dB above the average or -21.2 dBm. Both conditions must be met as required by FCC regulations. In this test, one is looking for spurious signals outside the operating band of 2400 to 2483.5 MHz. The example here is for a part set to Channel 11, and the High Band Edge is evaluated as well as the upper frequencies to 26 GHz. These measurements are then repeated for the Low Band Edge down to all of the lower band frequencies.

This process determines how much power is available at the 0x0C power setting, and then determines the power output goal. The difference is the minimum amount of gain required to meet that specification. For example, if the absolute minimum power for an application is 20 dBm and the minimum power out across all frequencies is -3.5 dBm then a minimum of 23.5 dB of gain is required to meet the 20dBm minimum output power. To guarantee that in production would require at least a 25 dB gain amplifier. Therefore, any measured absolute spur would get a gain of 25 dB added to it to determine it's absolute level after amplification. If therefore, a spur of -57 dBm average was measured, then the final level after amplification is $-57 + 25 = -32$ dBm which violates the -41.2 conducted equivalent. However, DCCF can be applied to the situation which may allow the average to pass depending on the application. This will be discussed later. The following data is collected into a table and analyzed at the end of this exercise.

NOTE

The Duty Cycle Correction Factor is applied to the average spurious data only. Also, the conditions and specifications below 1 GHz are specified to be measured using quasi-peak detection which is not covered in this application note. Therefore, consider any data below 1 GHz to be for a “first look” test. As in the conducted measurement case, [Figure 6](#) shows a broad sweep during the average spur measurement. Look for any obvious problem spurs and then zoom in around those as well as the band edges.

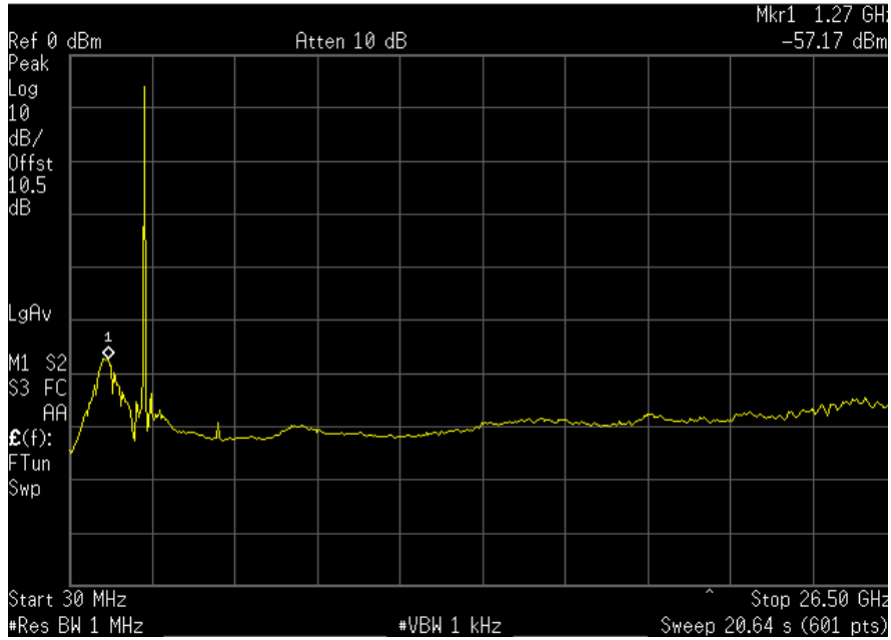

Figure 6. Power Setting 0x0C Radiated Broadband Spectrum for Peak Measurement.

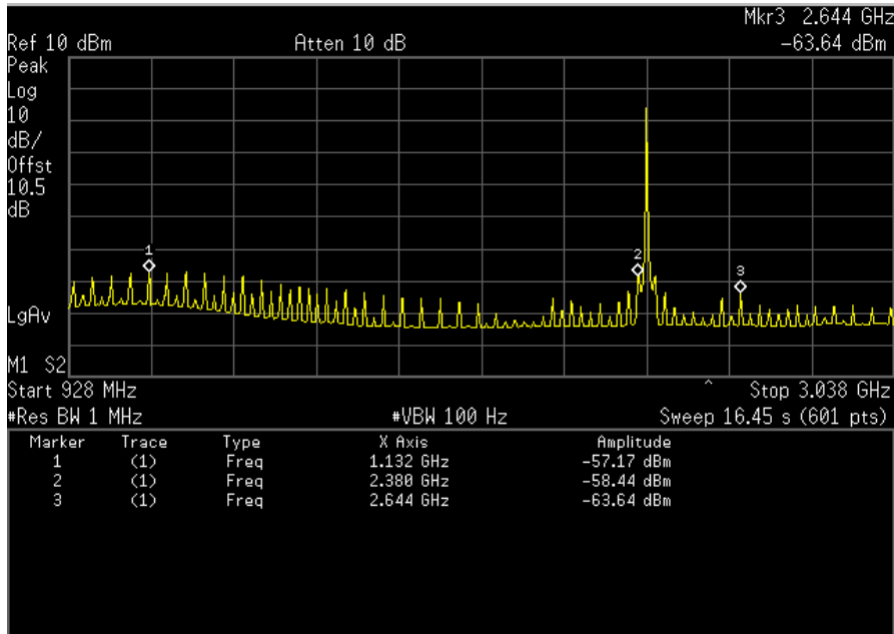

Figure 7. A closer look at Figure 6 (Note the forbidden band edge at Marker 2)

4.4 Radiated Spurious Band Edge - Average LBE and HBE Measurements - Power Setting 0x0C

Figure 8 shows a close up view of the low and high side spectrum of the spurious signals in radiated mode excluding the low band spur. The part is on Channel 11 at power setting 0x0C (The best setting). The settings are the same for the broadband measurement but with a narrow span at the band edges.

NOTE

The band edge for LBE is 2400 MHz and for HBE is 2483.5 MHz.

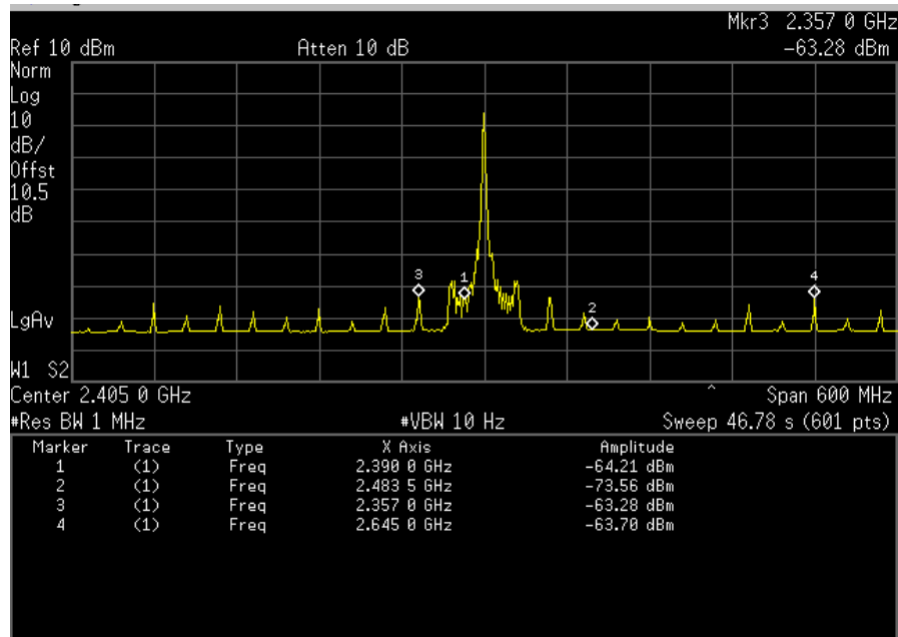

Figure 8. Power Setting 0x0C Radiated Spurious Band Edge Spectrum.

4.5 Using a Duty Cycle Correction Factor (DCCF)

Since the device is not operating at a 100% duty cycle, the FCC allows a duty cycle correction factor to be applied. Use of the DCCF requires that a peak power measurement be taken and the DCCF is applied to derive an average power value.

It has been determined that a probable worst case scenario is a 17% duty cycle. Under this condition, the DCCF would be a 15.4 dB correction. By applying this correction, many marginal measurements will then pass the FCC limit of -41.2 dBm. Since it is the average measurement which is usually the most marginal to the FCC limitations, then it is the most important to know what the use case is for determining the duty cycle and hence the DCCF. The following paragraphs will illustrate how to apply the DCCF to the spurious measurements.

4.5.1 How to Determine and Apply DCCF

The first step is to determine the signal duty cycle in a 100 ms time span. To do this, place the spectrum analyzer in zero span at the frequency of interest and make the following measurements:

1. [Figure 9](#) shows a close up view of multiple pulses within 100 ms window. Count the number of pulses within the 100ms period.

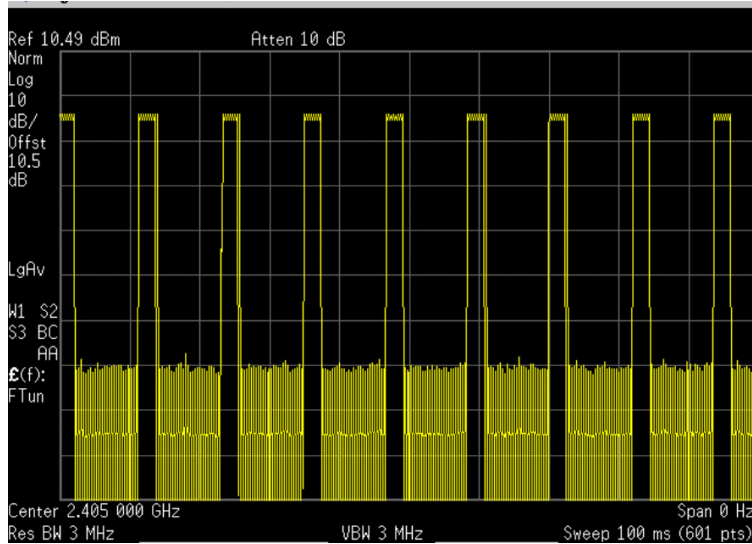

Figure 9. Total on-time in 100mS.

2. Figure 10 shows the on-time for one pulse. Determine the on-time.
3. To determine the duty cycle - a) First multiple the number of pulses (from Item 1) by the pulse on-time to get the total on-time, and then b) Divide that time by 100 ms to arrive at the duty cycle (as a fraction)

NOTE

An application may vary from this example by the number of pulses in 100mS and the duration of the pulse.

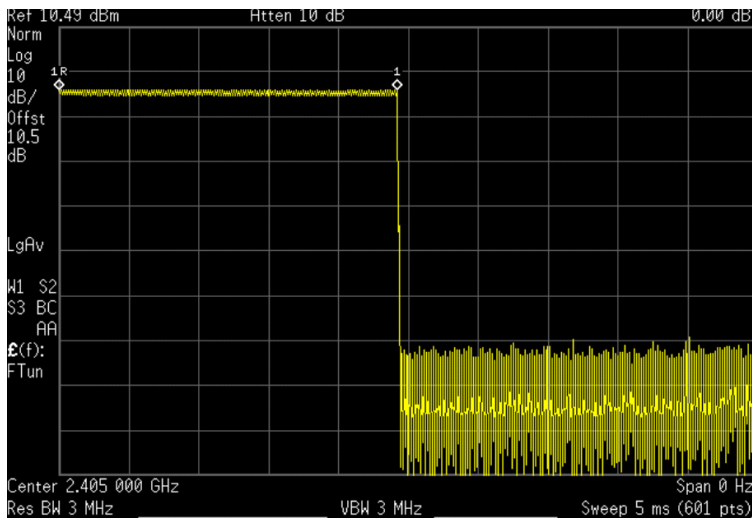

Figure 10. On-time for One Pulse.

4. Finally, take the log of the duty cycle and multiple by 20 - This result is the correction factor in dB's that can be applied to the average data that is collected in the previous measurements As an example: Given a duty cycle of 17%, the DCCF is -15.4 dB.

4.5.2 Applying the DCCF to the Measurements

Simply add the offset (more negative) to the average spur measurements to arrive at a corrected value. For the spur example given above. For example, the -32 dBm spur that was failing becomes -47.4 dBm. A spur that now passes with 6.2 dB of margin.

4.6 Radiated Spurious Peak – Broadband - Power Setting 0x0C

NOTE

DCCF cannot be applied to this measurement.

Figure 11 shows a broadband view of the spurious signals in radiated mode during peak measurements (VBW = 1MHz). In this mode, the spurious signals outside the operating band must be less than 20 dB above 500 uV/M at 3 meters. The calculated conducted equivalent requirement is -21.2 dBm peak, using 1MHz RBW and 1MHz VBW. Please note that the test conditions and limitations change below 1 GHz. Therefore, consider any data below 1 GHz to be for a first look test. This test has not been a problem at FCC certification.

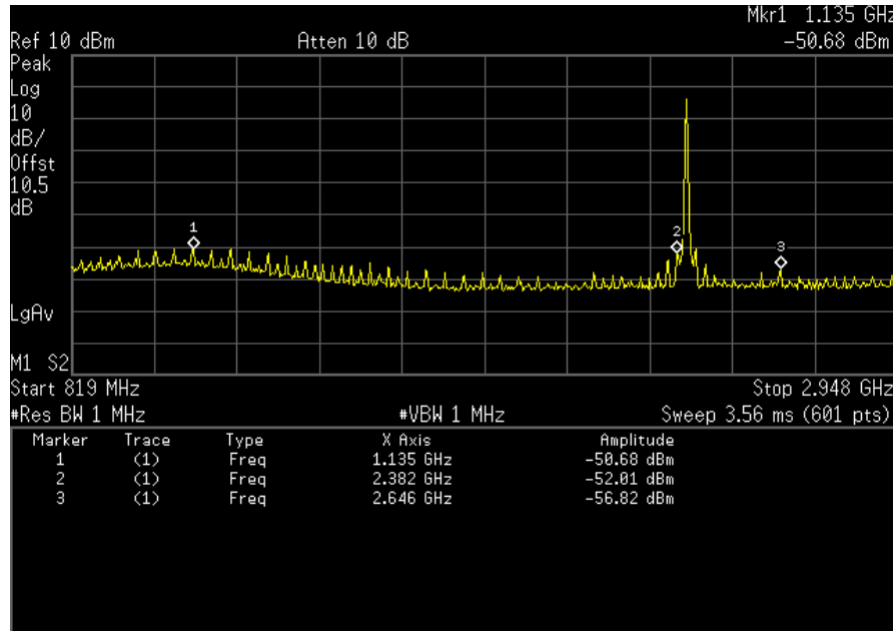

Figure 11. Power Setting 0x0C Radiated Broadband Spectrum.

This data was taken with the part in its best case spurious condition on Channel 11 at power setting 0x0C.

4.7 Radiated Spurious Band Edge – Peak LBE and HBE Measurements - Power Setting 0x0C

Figure 12 shows a close up view of the low and high side spectrum of the spurious signals in radiated mode. This part is in Channel 11 at power setting 0C (The best setting). The settings are the same as for the broadband measurement but with a narrow span at the band edges.

NOTE

The band edge for LBE is 2400 MHz and for HBE is 2483.5 MHz.

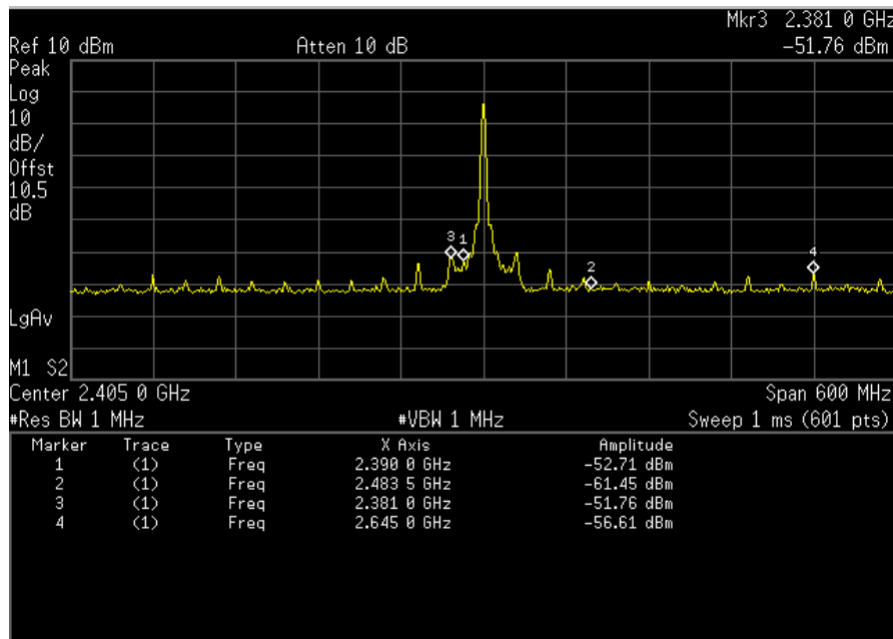

Figure 12. Power Setting 0x0C Radiated Spurious Band Edge Spectrum.

In Figure 12, note that markers 1 and 2 mark the lower and upper band edges. The highest spur outside of these two markers are noted. In this data, the highest spur is -51.76 dBm. As discussed earlier, a 25 dB gain amplifier will bring that spur to -26.76 dBm. That is better than 5 dB of margin to the FCC limit. Also note however that at Channel 26, the high side main signal has only a few dB of margin without any signal amplification and therefore cannot tolerate any signal boost thereby eliminating that channel from use in an extended range application.

4.8 Determining Gain Margin for Max Power (Max Power Setting)

Based on the previous data, the conducted spurious pass the FCC requirements. This section describes how to determine maximum power.

1. The worst case (highest peak) average and peak radiated absolute spur power must be compared to the power level of the limit to determine how much gain is allowed for this power setting.
2. Once the margin to spec is determined, it can be added to the absolute power at operating frequency to determine the max power available for this operating condition.
3. The data for Steps 1-2 must be taken at all intended power steps and at least the two lowest (Channels 11 and 12) and the highest allowable channel (Channel 25) to determine the worst case conditions (Channel 26 is disallowed). Freescale recommends using only the 0x0C setting as it is optimized for spur suppression.
4. Compare the worst case spur for each power step from the data gathered from Steps 1 - 3 above and determine the margin and max power
5. Find a suitable amplifier that will fit the gain requirement in order to meet the max power desired while still meeting FCC requirements with margin; the FCC limit is 1 Watt maximum conducted.

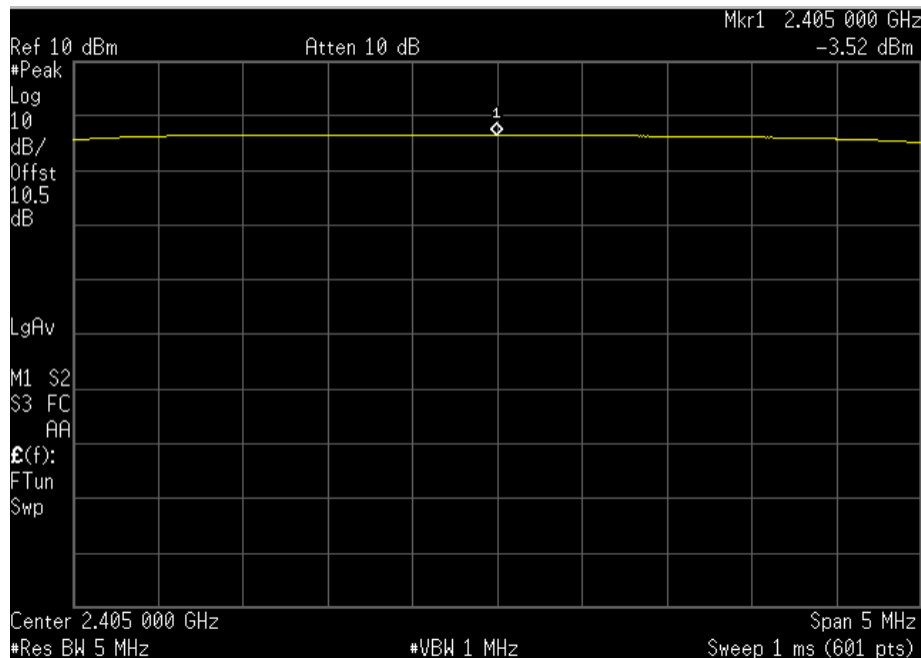

Figure 13. Typical Channel Power at 0x0C0C Setting

Using either channel power or this method results in approximately the same power out to determine how much gain is needed from an amplifier. By opening the RBW to 5 MHz with a 5 MHz span, the power output of the radio can be determined.

Refer to Table 3 in the appendix for a complete data set that was collected for extended range application.

5 Summary

This application note explains the limitations of the MC1322x transmit spectrum and how Freescale provides the PowerLock power settings to help implement applications with external amplification to meet FCC requirements. Also consider the following items:

- An excellent reference regarding IEEE 802.15.4 devices complying with FCC requirements can be found at:

http://www.ntscorp.com/pdf/whitepapers/6_NTS%2080215%20FCC%20white%20paper.pdf

- As shown in this app note, the MC1322x will not meet FCC requirements with all its power settings when used with an external amplifier. As a result, it is not possible to use the internal power settings to provide a smooth power ramp-up with an amplifier attached. Instead, try using either a bypass switch for the lower powers and/or an external variable attenuator between the MC1322x and the amplifier.

Appendix A

Channel 26 Limitations

This following data shows in detail the limitations of including Channel 26 in the calculations performed earlier in this application note. Also, data is presented that illustrates the extent of the spurs when a non-PowerLock mode is applied to the radio.

A.1 Determining External PA Gain at Four Band Edge Frequencies (Channels 11, 12, 25, and 26)

The following description gives an analysis of determining maximum allowable external gain with the MC1322x. The spurious limit is going to be worst case at the four band edge frequencies:

- Channel 11 or 2405 MHz
- Channel 12 or 2410 MHz
- Channel 25 or 2475 MHz
- Channel 26 or 2480 MHz

A.1.1 Data Analysis for All Band Edge Frequencies

Table A-1 includes worst case spurious for each power setting across all four band edge frequencies.

- The “Typical Power Out” column is the power out across the frequencies for that power setting.
- The “Margin to FCC Limit (dB)” column is the amount of range in dB’s from the worst case spur to the FCC Limit in Peak-Detection mode (1 MHz RBW).
- The “Max Power Out” column is the maximum power that can be achieved using this power setting if an amplifier could achieve the exact gain as the “Margin to FCC Limit” column added to the minimum power out. Note that in actual application, the user would need to allow for at least two to three dB of margin below the FCC Limit. Hence, the practical Max Power Out would be two to three dB below the Max Power Out listed here.

The data of Table A-1 show that for power settings of 0x0A and above (denoted by shaded background), the maximum power out is severely limited as determined by the max spur power versus the TX power out. After review of the individual channel data, it is determined that Channel 26 is the worst case offender limiting the power out in these upper power setting. Therefore, it is not practical to include Channel 26 when applying an external amplifier to boost range. To illustrate this conclusion, Table A-2 and the analysis in the next section will show that extended range is practical with Channel 26 blocked.

Table A-1. Radiated Power Output Spectra Data Collected from MC22X NCB Including 2480 MHz

Power Setting	Max Spur (dBm)	Typical Power Out (dBm)	Margin to FCC Limit (dB)	Max Power Out (All Frequencies) (dBm)
00	-64.87	-29.18	43.77	14.59
01	-63.47	-27.58	42.37	14.79
02	-62.1	-25.76	41	15.24

Using the MC1322X with External RF TX Amplification Application Note, Rev. 0.0

Table A-1. Radiated Power Output Spectra Data Collected from MC22X NCB Including 2480 MHz

Power Setting	Max Spur (dBm)	Typical Power Out (dBm)	Margin to FCC Limit (dB)	Max Power Out (All Frequencies) (dBm)
03	-61.17	-24.27	40.07	15.8
04	-60.08	-22.58	38.98	16.4
05	-58.85	-20.58	37.75	17.17
06	-55.67	-18.15	34.57	16.42
07	-54.05	-15.91	32.95	17.04
08	-52.85	-14.8	31.75	16.95
09	-52.22	-13.9	31.12	17.22
0A	-41.47	-9.73	20.37	10.64
0B	-40.31	-8.73	19.21	10.48
0C	-41.98	-3.93	20.88	16.95
0D	-36.68	-3.5	15.58	12.08
0E	-33.75	-1.06	12.65	11.59
0F	-33.31	-0.61	12.21	11.6
10	-31.29	1.82	10.19	12.01

A.1.2 Data Analysis for Three Band Edge Frequencies Eliminating Channel 26 (Channels 11, 12, and 25)

Table A-2 includes worst case spurious for each power setting across the three frequencies which excludes the upper most channel, Channel 26 (2480 MHz). The calculated maximum power out for many power settings of 0x05 and above have been significantly improved (denoted by shaded background) by the exclusion of Channel 26. See addendum for the data analysis that includes Channel 26.

- The “Typical Power Out” column is the power out across the frequencies for that power setting.
- The “Margin to FCC Limit (dB)” column is the amount of range in dB’s from the worst case spur to the FCC Limit in Peak-Detection mode (1 MHz RBW).
- The “Max Power Out” column is the maximum power that can be achieved using this power setting if an amplifier could achieve the exact gain as the “Margin to FCC Limit” column added to the minimum power out. Note that in actual application, the user would need to allow for at least two to three dB of margin below the FCC Limit. Hence, the practical Max Power Out would be two to three dB below the Max Power Out listed here.

Table A-2. Radiated Power Output Spectra Data Collected from MC22X NCB Excluding 2480 MHz

Power Setting	Max Spur (dBm)	Margin to FCC Limit (dB)	Max Power Out (All Frequencies) (dBm)
00	-64.87	43.77	14.59
01	-63.47	42.37	14.79
02	-62.1	41	15.24
03	-61.17	40.07	15.8
04	-60.08	38.98	16.4
05	-59.3	38.2	17.62
06	-58.12	37.02	18.87
07	-56.08	34.98	19.07
08	-56.1	35	20.2
09	-55.49	34.39	20.49
0A	-41.47	20.37	10.64
0B	-40.31	19.21	10.48
0C	-50.74	29.64	25.71
0D	-42.36	21.26	17.76
0E	-33.75	12.65	11.59
0F	-33.31	12.21	11.6
10	-35.97	14.87	16.69

A.2 Analysis / Establishing PowerLock PA Settings

Based on the data of [Table A-1](#) and [Table A-2](#), programming is provided for “PowerLock” settings to help those who use external amplification. The PowerLock utility does the following:

- Disables Channel 26 to prevent its use when amplified
- Limits allowed Power Settings within PowerLock - these allow highest amplified power out. Referring to [Section 2.3](#), “[Programming MC1322x Transmit Power](#)”, these power setting are 0x00 through 0x07 and 0x0C.

In this section, various measurements are provided at power setting 0x0B in order to demonstrate why PowerLock mode only allows the optimized power setting of 0x0C of the higher settings to drive an external PA.

A.2.1 Conducted Spurious – Broadband Power - Power Setting 0x0B

Figure A-1 shows a broadband view of the spurious signals in conducted mode. In this mode, the spurious signals outside the operating band can be no greater than 20 dBc peak, using 100KHz RBW. If RMS averaging is used then the FCC requirement changes to 30 dBc. This conducted data was taken with the part in its worst case spurious condition of power setting 0x0B of Channel 11.

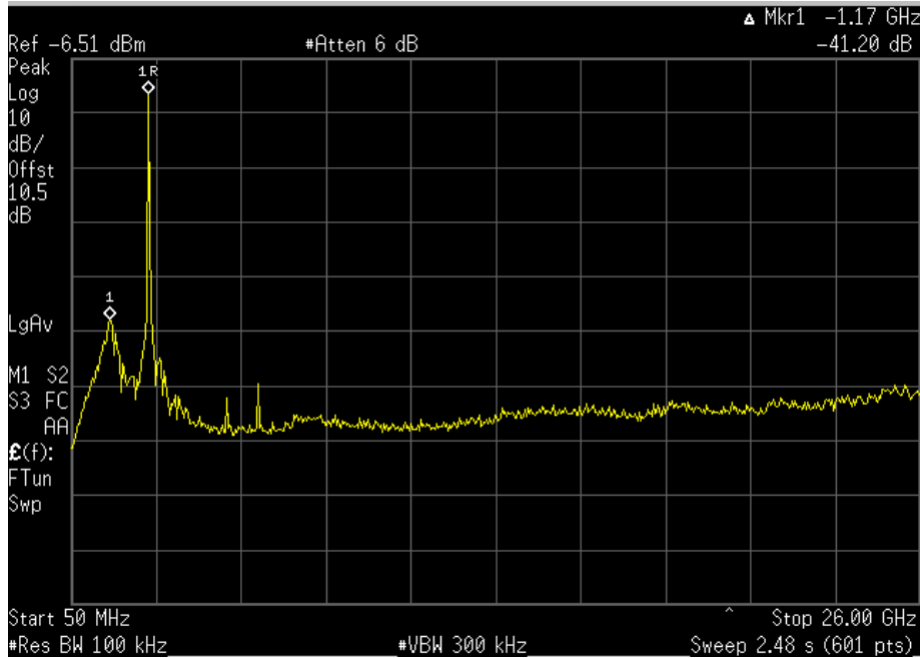

Figure A-1. Power Setting 0x0B Spurious Spectra in Conducted Mode (Broadband View)

A.2.2 Conducted Spurious Band Edge (Lower Band Edge (LBE) and High Band Edge (HBE)) Measurements - Power Setting 0x0B

Figure A-2 and Figure A-3 provide a close up view of the low and high side spectrum of the spurious signals in conducted mode. The device is at Channel 11 at power setting 0B which is a worst case setting. The settings are the same as for the broadband measurement but with a narrow span at the band edges.

NOTE

The band edge for LBE is 2400 MHz and for HBE is 2483.5 MHz.

Figure A-2 shows that the spur levels for the conducted measurements meet the 20 dBc both in and out of band.

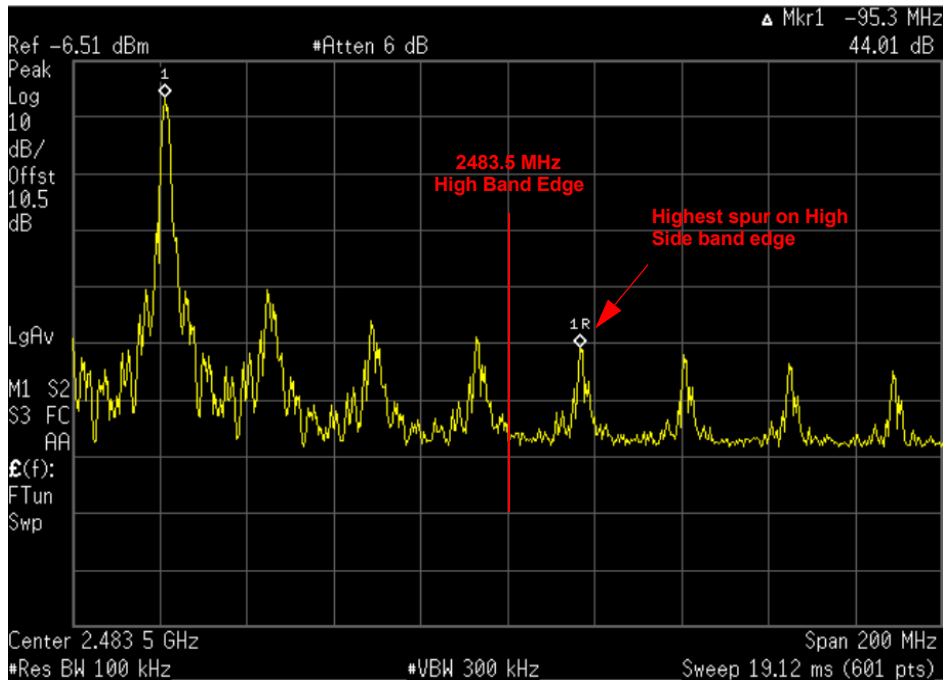

Figure A-2. Power Setting 0x0B Conducted Spurious High Side Band Edge Spectrum

Figure A-3 shows that the spur levels for the conducted measurements meet the 20 dBc both in and out of band. However, the following tests reveal that 0B is not a usable power setting for driving external PA's.

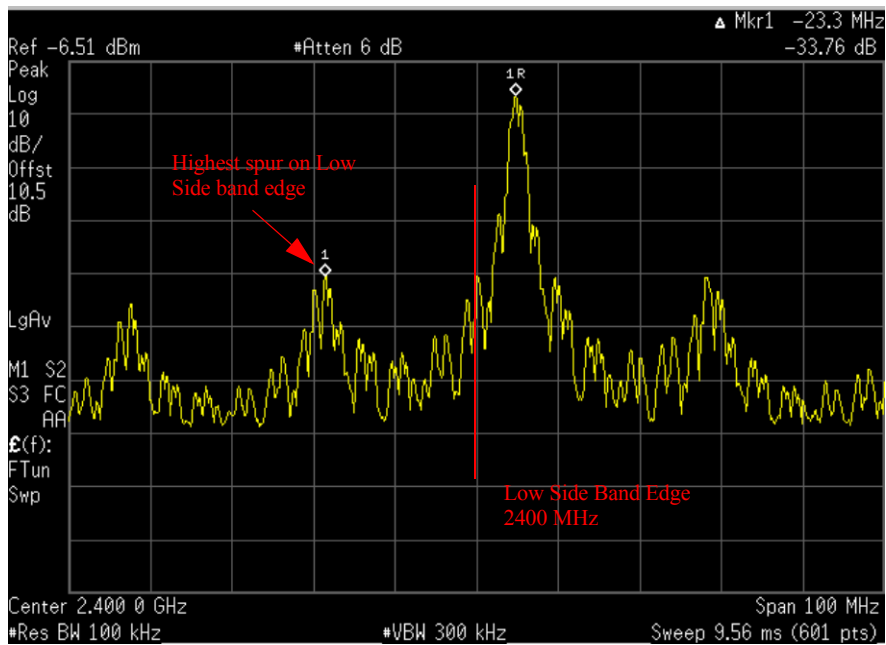

Figure A-3. Power Setting 0x0B Conducted Spurious Low Side Band Edge Spectrum

A.2.3 Radiated Spurious Spectrum (Average) – Broadband - Power Setting 0x0B

Figure A-4 provides a broadband view of the spurious signals in radiated mode, and Figure A-5 captures only the low band spurious and band edges. For RMS averaging, set the RBW to 1 MHz and the VBW to 10 Hz. In this mode, the spurious signals outside the operating band must be less than 500 uV/M at 3 meters (-41.2 dBm average conducted equivalent). Then re-measure using VBW of 1 MHz for the peak test. The FCC requirement changes for the peak test to -21.2 dBm. Both conditions must be met.

NOTE

The DCCF is applied to the average spurious data only.

This radiated equivalent data was taken with the part in its worst case spurious condition at power setting 0x0B.

Figure A-4 shows some spurs at 1.27 GHz and some additional spurs close in to the operating band. The 1.27 GHz spur meets the limit set by the FCC of -21.1 dBm. However, the level is going to limit how much gain can be added to the operating band and still meet the FCC limit. Additionally, the close-in spurs will also be looked at in more detail. The worst of these two sets of spurs will dictate how much PA gain can be added externally.

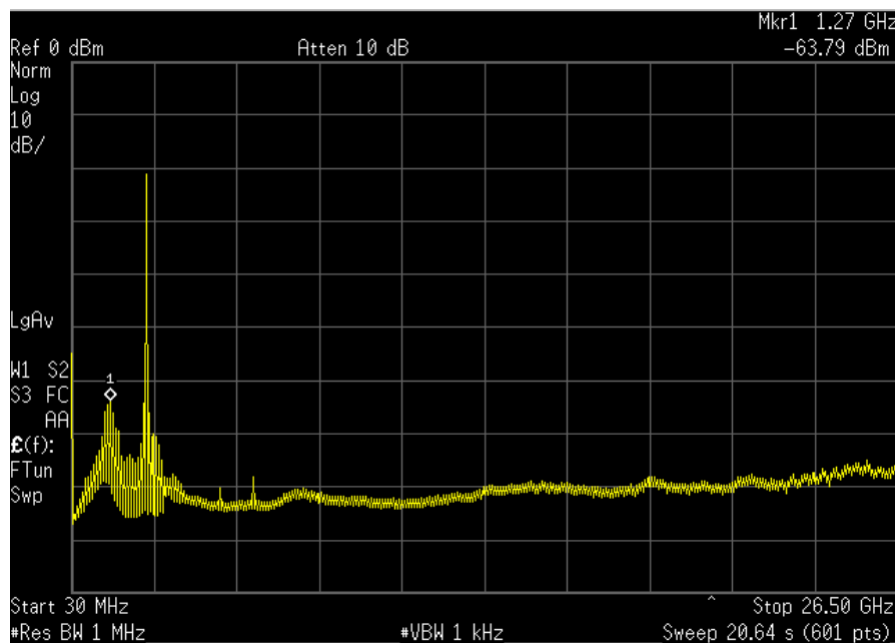

Figure A-4. Power Setting 0x0B Radiated Broadband Spectrum

Figure A-5 is a close in view of both band edges including the low band spur found in the previous figure.

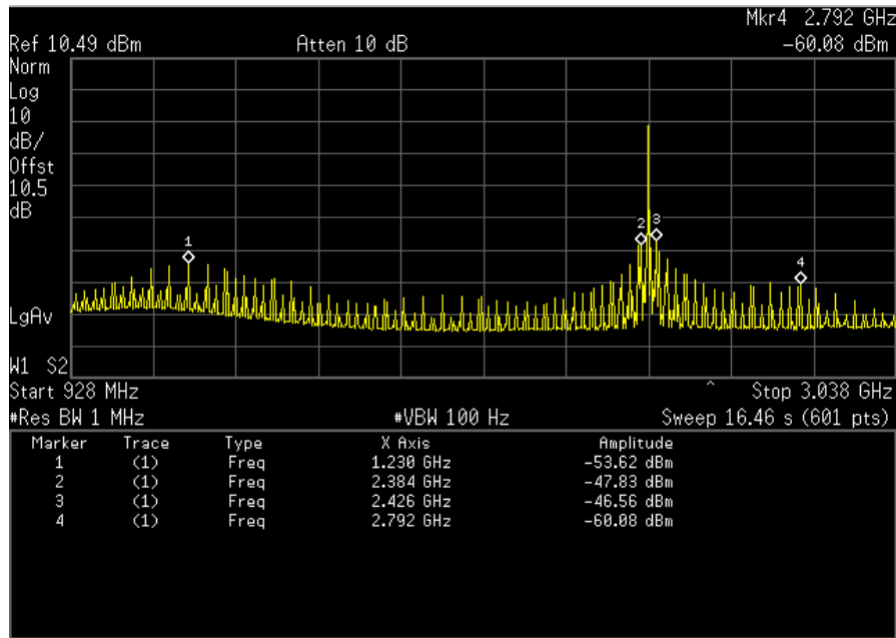

Figure A-5. Power Setting 0x0B Radiated Broad Band Spectrum

Figure A-6 is a close in view of the low band edge spur found above.

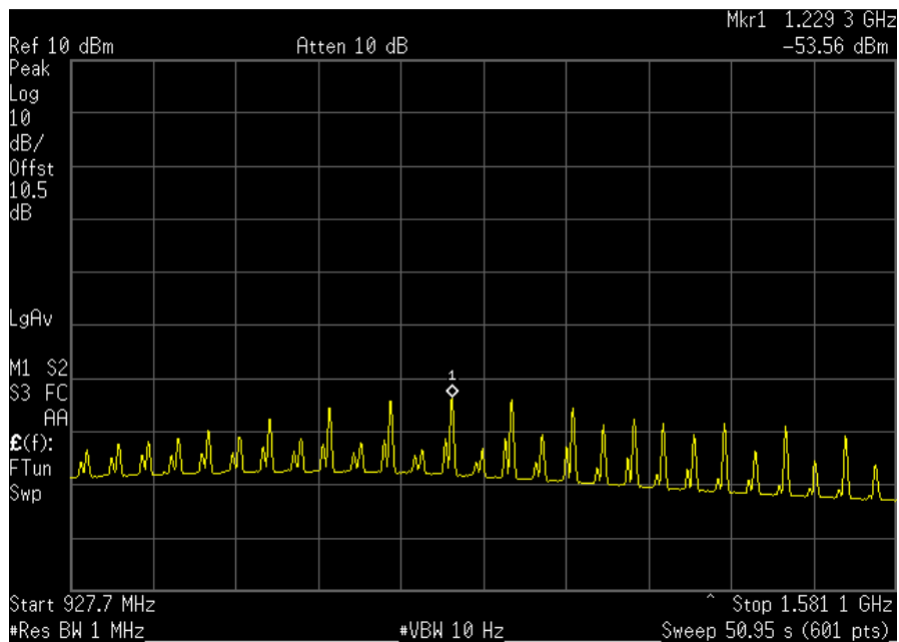

Figure A-6. Power Setting 0x0B Radiated Low Band Edge Spur

A.2.4 Radiated Spurious Band Edge – Average (LBE,HBE) Power Setting 0x0B

Figure A-7 shows a close up view of the low and high side spectrum of the spurious signals in radiated equivalent mode. This part is in Channel 11 at power setting 0B (The worst setting). The settings are the same as for the broadband measurement but with a narrow span at the band edges.

NOTE

The band edge for LBE is 2400 MHz and for HBE is 2483.5 MHz.

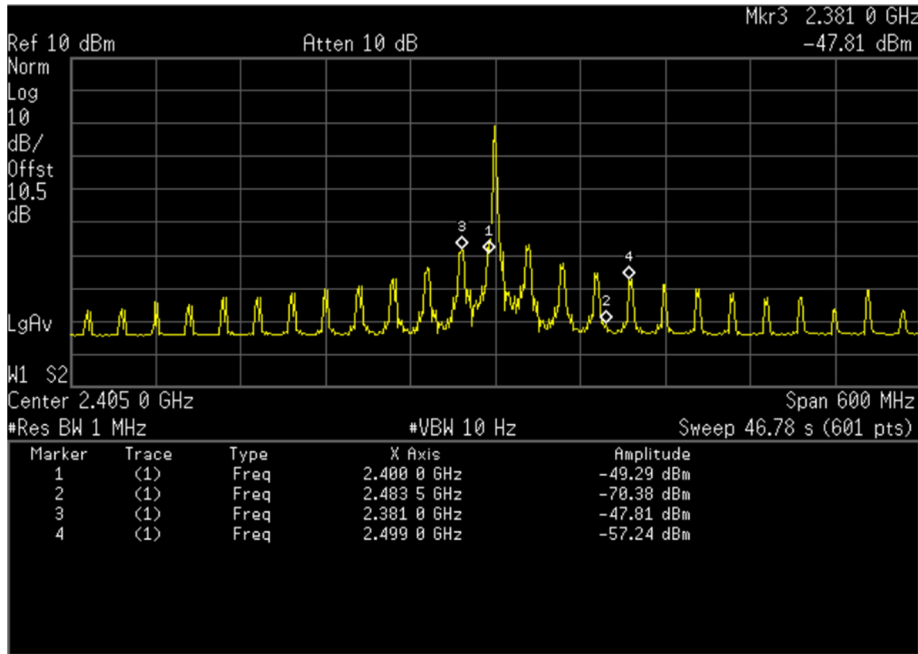

Figure A-7. Power Setting 0x0B Radiated Equivalent Spurious Low and High Side Spectrum

In Figure A-7, Markers 1 and 2 denote the band edges. Markers 3 and 4 denote band edge spurs. Observe that these very high spurs will prevent this setting for use with an external PA. As previously stated, the FCC limit for this measurement is -41.2 dBm. The DCCF can be used to improve the margin here dependant on your application. However, using the illustration that was employed above but using these numbers yields the worst case spur for this channel is $-47.8 + 25 \text{ dB PA gain} = -22.8 \text{ dBm}$. Then applying the DCCF that was derived in section 4.5 of -15.4 dB, the result is -38.2 dBm. This part would fail the conducted equivalent value of -41.2 dBm by 3 dB.

A.2.5 Radiated Spurious (Peak) – Broadband Power - Setting 0x0B

Figure A-8 shows a broadband view of the spurious signals in radiated mode during peak measurements (VBW = 1MHz) but limited to the offending spurious region.

This radiated equivalent data was taken with the part in its worst case spurious condition at power setting 0x0B.

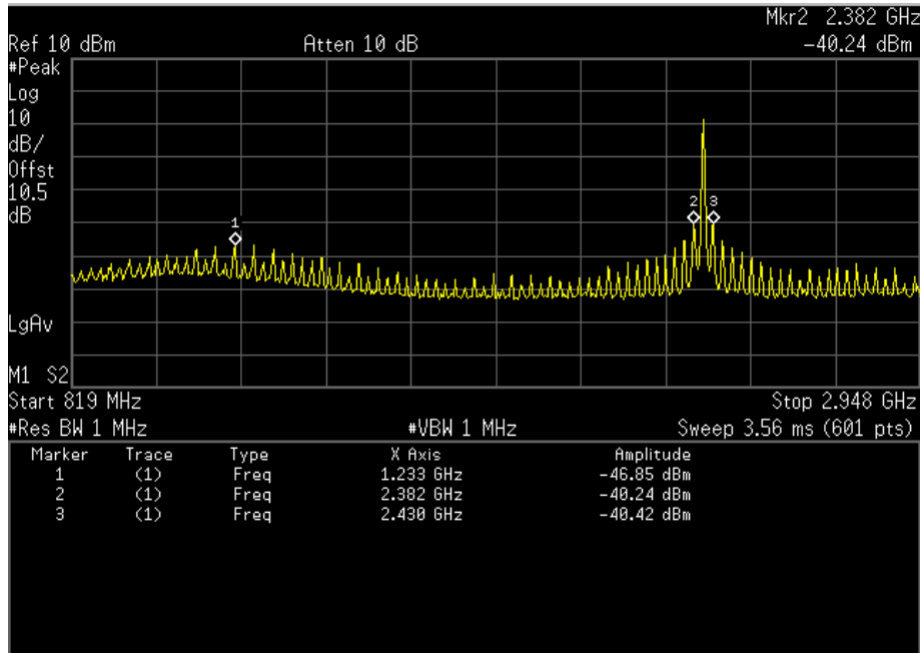

Figure A-8. Power Setting 0x0B Low Band Spur and Band Edge Side Spurs

Figure A-9 is limited to a view of the low band spur. In this mode, the spurious signals outside the operating band must be less than 20 dB above 500 uV/M at 3 meters (-21.2 dBm peak, using 1MHz VBW conducted peak). Taking the worst case spur for both cases is -40.24 dBm. Then adding 25 dB of PA gain yields -15.24 dBm which violates the FCC limit by 6 dB.

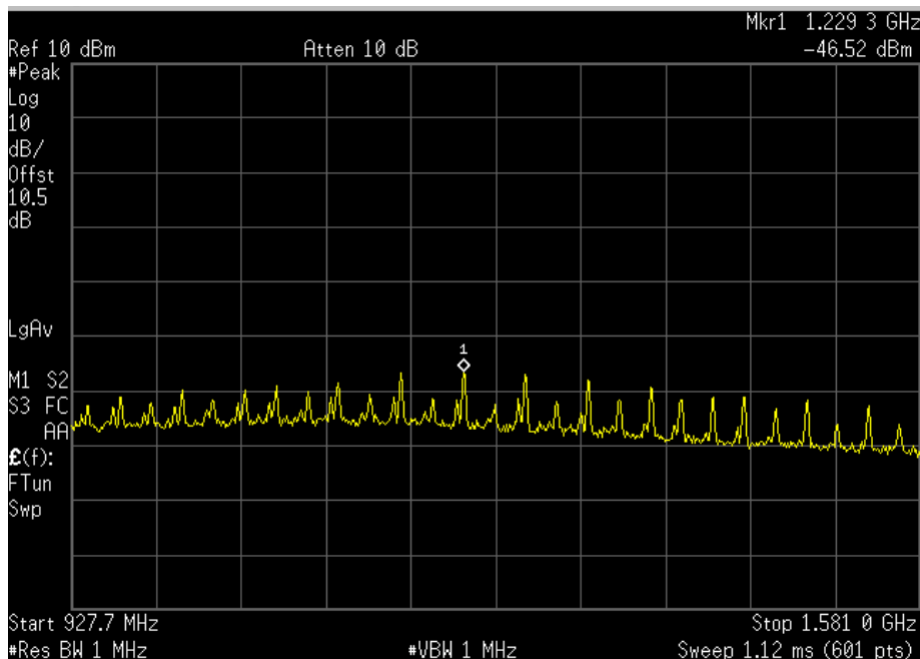

Figure A-9. Power Setting 0x0B Closer View of Low Band Spur

A.2.6 Radiated Spurious Band Edge Peak (LBE,HBE) - Power Setting 0x0B

Figure A-10 shows a close up view of the low and high side spectrum of the spurious signals in radiated mode. This part is in Channel 11 at power setting 0B (The worst setting). The settings are the same as for the broadband measurement but with a narrow span at the band edges.

NOTE

The band edge for LBE is 2400 MHz and for HBE is 2483.5 MHz.

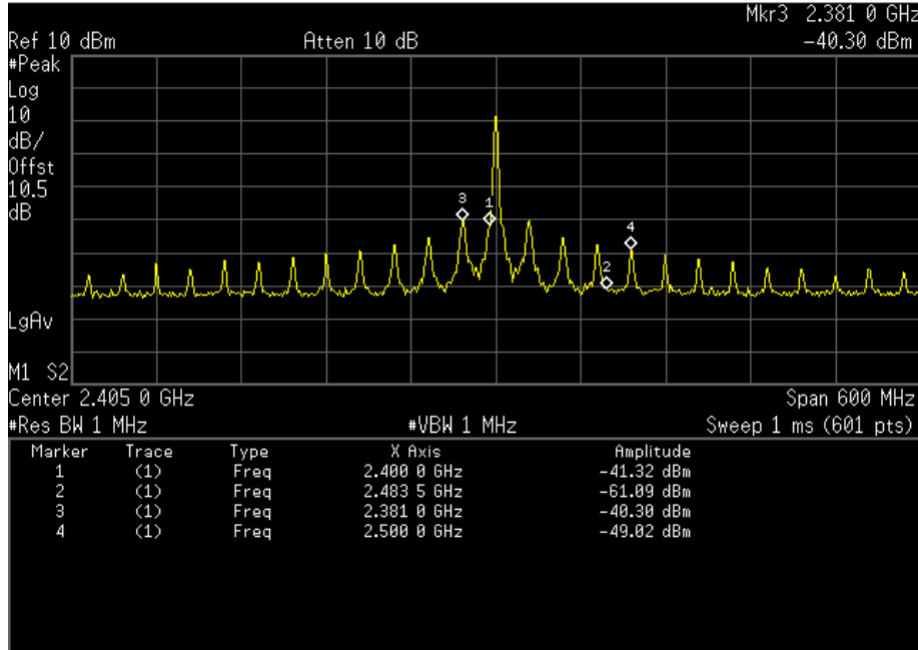

Figure A-10. Power Setting 0x0B Low Side and High Side Spurious Spectrum

In Figure A-10, Markers 1 and 2 are at the band edges. Markers 3 and 4 are the highest band edge spurs in this view. Actually, this view just emphasizes the need for using PowerLock mode to limit the use of the radio to 0C setting.

A.3 Summary

The data supplied here illustrates the need for Powerlock mode for when an external amplifier is used to boost the radio range. The single best power setting for use with an external amplifier is 0x0C for minimizing spurious content.



NOTES

How to Reach Us:

Home Page:
www.freescale.com

E-mail:
support@freescale.com

USA/Europe or Locations Not Listed:
Freescale Semiconductor
Technical Information Center, CH370
1300 N. Alma School Road
Chandler, Arizona 85224
+1-800-521-6274 or +1-480-768-2130
support@freescale.com

Europe, Middle East, and Africa:
Freescale Halbleiter Deutschland GmbH
Technical Information Center
Schatzbogen 7
81829 Muenchen, Germany
+44 1296 380 456 (English)
+46 8 52200080 (English)
+49 89 92103 559 (German)
+33 1 69 35 48 48 (French)
support@freescale.com

Japan:
Freescale Semiconductor Japan Ltd.
Headquarters
ARCO Tower 15F
1-8-1, Shimo-Meguro, Meguro-ku,
Tokyo 153-0064, Japan
0120 191014 or +81 3 5437 9125
support.japan@freescale.com

Asia/Pacific:
Freescale Semiconductor Hong Kong Ltd.
Technical Information Center
2 Dai King Street
Tai Po Industrial Estate
Tai Po, N.T., Hong Kong
+800 2666 8080
support.asia@freescale.com

For Literature Requests Only:
Freescale Semiconductor Literature Distribution Center
P.O. Box 5405
Denver, Colorado 80217
1-800-521-6274 or 303-675-2140
Fax: 303-675-2150
LDCForFreescaleSemiconductor@hibbertgroup.com

Information in this document is provided solely to enable system and software implementers to use Freescale Semiconductor products. There are no express or implied copyright licenses granted hereunder to design or fabricate any integrated circuits or integrated circuits based on the information in this document.

Freescale Semiconductor reserves the right to make changes without further notice to any products herein. Freescale Semiconductor makes no warranty, representation or guarantee regarding the suitability of its products for any particular purpose, nor does Freescale Semiconductor assume any liability arising out of the application or use of any product or circuit, and specifically disclaims any and all liability, including without limitation consequential or incidental damages. "Typical" parameters that may be provided in Freescale Semiconductor data sheets and/or specifications can and do vary in different applications and actual performance may vary over time. All operating parameters, including "Typicals", must be validated for each customer application by customer's technical experts. Freescale Semiconductor does not convey any license under its patent rights nor the rights of others. Freescale Semiconductor products are not designed, intended, or authorized for use as components in systems intended for surgical implant into the body, or other applications intended to support or sustain life, or for any other application in which the failure of the Freescale Semiconductor product could create a situation where personal injury or death may occur. Should Buyer purchase or use Freescale Semiconductor products for any such unintended or unauthorized application, Buyer shall indemnify and hold Freescale Semiconductor and its officers, employees, subsidiaries, affiliates, and distributors harmless against all claims, costs, damages, and expenses, and reasonable attorney fees arising out of, directly or indirectly, any claim of personal injury or death associated with such unintended or unauthorized use, even if such claim alleges that Freescale Semiconductor was negligent regarding the design or manufacture of the part.

Freescale™ and the Freescale logo are trademarks of Freescale Semiconductor, Inc. All other product or service names are the property of their respective owners.

© Freescale Semiconductor, Inc. 2011. All rights reserved.