

# MC1319x Coexistence

By: R. Rodriguez

## 1 Introduction

The MC1319x device is a ZigBee and IEEE<sup>®</sup> 802.15.4 Standard compliant transceiver meant to operate in the 2.4GHz Industry, Scientific and Medical (ISM) unlicensed band. This application note will address the mitigating strategies and characteristics of the MC1319x transceiver in the presence of the following interferers found in the ISM band:

- 802.15.4 ZigBee
- 802.11b/g Wireless Local Area Network (WLAN)
- 802.15 BlueTooth Wireless Personal Area Network (WPAN).

The MC1319x was characterized through both lab and radiated field testing to determine its ability to coexist in the presence of interferers located in the ISM band.

Several factors affect the coexistence performance of the MC1319x. The distance of the desired receiver to the desired transmitter and the distance of the interfering transmitter to the desired receiver both determine the channel environment. Other channel conditions include

## Contents

1 Introduction .....	1
2 Interference Rejection Characteristics .....	2
3 Channel Conditions .....	17
4 Mitigating Strategies .....	19

path loss, multi-path, fading, and polarization loss. The transmission characteristics of the devices such as carrier frequencies, channel bandwidth, transmitter duty cycle, and transmitter output power also contribute to the overall coexistence performance.

The transmitter output power of the MC1319x for all measurements and recommendations contained are based upon 0dBm (nominal). In actuality, the transceiver output power is programmable up to 4dBm. The detailed performance of the transceiver is found in the MC1319x data sheets and reference manuals.

Throughout this application note, the degree to which interferers will impact the receiver is quantified by interference rejection measurements. The test procedure for these measurements is outlined and explained in the following section. The interference rejection measurements quantify the receiver immunity to interference. The greater the interference rejection, the better the performance of the receiver in the presence of interferers. In general, a greater frequency offset from the desired carrier results in better interference rejection.

## 2 Interference Rejection Characteristics

### 2.1 Test Methodology

The transmitter of the desired carrier and the transmitter of the interferer were calibrated to a known power level at the receiver. The desired carrier was permanently set to -82dBm at the input of the receiver; the interferer was decreased from a power level of -10dBm until the packet error rate was <.5% for 1000 transmitted packets. The desired carrier frequencies were chosen to cover the ISM band:

- 2405MHz
- 2430MHz
- 2455MHz
- 2480MHz

The interference carrier was chosen to sweep across the ISM band, avoiding the desired and adjacent channel of the receiver.

An example of the interference rejection measurement is shown in [Table 1](#). The desired carrier frequency was set at 2430MHz. The interferer frequency, in this case a ZigBee interferer, was set at 2410MHz. As the power level of the interferer was reduced, the packet error rate improved until it met the threshold criteria of <.5% for 1000 packets. Since the power level of the interferer was -32dBm at the threshold point, the interference rejection is calculated to be 50dB.

**Table 1. Interference Rejection Example Measurement**

Desired Frequency 2430MHz	Interferer Frequency 2410MHz	Packet Error Rate (%)
Power Level (dBm)		
-82	-10	100
-82	-11	100
-82	-12	100
-82	-13	100
-82	-14	100
-82	-15	100
-82	-16	100
-82	-17	100
-82	-18	100
-82	-19	100
-82	-20	100
-82	-21	100
-82	-22	100
-82	-23	100
-82	-24	100
-82	-25	100
-82	-26	100
-82	-27	98.0
-82	-28	87.7
-82	-29	49.6
-82	-30	7.5
-82	-31	1.3
-82	-32	.2

The 50dB interference rejection may be translated to a physical reality by applying the following path loss formula:

$$L = 20\text{Log}(f)+20\text{Log}(d)+32.44$$

Where:

- L is the path loss in dB
- f is the frequency in MHz
- d is the distance in km

The link budget is calculated as follows:

$$L = P_t + G_t - P_r + G_r - M$$

Where:

- L is the path loss in dB
- $P_t$  is the transmit power in dBm
- $G_t$  is the transmit antenna gain in dBi
- $P_r$  is the receiver sensitivity in dBm
- $G_r$  is the receive antenna gain in dBi
- M is the link margin in dB

For simplicity, assume that both the desired and interfering transmitters have  $P_t = 0\text{dBm}$  and  $G_t = 0\text{dBi}$ .

If the transmitter is placed at 400 feet from the receiver, the receiver will have  $-82\text{dBm}$  from the transmitter. The 50dB interference rejection translates to  $-32\text{dBm}$  power from the interferer, which results in a distance of 1.5 feet from the receiver as shown in [Figure 1](#).

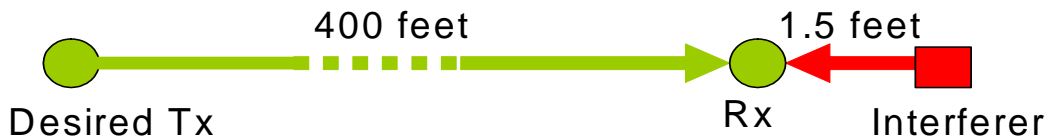

**Figure 1. Interferer at 1.5 Feet Calculated Distance**

If the intended transmitter is placed closer to the receiver, the receiver will tolerate the interfering transmitter to be moved closer as well. For example, if the intended transmitter is at 40 feet instead of 400 feet, then the interferer may be as close as 1.5 inches to the receiver as shown in [Figure 2](#).



**Figure 2. Interferer at 1.5 Inches Calculated Distance**

There are countless example distances. The results for this 50dB interference rejection are shown in Figure 3.

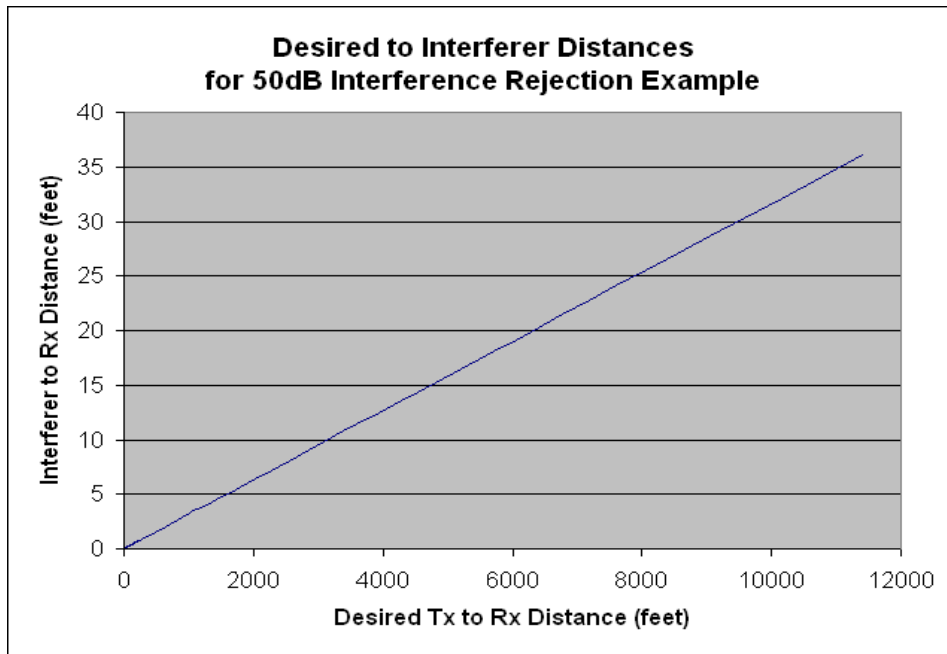

Figure 3. Interferer Distances for 50dB Interference Rejection

## 2.2 ZigBee Interferers

The MC1319x 802.15.4 compliant transceiver supports 250kbps O-QPSK data in 5MHz channels. The transceiver operates in 16 channels over the entire ISM band. The modulated spectrum is shown in Figure 4.

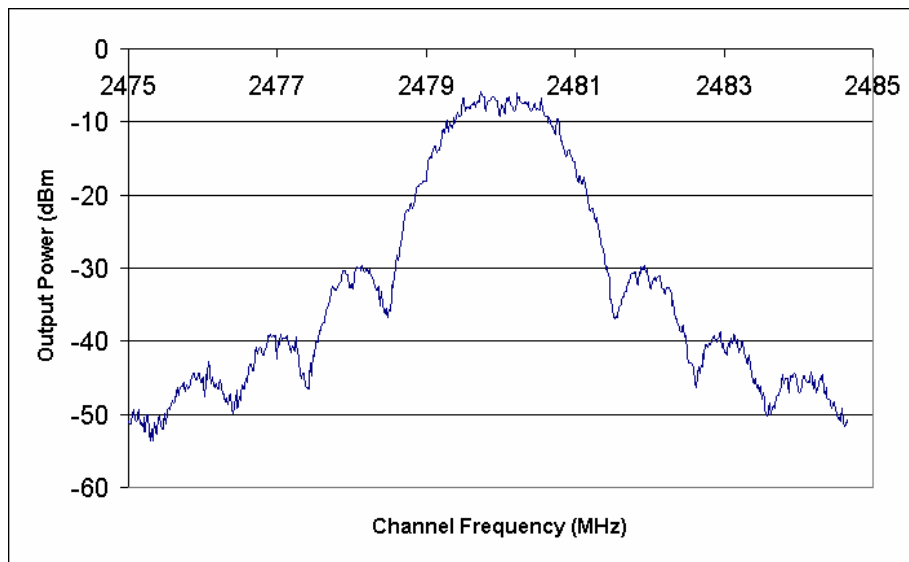

Figure 4. Modulated ZigBee Spectrum

The interference rejection of the MC1319x receiver was characterized using a ZigBee interferer. The interference rejection measurements were performed conductively in order that other channel conditions such as multi-path, fading, and polarization loss could be effectively eliminated. These channel conditions will be addressed later in this application note. The transmitter duty cycle for the interferer was set to 100%, which is an extremely conservative assumption. Most ZigBee applications are meant to operate at extremely low duty cycles. The interference rejection measurements were performed as explained in the previous section.

### NOTE

All interference measurements presented in this section assumed the receiver was set to receive a calibrated signal of -82dBm, as was defined in the 802.15.4 standard for adjacent and alternate channel rejection testing. This was done in order to remain consistent in all measurement results presented. All measurements were done on matching circuitry shown in Figure 5.

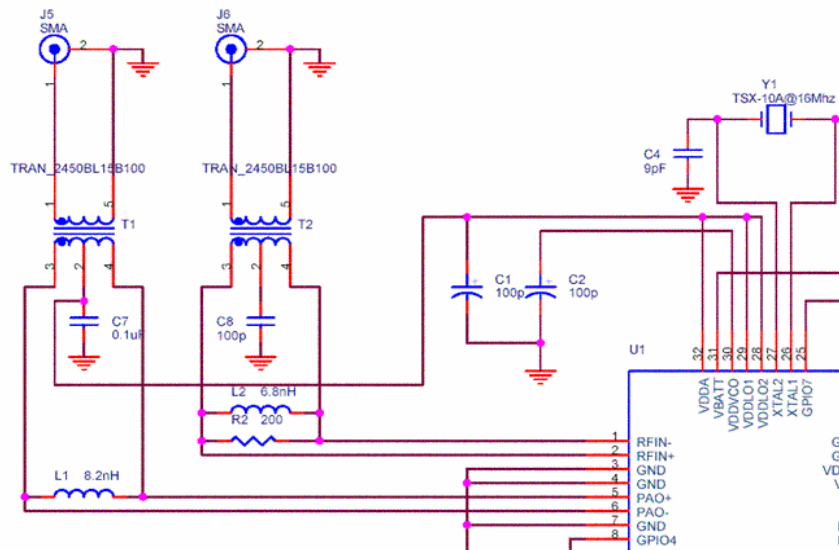

Figure 5. Matching Circuitry

Figure 6, Figure 7, Figure 8, and Figure 9 capture the results of the interference rejection measurements with a ZigBee interferer swept across the 16 ZigBee channels (2405MHz to 2480MHz in 5MHz increments).

The interferer was swept to avoid the desired and adjacent channels of the receiver. As expected, a larger frequency offset from the desired frequency to the interferer frequency resulted in more interference.

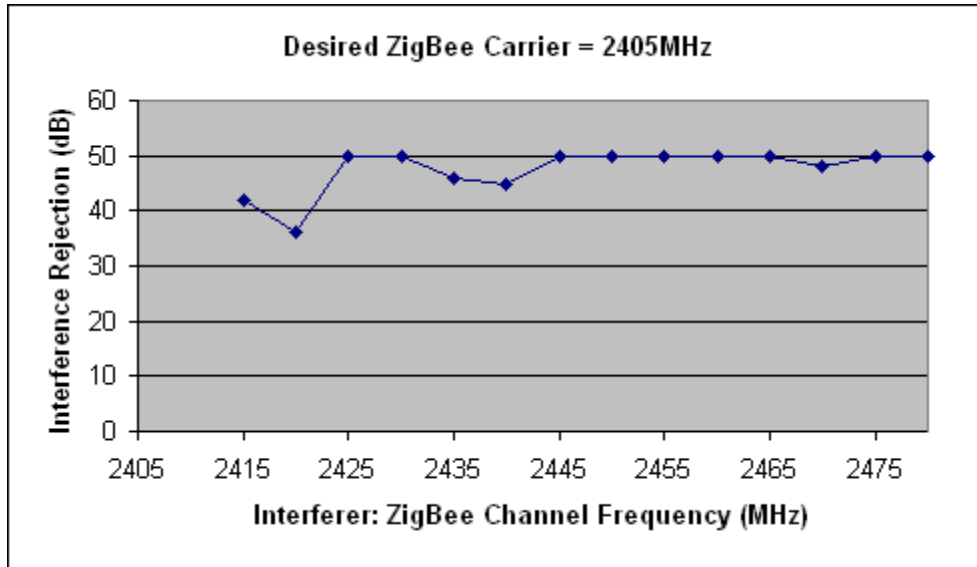

Figure 6. Desired ZigBee Carrier = 2405MHz (Zigbee Channel Interferer)

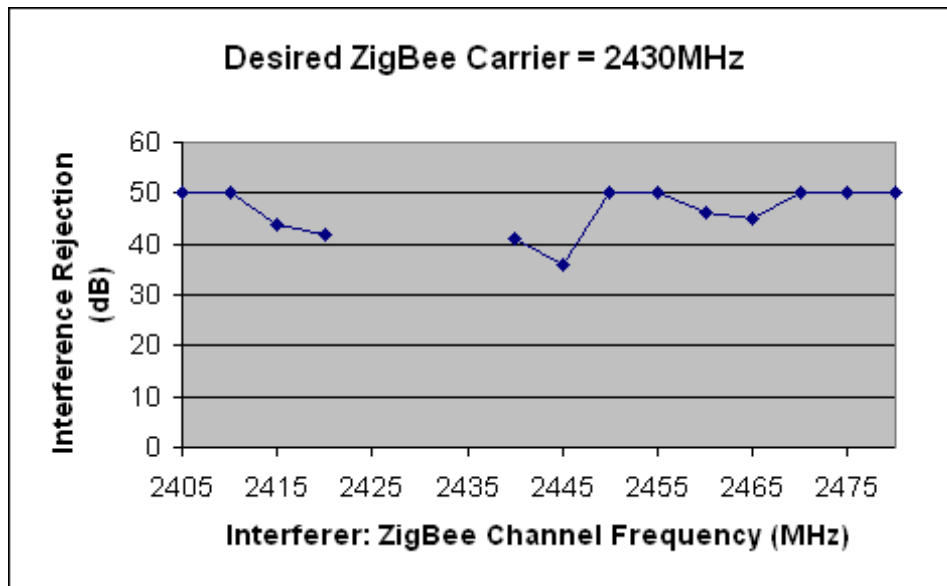

Figure 7. Desired ZigBee Carrier = 2430MHz (Zigbee Channel Interferer)

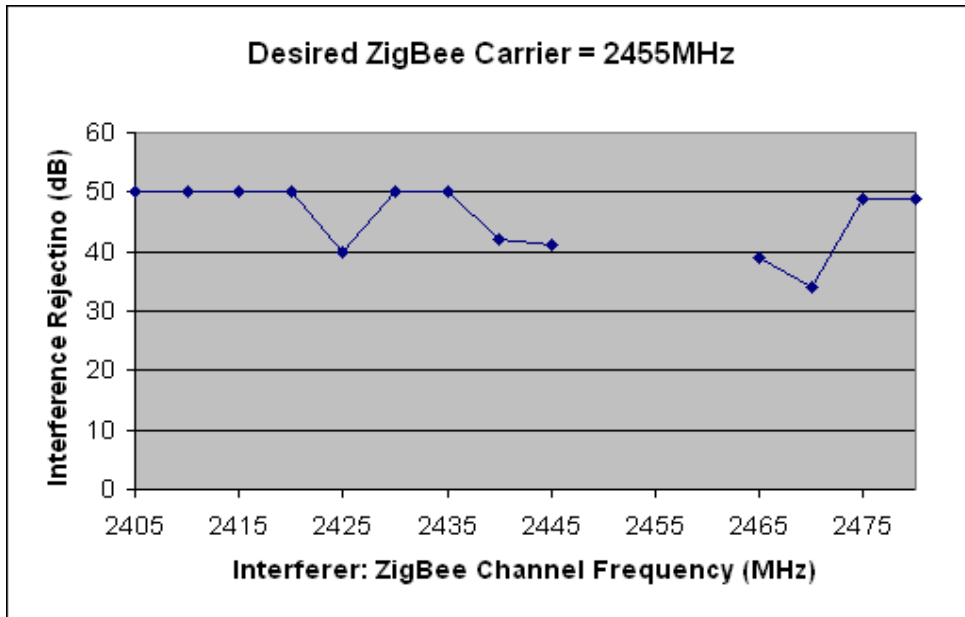

Figure 8. Desired ZigBee Carrier = 2455MHz (Zigbee Channel Interferer)

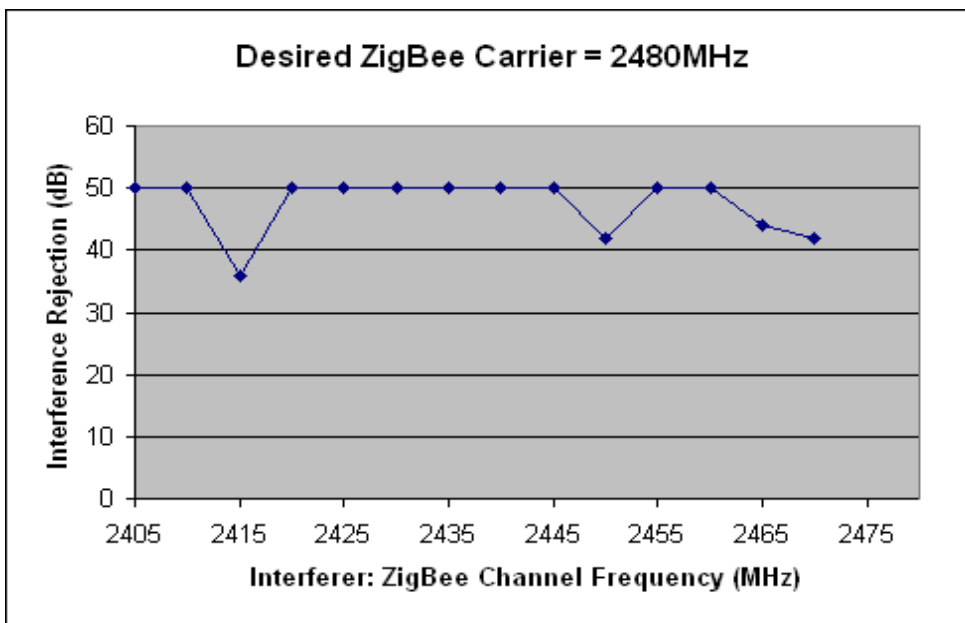

Figure 9. Desired ZigBee Carrier = 2405MHz (Zigbee Channel Interferer)



## 2.3 WLAN Interferers

The same test procedure that was used with ZigBee interferers was repeated for WLAN interferers. The WLAN signal has a 15MHz bandwidth with a throughput of up to 11Mbps. The WLAN transmitters tend to have larger and randomly varying duty cycles. The transmitter is on only when a file is transferred, and then it is on almost continuously in order to receive an acknowledgment from a client on the network. The WLAN receiver, on the other hand, transmits extremely short acknowledgment packets and has a considerably smaller duty cycle. For simplicity, the WLAN transmitter used for the measurements in this section was assumed to be periodic in nature.

Figure 10, Figure 11, Figure 12, and Figure 13 show the results of the interference rejection measurements swept over the following Zigbee carrier frequencies:

- 2405MHz
- 2430MHz
- 2455MHz
- 2480MHz

The WLAN interferer was swept across the 15 WLAN channels, while avoiding the desired ZigBee channel by +/-12MHz of the nearest WLAN channel. The 15 WLAN channels are 2412MHz to 2482MHz in 5MHz intervals.

The data shown in Figure 10, Figure 11, Figure 12, and in Figure 13 is for the matching network as shown in Figure 5. If better coexistence performance in the presence of WLAN interferers is desired, it is possible to remove the 200ohm resistor (R2 as shown in Figure 5) from the input to the receiver.

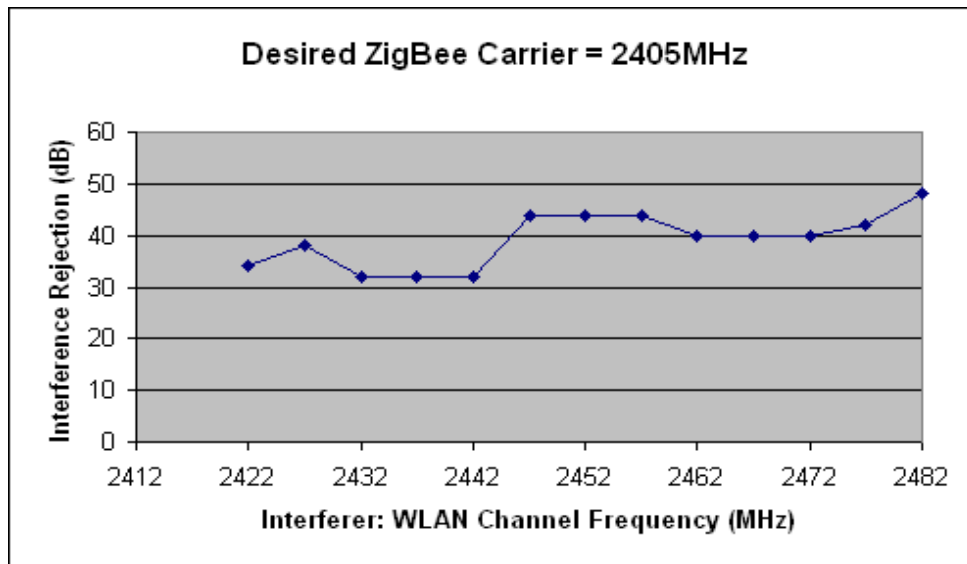

Figure 10. Desired ZigBee Carrier = 2405MHz (WLAN Interferer)

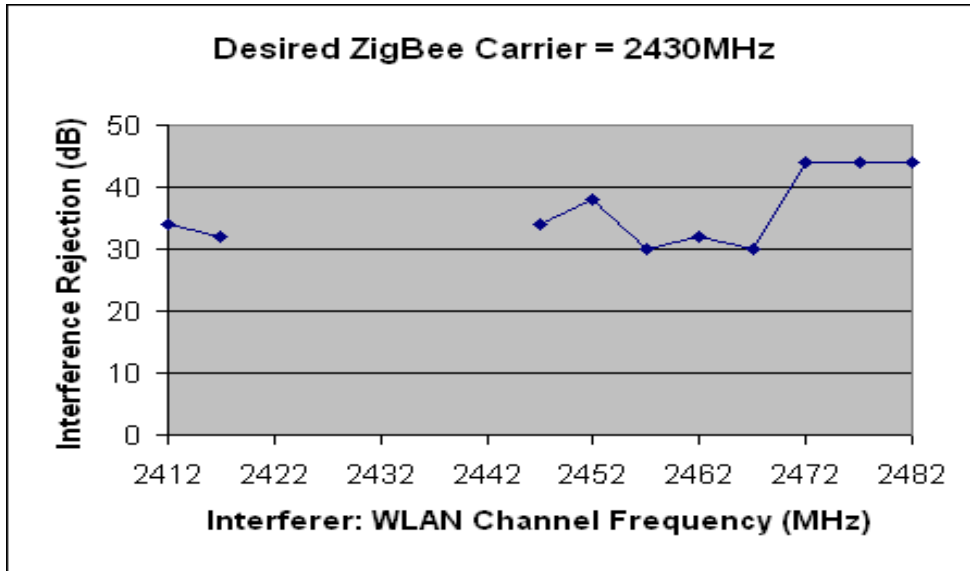

Figure 11. Desired ZigBee Carrier = 2430MHz (WLAN Interferer)

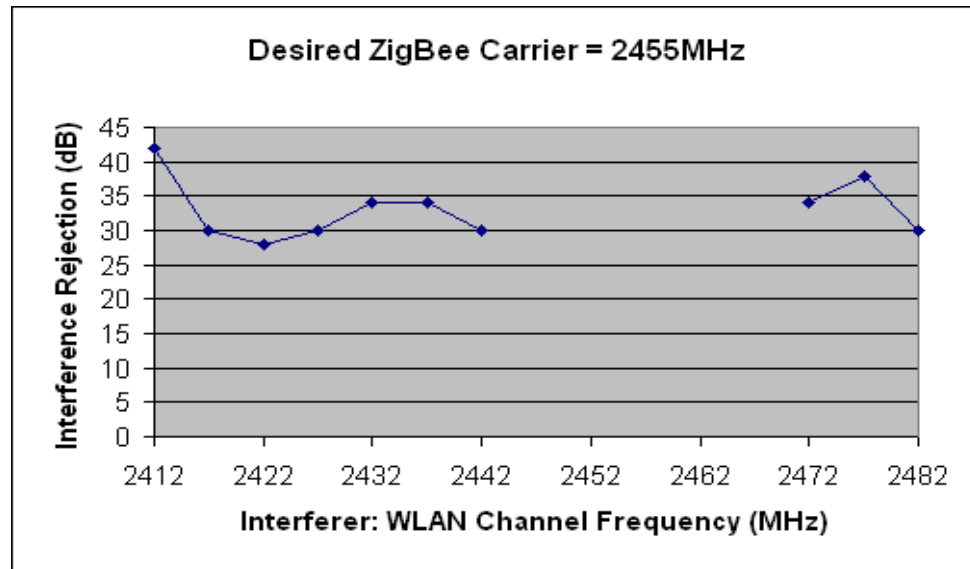

Figure 12. Desired ZigBee Carrier = 2455MHz (WLAN Interferer)

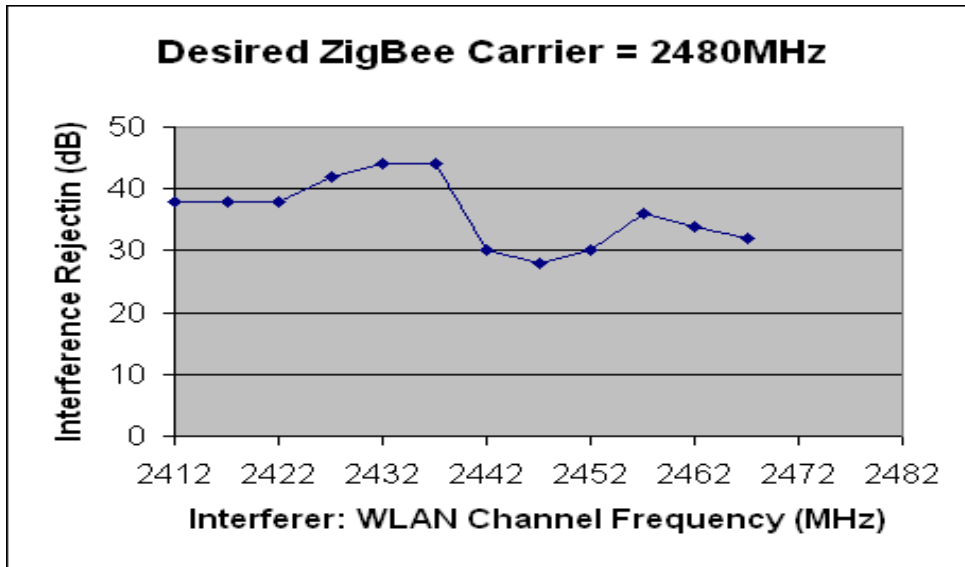

Figure 13. Desired ZigBee Carrier = 2480MHz (WLAN Interferer)

If the duty cycle of the WLAN signal is reduced, the interference rejection will improve by an average of 3dB. The results are as shown in Figure 14. The time plots for the 90% and 10% duty cycles are shown in Figure 15 and Figure 16.

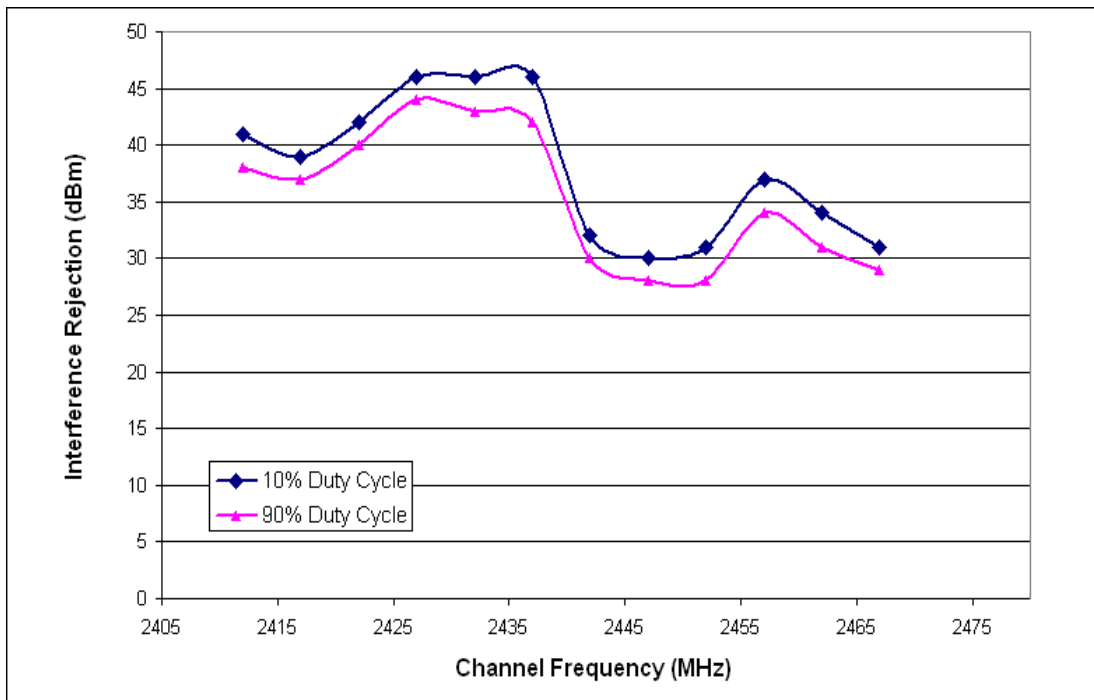
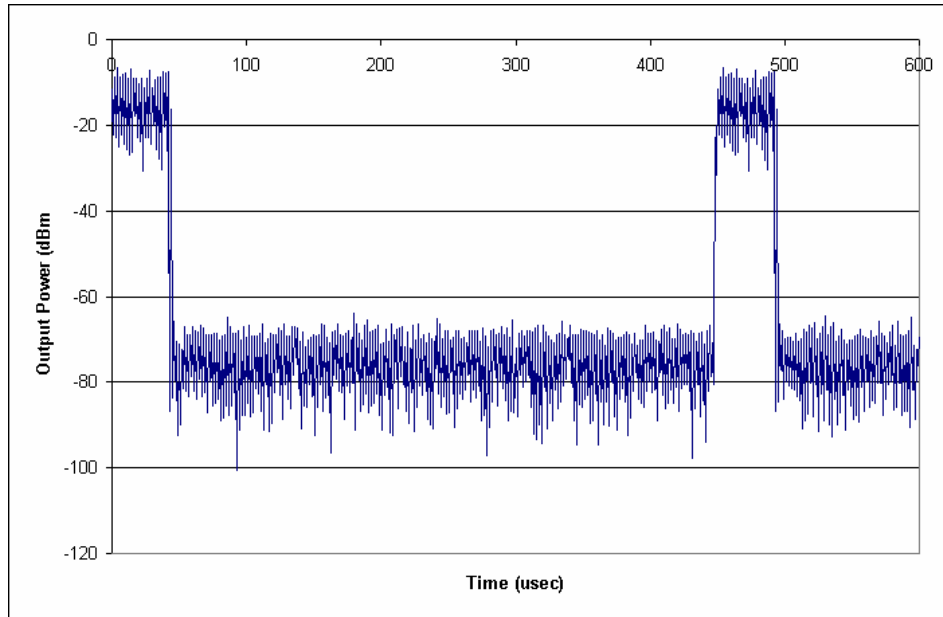
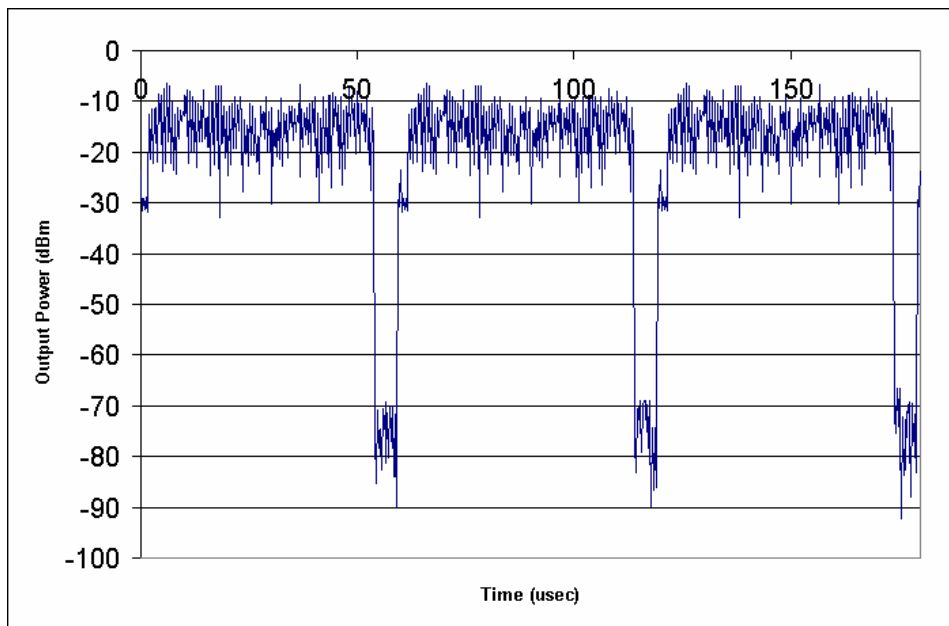

Figure 14. Interference Rejection with 90% Duty Cycle versus 10% Duty Cycle



**Figure 15. Timing of WLAN Signal at 10% Duty Cycle**



**Figure 16. Timing of WLAN Signal at 90% Duty Cycle**

WLAN has the ability to reject out of band signals by up to 35dB, and it has been determined that ZigBee will not interfere with WLAN channels. Refer to “*IEEE 802.15.4 Low Rate - Wireless Personal Area Network Coexistence Issues*” . [1]

## 2.4 BlueTooth Interferer

The BlueTooth protocol uses a narrow 1MHz band and fast frequency hopping, which allows BlueTooth transceivers to have robust performance in the presence of other ISM band signals. Conversely, fast frequency hopping also allows for better rejection of BlueTooth interferers by ZigBee transceivers. The MC1319x interference rejection measurement results with a BlueTooth interferer are shown in [Figure 17](#), [Figure 18](#), [Figure 19](#), and [Figure 20](#). The BlueTooth interferer was swept to avoid the desired and adjacent channels of the ZigBee receiver. The BlueTooth interferer was modulated with a pseudo-random pattern (PRBS9) with data high rate 1 (DH1).

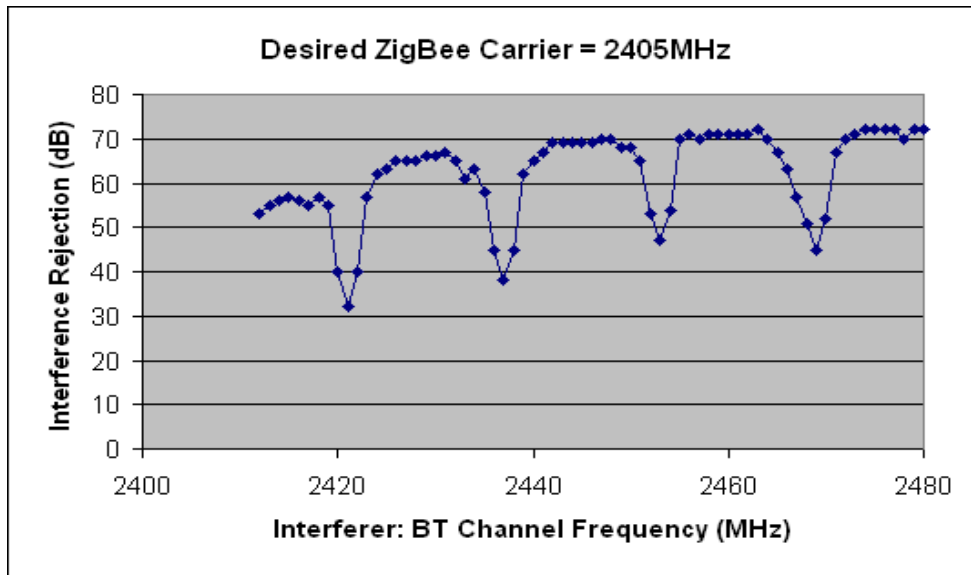

Figure 17. Desired ZigBee Carrier = 2405MHz (BlueTooth Interferer)

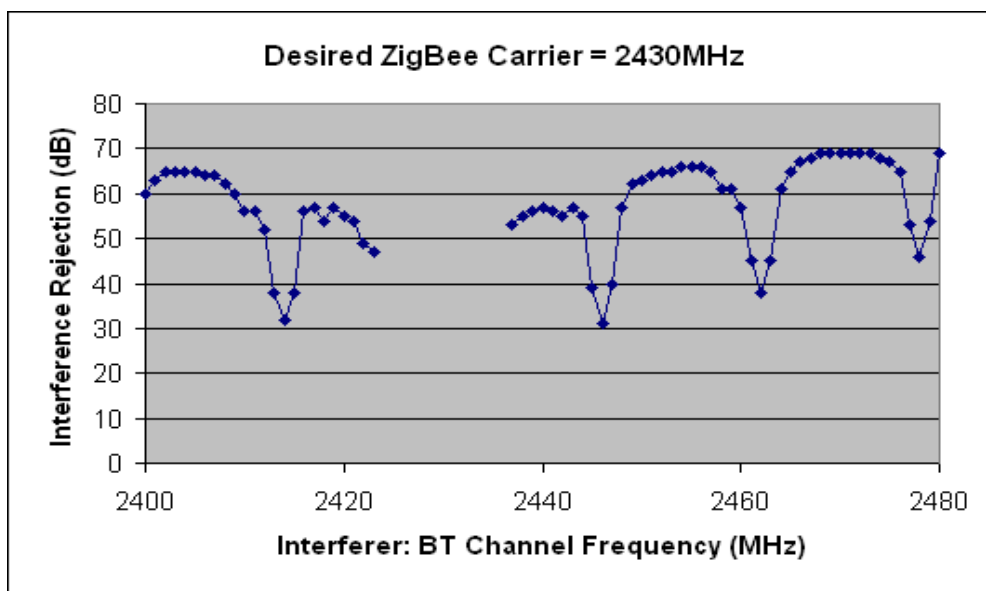
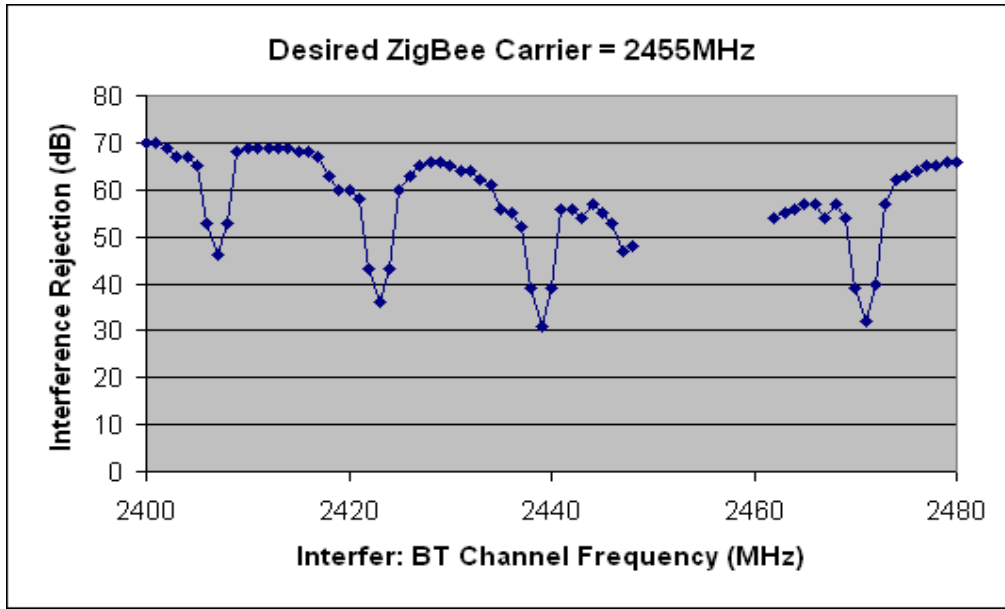
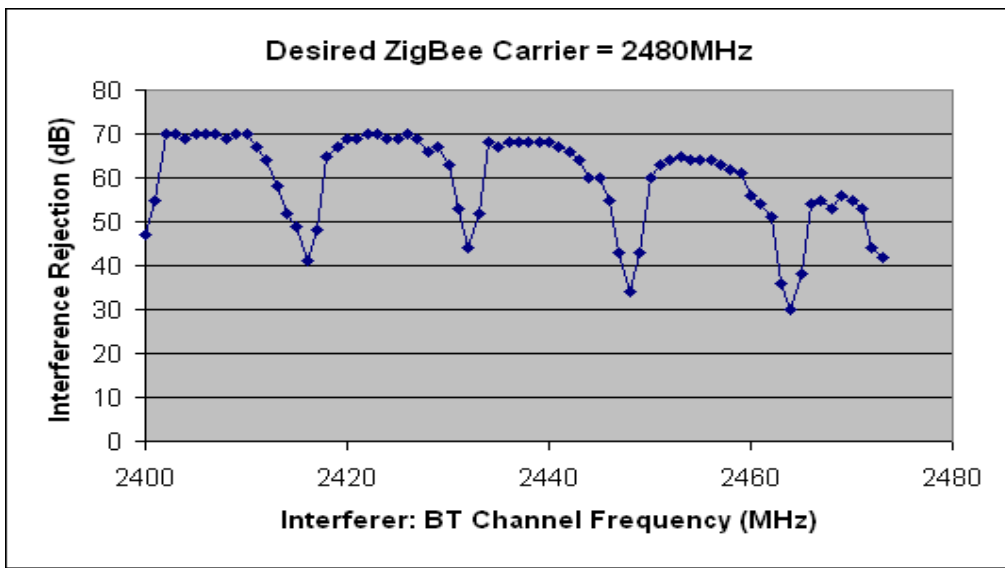

Figure 18. Desired ZigBee Carrier = 2430MHz (BlueTooth Interferer)



**Figure 19. Desired ZigBee Carrier = 2455MHz (BlueTooth Interferer)**



**Figure 20. Desired ZigBee Carrier = 2480MHz (BlueTooth Interferer)**

## 2.5 Summary of Interference Rejection Characteristics

The frequency offset, channel bandwidth, duty cycle, and transmitter output power of the desired and interferer signals all impacted coexistence performance. To improve coexistence performance, a larger frequency offset between the interferer and the desired signal should be chosen. A larger frequency offset is required for an interferer with a wider bandwidth (WLAN) than an interferer with a narrower bandwidth (ZigBee and BlueTooth). If possible, the duty cycle and transmitter output power of the interferer could be reduced to further improve coexistence performance. For example, as shown in Figure 12, there was a 3dB improvement when the duty cycle was reduced from 90% to 10%. In most applications, it is not possible to reduce or vary the output power of the interferer. Therefore, the intended receiver should be placed closer to the intended transmitter and further from the interfering transmitter.

The acceptable distances for the interferer and desired transmitter to the receiver can be translated from the interference rejection measurements. For example, the worst case interference measured for ZigBee and WLAN were 34dB and 28dB, respectively. These results are shown in Figure 21 and Figure 22. These interference rejection values can be translated to distances as shown in Section 2.1, “Test Methodology”. The acceptable distances are plotted in Figure 23 and Figure 24. For these plots it was assumed the interferer output was 0dBm for ZigBee and +15dBm for WLAN.

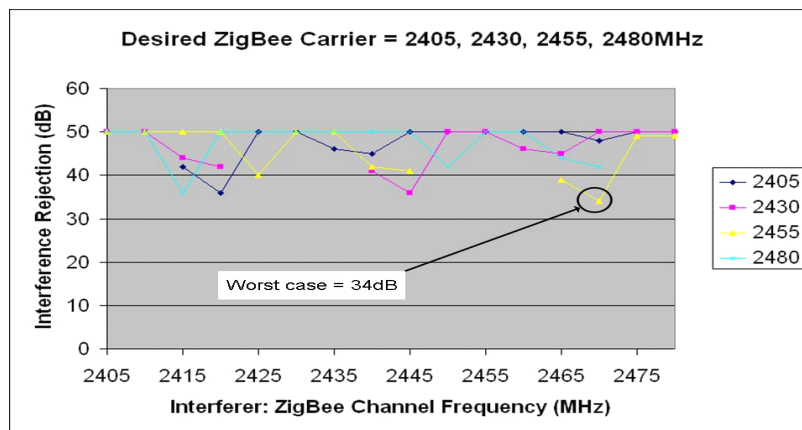

Figure 21. Worst Case Results (Zigbee Interferers)

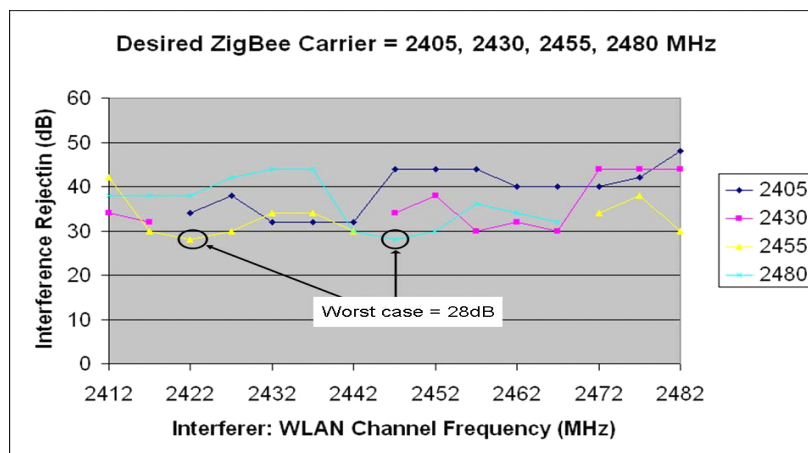
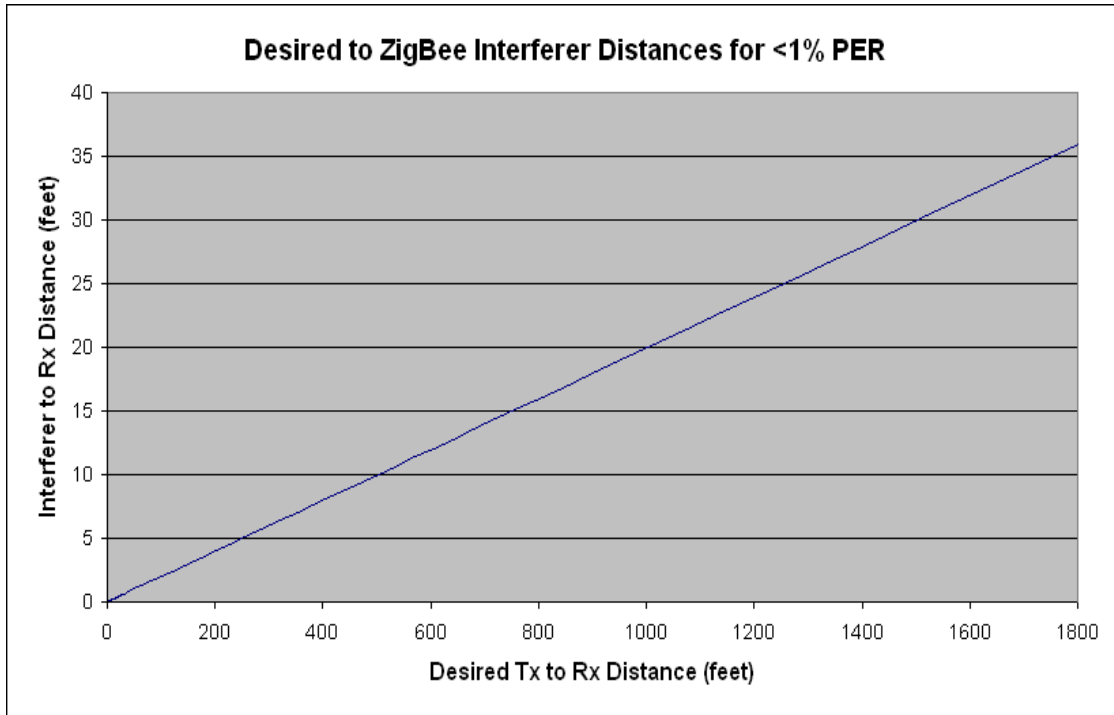
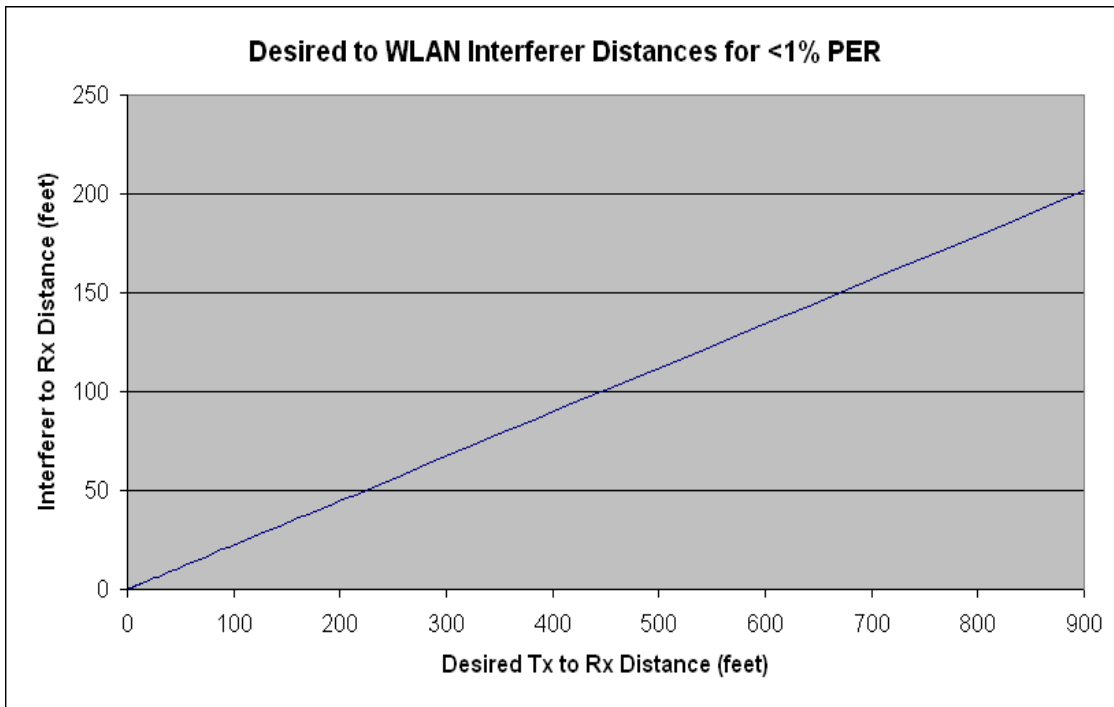

Figure 22. Worst Case Results (WLAN Interferers)



**Figure 23. ZigBee Interferer Distance**



**Figure 24. WLAN Interferer Distance**



### 3 Channel Conditions

Channel conditions that were effectively eliminated in the conducted test as described in previous sections, are addressed here to more closely approximate actual conditions. The same test methodology described in Section 2.1, “Test Methodology”, to measure interference channel rejection was used with the following exceptions:

- Transmitter output power was not fixed to -82dBm at the receiver
- All tests were radiated
- MAC layer software was used instead of PHY layer software

The threshold criteria was based on throughput rather than PER, since MAC layer software allows for up to three retransmissions of error packets. All measurements were performed in a hallway of a commercial building with the test set-up as shown in Figure 25.



Figure 25. Test Conditions

When the transmitter was placed 50 feet from the receiver and the interferer was placed 1 foot away from the receiver, for frequencies > 25MHz from carrier, 100% of packets were received. When the interferer was placed at frequencies < 25MHz from carrier in the same scenario, the interference rejection degraded. The data for >25MHz and <25MHz offset are plotted in Figure 26. Therefore, to improve immunity to interferers, it is better to place the desired carrier more than 25MHz away from interferer.

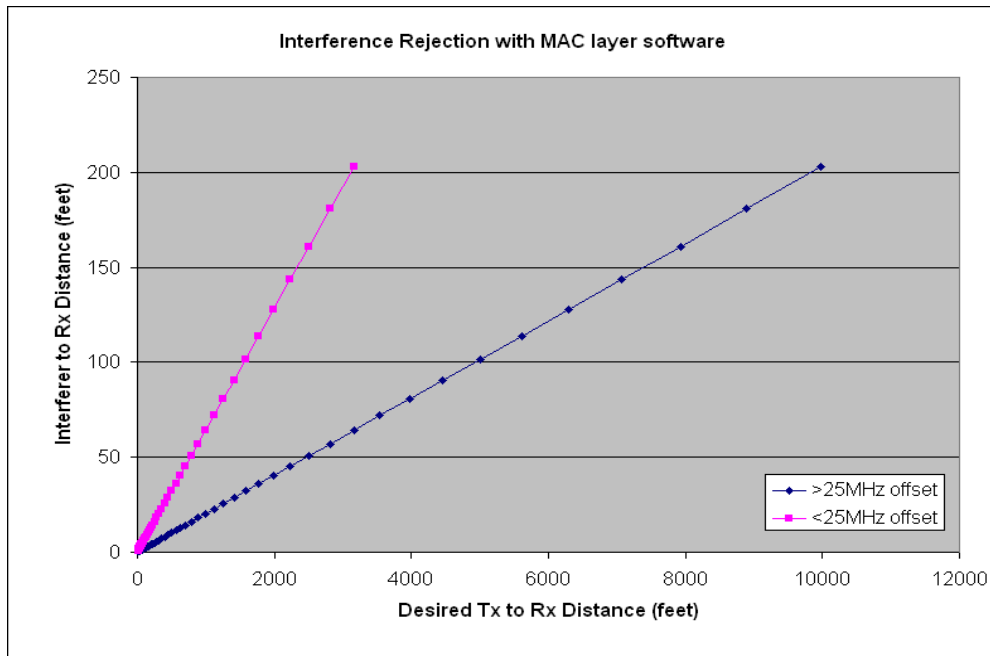

Figure 26. >25MHz and <25MHz Offset Plot

## 4 Mitigating Strategies

In order to reduce interference, an appropriate ZigBee channel should be selected to avoid interference. The ZigBee receiver should be placed at a sufficient distance away from the interferer or be placed closer to the intended transmitter. The 802.15.4 standard addresses coexistence issues by implementing channel alignment, channel selection, clear channel assessment, and LQI. These mitigating strategies are explained in detail in “*IEEE 802.15.4 Low-Rate Wireless Personal Area Networks: Enabling Wireless Sensor Networks (April 2003)*” [2] These same mitigating strategies are summarized in the following list:

1. Channel alignment:  
The upper layers of the software stack perform dynamic channel selection, either at network initialization or in response to channel impairment.
2. Channel selection:  
The PAN coordinator scans all channels to identify and join a suitable PAN, rather than create a second PAN. This minimizes number of PANS existing in a band, reducing potential interference to other services. If interference appears on the channel, the upper layers of the PAN coordinator execute a dynamic channel selection algorithm to select a new channel.
3. Clear Channel Assessment (CCA):  
If the channel is occupied by any device, regardless of the communication protocol, CCA allows for transmission back-off.
4. Link Quality Indicator (LQI):  
LQI can be used to detect channel impairment on a packet-by-packet basis, providing “real time” information to the upper layers of the channel condition.

## References

1. Howitt, I. and Gutierrez, J.A. *Wireless Communication and Networking*, Volume 3, March 2003, “*IEEE 802.15.4 Low Rate - Wireless Personal Are Network Coexistence Issues*”
2. Gutierrez, J.A., Callaway, E.H. Barrett, R. *Standards Information Network IEEE Press*, N.Y., 2003, *IEEE 802.15.4 Low-Rate Wireless Personal Are Networks: Enabling Wireless Sensor Networks*



**NOTES**

**How to Reach Us:**

**Home Page:**  
www.freescale.com

**E-mail:**  
support@freescale.com

**USA/Europe or Locations Not Listed:**  
Freescale Semiconductor  
Technical Information Center, CH370  
1300 N. Alma School Road  
Chandler, Arizona 85224  
+1-800-521-6274 or +1-480-768-2130  
support@freescale.com

**Europe, Middle East, and Africa:**  
Freescale Halbleiter Deutschland GmbH  
Technical Information Center  
Schatzbogen 7  
81829 Muenchen, Germany  
+44 1296 380 456 (English)  
+46 8 52200080 (English)  
+49 89 92103 559 (German)  
+33 1 69 35 48 48 (French)  
support@freescale.com

**Japan:**  
Freescale Semiconductor Japan Ltd.  
Headquarters  
ARCO Tower 15F  
1-8-1, Shimo-Meguro, Meguro-ku,  
Tokyo 153-0064, Japan  
0120 191014 or +81 3 5437 9125  
support.japan@freescale.com

**Asia/Pacific:**  
Freescale Semiconductor Hong Kong Ltd.  
Technical Information Center  
2 Dai King Street  
Tai Po Industrial Estate  
Tai Po, N.T., Hong Kong  
+800 2666 8080  
support.asia@freescale.com

**For Literature Requests Only:**  
Freescale Semiconductor Literature Distribution Center  
P.O. Box 5405  
Denver, Colorado 80217  
1-800-521-6274 or 303-675-2140  
Fax: 303-675-2150  
LDCForFreescaleSemiconductor@hibbertgroup.com

Information in this document is provided solely to enable system and software implementers to use Freescale Semiconductor products. There are no express or implied copyright licenses granted hereunder to design or fabricate any integrated circuits or integrated circuits based on the information in this document.

Freescale Semiconductor reserves the right to make changes without further notice to any products herein. Freescale Semiconductor makes no warranty, representation or guarantee regarding the suitability of its products for any particular purpose, nor does Freescale Semiconductor assume any liability arising out of the application or use of any product or circuit, and specifically disclaims any and all liability, including without limitation consequential or incidental damages. "Typical" parameters that may be provided in Freescale Semiconductor data sheets and/or specifications can and do vary in different applications and actual performance may vary over time. All operating parameters, including "Typicals", must be validated for each customer application by customer's technical experts. Freescale Semiconductor does not convey any license under its patent rights nor the rights of others. Freescale Semiconductor products are not designed, intended, or authorized for use as components in systems intended for surgical implant into the body, or other applications intended to support or sustain life, or for any other application in which the failure of the Freescale Semiconductor product could create a situation where personal injury or death may occur. Should Buyer purchase or use Freescale Semiconductor products for any such unintended or unauthorized application, Buyer shall indemnify and hold Freescale Semiconductor and its officers, employees, subsidiaries, affiliates, and distributors harmless against all claims, costs, damages, and expenses, and reasonable attorney fees arising out of, directly or indirectly, any claim of personal injury or death associated with such unintended or unauthorized use, even if such claim alleges that Freescale Semiconductor was negligent regarding the design or manufacture of the part.

Freescale™ and the Freescale logo are trademarks of Freescale Semiconductor, Inc. All other product or service names are the property of their respective owners.

© Freescale Semiconductor, Inc. 2005. All rights reserved.