



# RF Power Field Effect Transistor

## N-Channel Enhancement-Mode Lateral MOSFET

Designed for W-CDMA base station applications with frequencies from 2110 to 2170 MHz. Suitable for FM, TDMA, CDMA and multicarrier amplifier applications. To be used in Class AB for PCN-PCS/cellular radio and WLL applications.

- Typical W-CDMA Performance: -45 dBc ACPR, 2170 MHz, 28 Volts, 5 MHz Offset/4.096 MHz BW, 15 DTCH  
 Output Power — 2.1 Watts  
 Power Gain — 13.5 dB  
 Efficiency — 21%
- Capable of Handling 10:1 VSWR @ 28 Vdc, 2140 MHz, 10 Watts CW Output Power

### Features

- High Gain, High Efficiency and High Linearity
- Integrated ESD Protection
- Designed for Maximum Gain and Insertion Phase Flatness
- Excellent Thermal Stability
- Characterized with Series Equivalent Large-Signal Impedance Parameters
- Low Gold Plating Thickness on Leads. L Suffix Indicates 40μ" Nominal.
- RoHS Compliant.
- In Tape and Reel. R1 Suffix = 500 Units per 32 mm, 13 Inch Reel.

**MRF21010LSR1**

**2110-2170 MHz, 10 W, 28 V  
 LATERAL N-CHANNEL  
 BROADBAND  
 RF POWER MOSFET**

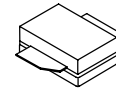

**CASE 360C-05, STYLE 1  
 NI-360S**

LIFETIME BUY

LAST ORDER 1 JUL 11 LAST SHIP 30 JUN 12

**Table 1. Maximum Ratings**

Rating	Symbol	Value	Unit
Drain-Source Voltage	V <sub>DSS</sub>	-0.5, +65	Vdc
Gate-Source Voltage	V <sub>GS</sub>	- 0.5, +15	Vdc
Total Device Dissipation @ T <sub>C</sub> = 25°C Derate above 25°C	P <sub>D</sub>	43.75 0.25	W W/°C
Storage Temperature Range	T <sub>stg</sub>	- 65 to +150	°C
Case Operating Temperature	T <sub>C</sub>	150	°C
Operating Junction Temperature	T <sub>J</sub>	200	°C

**Table 2. Thermal Characteristics**

Characteristic	Symbol	Value	Unit
Thermal Resistance, Junction to Case	R <sub>θJC</sub>	5.5	°C/W

**Table 3. ESD Protection Characteristics**

Test Conditions	Class
Human Body Model	1 (Minimum)
Machine Model	M1 (Minimum)

**Table 4. Electrical Characteristics** ( $T_C = 25^\circ\text{C}$  unless otherwise noted)

Characteristic	Symbol	Min	Typ	Max	Unit
<b>Off Characteristics</b>					
Drain-Source Breakdown Voltage ( $V_{GS} = 0\text{ Vdc}$ , $I_D = 10\ \mu\text{A}$ )	$V_{(BR)DSS}$	65	—	—	Vdc
Zero Gate Voltage Drain Current ( $V_{DS} = 28\text{ Vdc}$ , $V_{GS} = 0\text{ Vdc}$ )	$I_{DSS}$	—	—	10	$\mu\text{Adc}$
Gate-Source Leakage Current ( $V_{GS} = 5\text{ Vdc}$ , $V_{DS} = 0\text{ Vdc}$ )	$I_{GSS}$	—	—	1	$\mu\text{Adc}$
<b>On Characteristics</b>					
Gate Threshold Voltage ( $V_{DS} = 10\text{ V}$ , $I_D = 50\ \mu\text{A}$ )	$V_{GS(th)}$	2.5	3	4	Vdc
Gate Quiescent Voltage ( $V_{DS} = 28\text{ V}$ , $I_D = 100\text{ mA}$ )	$V_{GS(Q)}$	2.5	4	4.5	Vdc
Drain-Source On-Voltage ( $V_{GS} = 10\text{ V}$ , $I_D = 0.5\text{ A}$ )	$V_{DS(on)}$	—	0.4	0.5	Vdc
Forward Transconductance ( $V_{DS} = 10\text{ V}$ , $I_D = 1\text{ A}$ )	$g_{fs}$	—	0.95	—	S
<b>Dynamic Characteristics</b>					
Reverse Transfer Capacitance ( $V_{DS} = 28\text{ Vdc}$ , $V_{GS} = 0$ , $f = 1\text{ MHz}$ )	$C_{rss}$	—	1	—	pF
<b>Functional Tests</b> (In Freescale Test Fixture, 50 ohm system)					
Two-Tone Common Source Amplifier Power Gain ( $V_{DD} = 28\text{ Vdc}$ , $P_{out} = 10\text{ W PEP}$ , $I_{DQ} = 100\text{ mA}$ , $f = 2170\text{ MHz}$ , Tone Spacing = 100 KHz)	$G_{ps}$	12	13.5	—	dB
Two-Tone Drain Efficiency ( $V_{DD} = 28\text{ Vdc}$ , $P_{out} = 10\text{ W PEP}$ , $I_{DQ} = 100\text{ mA}$ , $f = 2170\text{ MHz}$ , Tone Spacing = 100 KHz)	$\eta$	31	35	—	%
Third Order Intermodulation Distortion ( $V_{DD} = 28\text{ Vdc}$ , $P_{out} = 10\text{ W PEP}$ , $I_{DQ} = 100\text{ mA}$ , $f = 2170\text{ MHz}$ , Tone Spacing = 100 KHz)	IMD	—	-35	-30	dBc
Input Return Loss ( $V_{DD} = 28\text{ Vdc}$ , $P_{out} = 10\text{ W PEP}$ , $I_{DQ} = 100\text{ mA}$ , $f = 2170\text{ MHz}$ , Tone Spacing = 100 KHz)	IRL	—	-12	-10	dB
Output Power, 1 dB Compression Point, CW ( $V_{DD} = 28\text{ Vdc}$ , $I_{DQ} = 100\text{ mA}$ , $f = 2170\text{ MHz}$ )	P1dB	—	11	—	W
Common-Source Amplifier Power Gain ( $V_{DD} = 28\text{ Vdc}$ , $P_{out} = 10\text{ W CW}$ , $I_{DQ} = 100\text{ mA}$ , $f = 2170\text{ MHz}$ )	$G_{ps}$	—	12	—	dB
Drain Efficiency ( $V_{DD} = 28\text{ Vdc}$ , $P_{out} = 10\text{ W CW}$ , $I_{DQ} = 100\text{ mA}$ , $f = 2170\text{ MHz}$ )	$\eta$	—	42	—	%

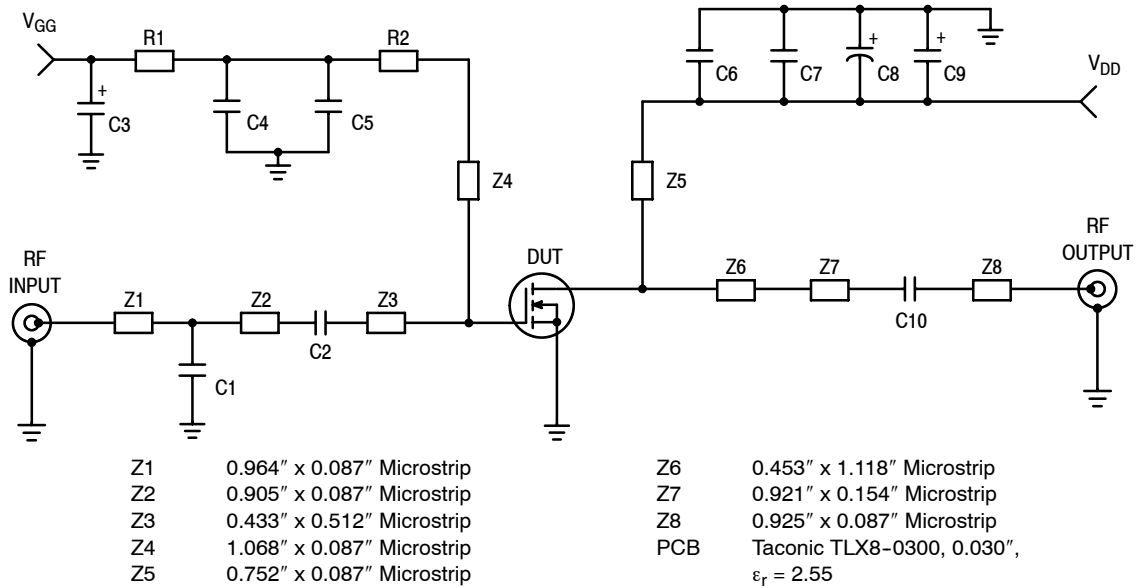
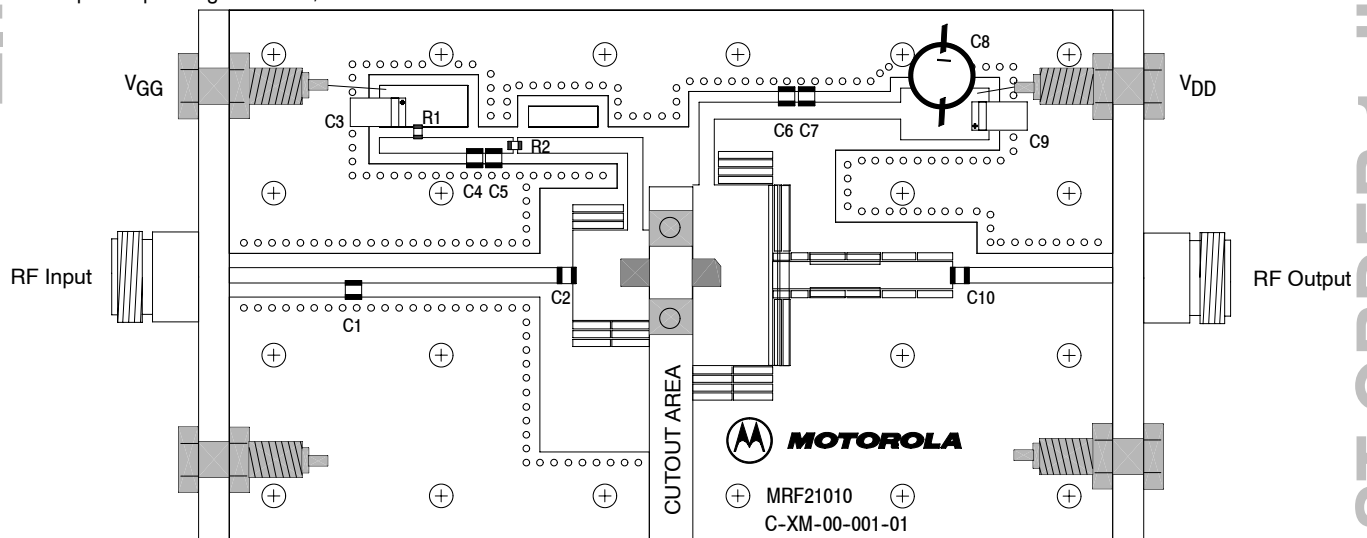

**Figure 1. MRF21010L Test Circuit Schematic**

**Table 5. MRF21010L Test Circuit Component Designations and Values**

Part	Description	Part Number	Manufacturer
C1 *	(eared) 2.2 pF Chip Capacitor	ATC100B2R2BT500XT	ATC
	(earless) 1.8 pF Chip Capacitor	ATC100B1R8BT500XT	ATC
C2	0.5 pF Chip Capacitor	ATC100B0R5BT500XT	ATC
C3, C9	10 $\mu$ F, 35 V Tantalum Chip Capacitors	T491D106K035AT	Kemet
C4, C7	1 nF Chip Capacitors	ATC100B102JT50XT	ATC
C5, C6	5.6 pF Chip Capacitors	ATC100B5R6BT500XT	ATC
C8	470 $\mu$ F, 63 V Electrolytic Capacitor	EKME630ELL471MK25S	Nippon Chemi-Con
C10	10 pF Chip Capacitor	ATC100B100GT500XT	ATC
R1	1.0 k $\Omega$ , 1/8 W Chip Resistor	CRCW08051001FKEA	Vishay
R2	12 $\Omega$ , 1/8 W Chip Resistor	CRCW080512R0FKEA	Vishay

\* Piece part depending on eared / earless version of the device.



Freescle has begun the transition of marking Printed Circuit Boards (PCBs) with the Freescle Semiconductor signature/logo. PCBs may have either Motorola or Freescle markings during the transition period. These changes will have no impact on form, fit or function of the current product.

**Figure 2. MRF21010L Test Circuit Component Layout**

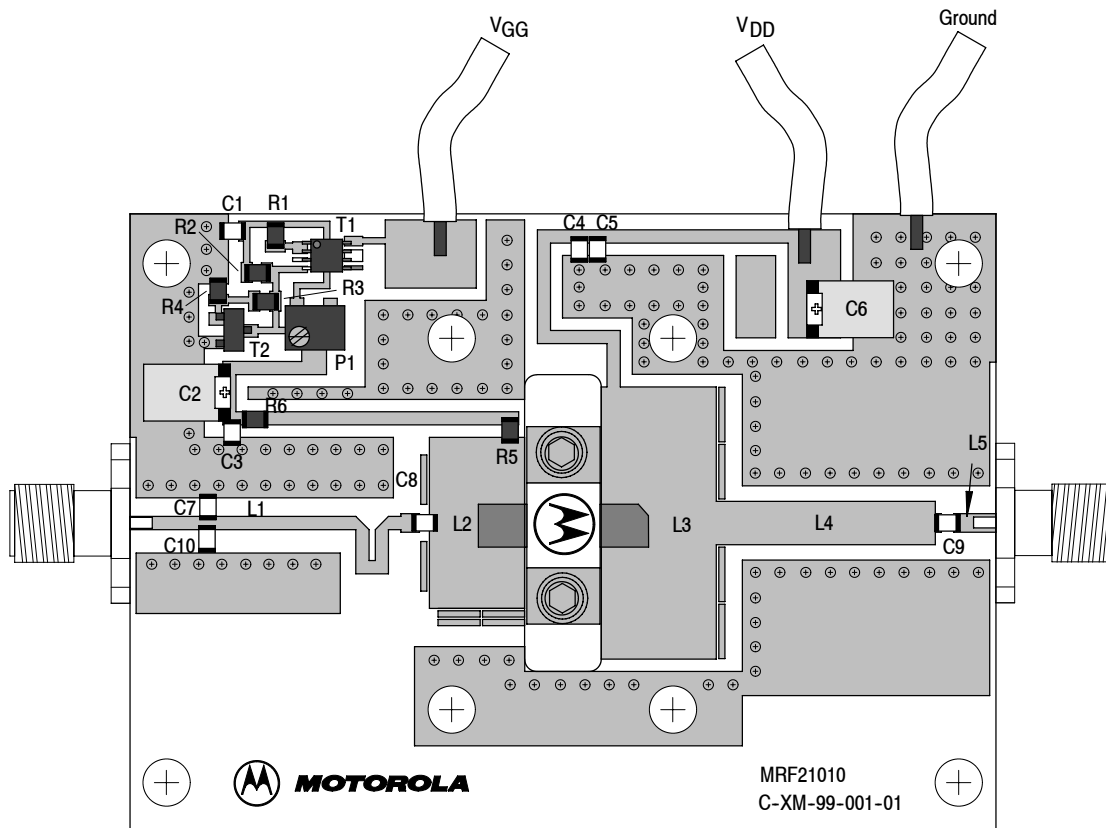

Freescale has begun the transition of marking Printed Circuit Boards (PCBs) with the Freescale Semiconductor signature/logo. PCBs may have either Motorola or Freescale markings during the transition period. These changes will have no impact on form, fit or function of the current product.

Figure 3. MRF21010L Demonstration Board Component Layout

Table 6. MRF21010L Demonstration Board Component Designations and Values

Designators	Description
C1	1 $\mu$ F Chip Capacitor (0805), Kemet C0805C105K5AC
C2, C6	10 $\mu$ F, 35 V Tantalum Capacitors, Kemet T491D106K035AT
C3, C4	6.8 pF Chip Capacitors, ACCU-P (0805), AVX #08051J6R8CBS
C5	10 nF Chip Capacitor (0805), AVX #08055C103KATS
C7	1.5 pF Chip Capacitor, ACCU-P (0805), AVX #08051J2R2BBS
C8, C10	0.5 pF Chip Capacitors, ACCU-P (0805), AVX #08051J0R5BBS
C9	10 pF Chip Capacitor, ACCU-P (0805), AVX #08055J100GBS
L1	19 mm $\times$ 1.07 mm
L2	7.7 mm $\times$ 13.8 mm
L3	9.3 mm $\times$ 22 mm
L4	17.7 mm $\times$ 3.5 mm
L5	3.4 mm $\times$ 1.5 mm
R1, R6	10 $\Omega$ , 1/8 W Chip Resistors (0805) CRCW080510R0FKEA
R2, R3	1 k $\Omega$ , 1/8 W Chip Resistors (0805) CRCW08051001FKEA
R4	2.2 k $\Omega$ , 1/8 W Chip Resistor (0805) CRCW08052201FKEA
R5	0 $\Omega$ , 1/8 W Chip Resistor (0805) CRCW08050000FKEA
P1	5 k $\Omega$ Potentiometer CMS Cermet Multi-Turn, Bourns #3224W
T1	Voltage Regulator, Micro-8, On-Semi #LP2951ACDMR2G
T2	Bipolar NPN Transistor, SOT-23, On-Semi #BC847ALT1G
PCB	Rogers RO4350, 0.5 mm, $\epsilon_r = 3.53$

## TYPICAL CHARACTERISTICS

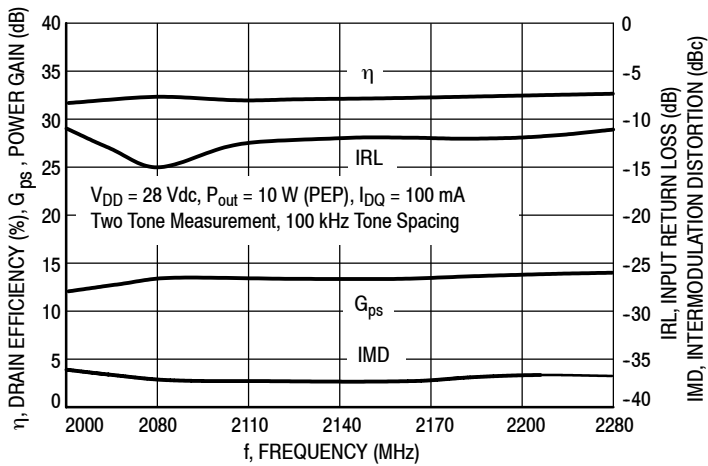

Figure 4. Class AB Broadband Circuit Performance

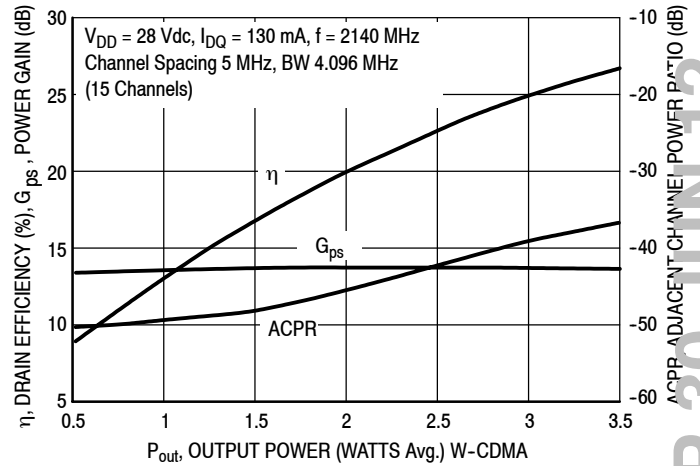

Figure 5. W-CDMA ACPR, Power Gain and Drain Efficiency versus Output Power

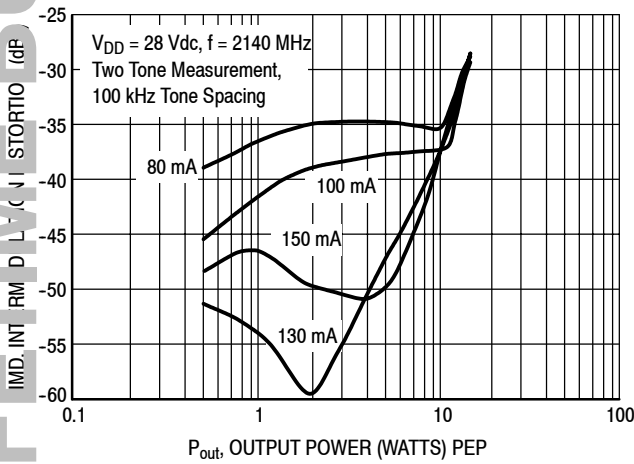

Figure 6. Intermodulation Distortion versus Output Power

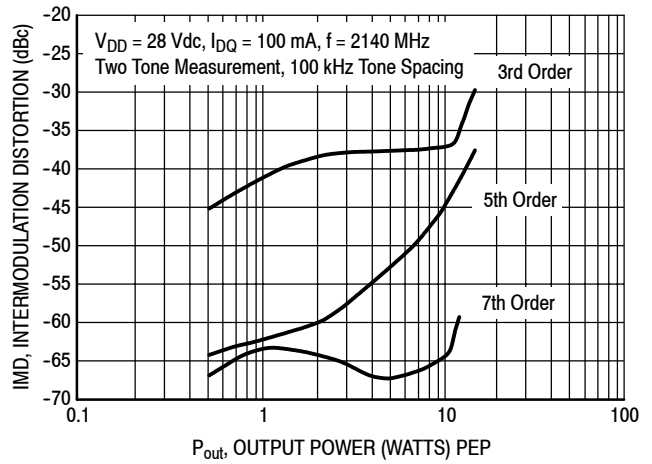

Figure 7. Intermodulation Distortion Products versus Output Power

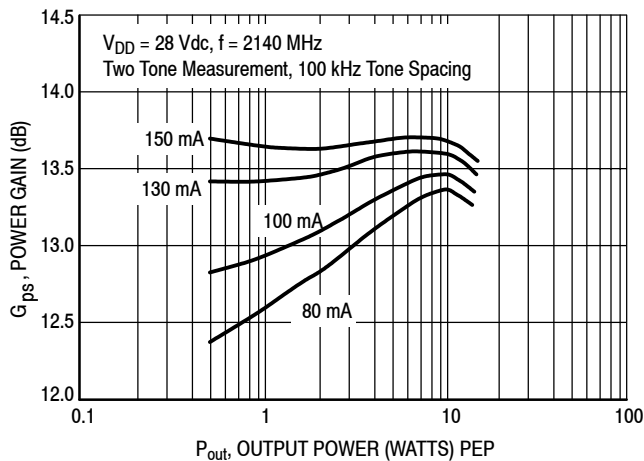

Figure 8. Power Gain versus Output Power

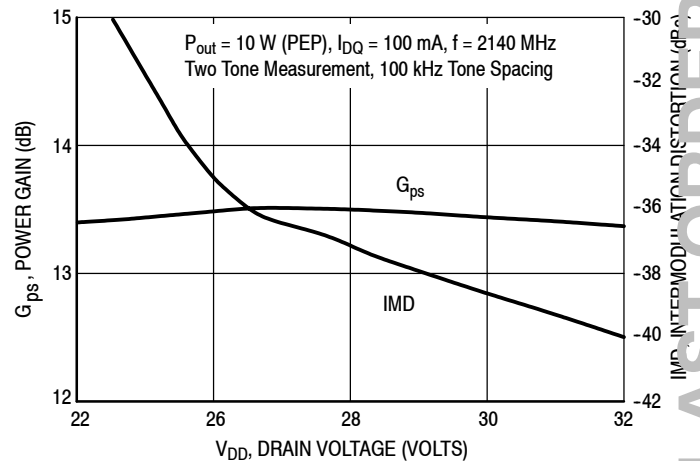
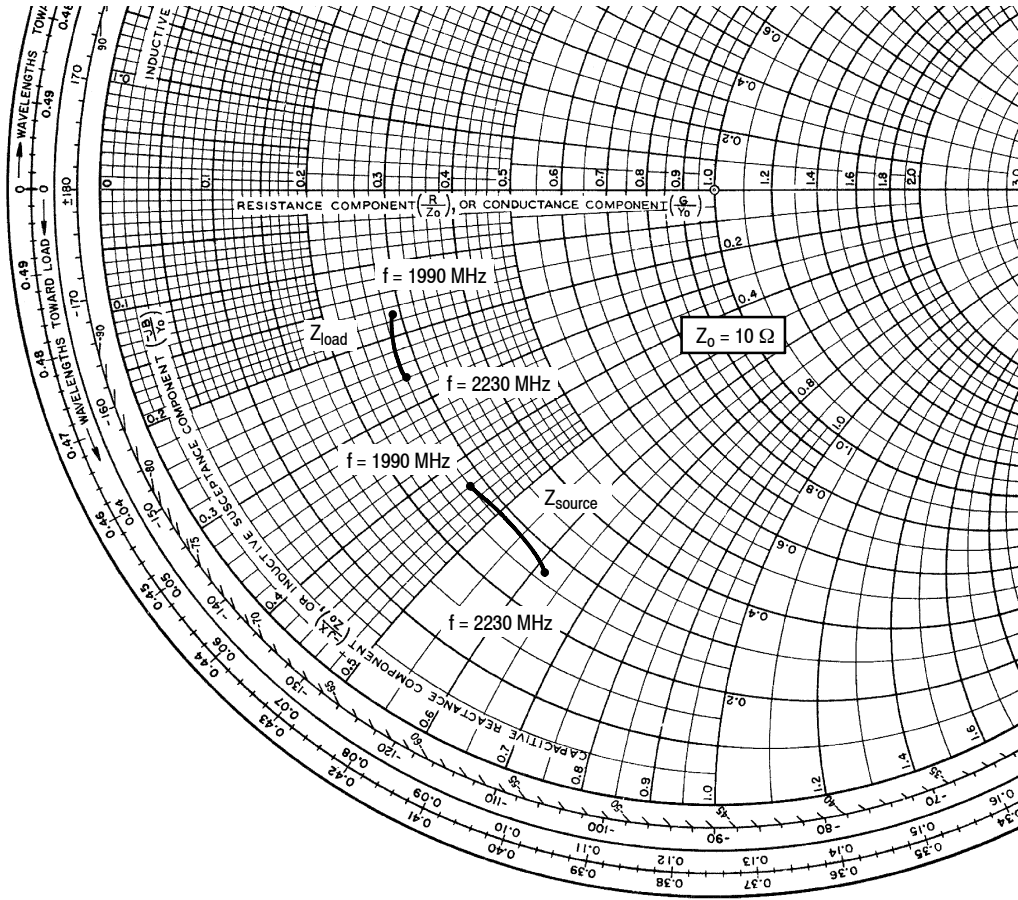

Figure 9. Intermodulation and Gain versus Supply Voltage

MRF21010LSR1



V<sub>DD</sub> = 28 V, I<sub>DQ</sub> = 100 mA, P<sub>out</sub> = 10 W PEP

f MHz	Z <sub>source</sub> Ω	Z <sub>load</sub> Ω
1990	2.85 - j4.38	2.93 - j1.71
2110	2.89 - j5.04	2.76 - j2.28
2230	2.73 - j6.19	2.83 - j2.59

Z<sub>source</sub> = Test circuit impedance as measured from gate to ground.

Z<sub>load</sub> = Test circuit impedance as measured from drain to ground.

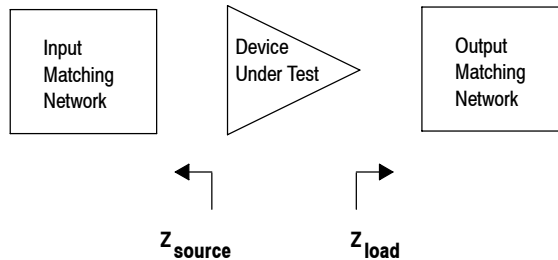
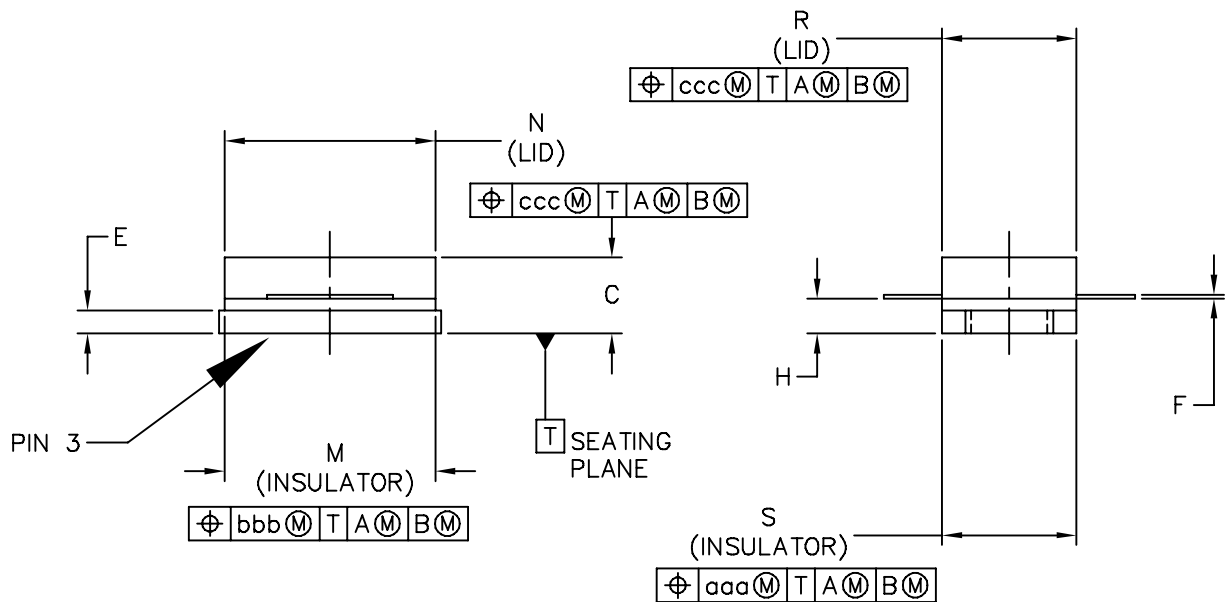
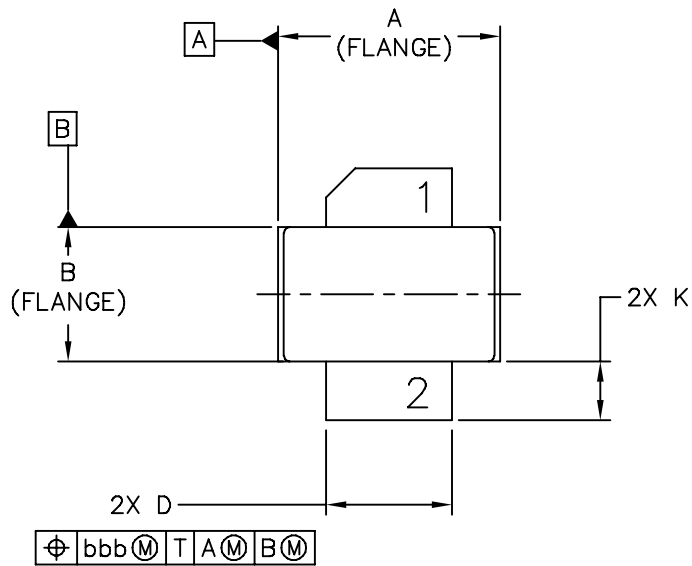

Figure 10. Series Equivalent Source and Load Impedance

## PACKAGE DIMENSIONS



© FREESCALE SEMICONDUCTOR, INC. ALL RIGHTS RESERVED.	<b>MECHANICAL OUTLINE</b>	PRINT VERSION NOT TO SCALE	
TITLE: <div style="text-align: center; padding: 5px;">                     NI-360S                      SURFACE MOUNT                 </div>	DOCUMENT NO: 98ASB14516C		REV: F
	CASE NUMBER: 360C-05		10 MAR 2006
	STANDARD: NON-JEDEC		

MRF21010LSR1

NOTES:

1. INTERPRET DIMENSIONS AND TOLERANCES PER ASME Y14.5M-1994.
2. CONTROLLING DIMENSION: INCH
3. DIMENSION H IS MEASURED .030 (0.762) AWAY FROM PACKAGE BODY

STYLE 1:  
 PIN 1 - DRAIN  
 2 - GATE  
 3 - SOURCE

DIM	INCH		MILLIMETER		DIM	INCH		MILLIMETER	
	MIN	MAX	MIN	MAX		MIN	MAX	MIN	MAX
A	.375	.385	9.53	9.78	N	.357	.363	9.07	9.22
B	.225	.235	5.72	5.97	R	.227	.233	5.77	5.92
C	.105	.155	2.67	3.94	S	.225	.235	5.72	5.97
D	.210	.220	5.33	5.59					
E	.035	.045	0.89	1.14	aaa	.005		0.13	
F	.004	.006	0.1	0.15	bbb	.010		0.25	
H	.057	.067	1.45	1.7	ccc	.015		0.38	
K	.085	.115	2.16	2.92					
M	.355	.365	9.02	9.27					
© FREESCALE SEMICONDUCTOR, INC. ALL RIGHTS RESERVED.			<b>MECHANICAL OUTLINE</b>			PRINT VERSION NOT TO SCALE			
TITLE:  NI-360S SURFACE MOUNT					DOCUMENT NO: 98ASB14516C			REV: F	
					CASE NUMBER: 360C-05			10 MAR 2006	
					STANDARD: NON-JEDEC				



## PRODUCT DOCUMENTATION

Refer to the following documents to aid your design process.

### Engineering Bulletins

- EB212: Using Data Sheet Impedances for RF LDMOS Devices

## REVISION HISTORY

The following table summarizes revisions to this document.

Revision	Date	Description
11	Oct. 2008	<ul style="list-style-type: none"><li>• Data sheet revised to reflect part status change, p. 1, including use of applicable overlay.</li><li>• Modified data sheet to reflect RF Test Reduction described in Product and Process Change Notification number, PCN12779, p. 1, 2</li><li>• Updated Part Numbers in Tables 5 and 6, Component Designations and Values, to RoHS compliant part numbers, p. 3, 4</li><li>• Replaced Case Outline 360C-05, Issue E with Issue F, p. 7, 8</li><li>• Added Product Documentation and Revision History, p. 9</li><li>• Data sheet split due to change in part life cycle. See MRF21010-1 Rev. 10 for MRF21010LR1.</li></ul>

LIFETIME BUY

LAST SHIP 30 JUN 12  
LAST ORDER 1 JUL 11

MRF21010LSR1

## **How to Reach Us:**

### **Home Page:**

[www.freescale.com](http://www.freescale.com)

### **Web Support:**

<http://www.freescale.com/support>

### **USA/Europe or Locations Not Listed:**

Freescale Semiconductor, Inc.  
Technical Information Center, EL516  
2100 East Elliot Road  
Tempe, Arizona 85284  
1-800-521-6274 or +1-480-768-2130  
[www.freescale.com/support](http://www.freescale.com/support)

### **Europe, Middle East, and Africa:**

Freescale Halbleiter Deutschland GmbH  
Technical Information Center  
Schatzbogen 7  
81829 Muenchen, Germany  
+44 1296 380 456 (English)  
+46 8 52200080 (English)  
+49 89 92103 559 (German)  
+33 1 69 35 48 48 (French)  
[www.freescale.com/support](http://www.freescale.com/support)

### **Japan:**

Freescale Semiconductor Japan Ltd.  
Headquarters  
ARCO Tower 15F  
1-8-1, Shimo-Meguro, Meguro-ku,  
Tokyo 153-0064  
Japan  
0120 191014 or +81 3 5437 9125  
[support.japan@freescale.com](mailto:support.japan@freescale.com)

### **Asia/Pacific:**

Freescale Semiconductor China Ltd.  
Exchange Building 23F  
No. 118 Jianguo Road  
Chaoyang District  
Beijing 100022  
China  
+86 10 5879 8000  
[support.asia@freescale.com](mailto:support.asia@freescale.com)

### **For Literature Requests Only:**

Freescale Semiconductor Literature Distribution Center  
P.O. Box 5405  
Denver, Colorado 80217  
1-800-441-2447 or +1-303-675-2140  
Fax: +1-303-675-2150  
[LDCForFreescaleSemiconductor@hibbertgroup.com](mailto:LDCForFreescaleSemiconductor@hibbertgroup.com)

Information in this document is provided solely to enable system and software implementers to use Freescale Semiconductor products. There are no express or implied copyright licenses granted hereunder to design or fabricate any integrated circuits or integrated circuits based on the information in this document.

Freescale Semiconductor reserves the right to make changes without further notice to any products herein. Freescale Semiconductor makes no warranty, representation or guarantee regarding the suitability of its products for any particular purpose, nor does Freescale Semiconductor assume any liability arising out of the application or use of any product or circuit, and specifically disclaims any and all liability, including without limitation consequential or incidental damages. "Typical" parameters that may be provided in Freescale Semiconductor data sheets and/or specifications can and do vary in different applications and actual performance may vary over time. All operating parameters, including "Typicals", must be validated for each customer application by customer's technical experts. Freescale Semiconductor does not convey any license under its patent rights nor the rights of others. Freescale Semiconductor products are not designed, intended, or authorized for use as components in systems intended for surgical implant into the body, or other applications intended to support or sustain life, or for any other application in which the failure of the Freescale Semiconductor product could create a situation where personal injury or death may occur. Should Buyer purchase or use Freescale Semiconductor products for any such unintended or unauthorized application, Buyer shall indemnify and hold Freescale Semiconductor and its officers, employees, subsidiaries, affiliates, and distributors harmless against all claims, costs, damages, and expenses, and reasonable attorney fees arising out of, directly or indirectly, any claim of personal injury or death associated with such unintended or unauthorized use, even if such claim alleges that Freescale Semiconductor was negligent regarding the design or manufacture of the part.

Freescale™ and the Freescale logo are trademarks of Freescale Semiconductor, Inc. All other product or service names are the property of their respective owners.  
© Freescale Semiconductor, Inc. 2008. All rights reserved.

