



RF High Power

## Freescale Broadcast Solutions

### Advanced technology to maximize broadcast transmitter performance

#### Advantages

- More than 50 years of experience delivering solid state solutions for broadcast applications
- Proven product quality, reliability and consistency
- Comprehensive portfolio, serving both driver and output stages
  - Power levels from 10W to 1250W
  - Frequency coverage from 1.8 to 860 MHz
- Broadest line of enhanced ruggedness devices
  - Field proven enhanced ruggedness process
  - Capable of handling >65:1 VSWR with 3 dB overdrive
  - Devices from 300W to 1250W
  - Frequency coverage from 1.8 to 860 MHz
- Enhanced ESD protection
- Superior thermal performance
- Cost-effective, high performance plastic package options
- RoHS compliant
- Secure, high volume manufacturing capability
- Long term commitment to all broadcast products with minimum 10 years of product availability from introduction
- Regional broadcast applications support teams

#### Overview

Freescale has been a trusted supplier of RF power semiconductors to the broadcast industry for over 50 years. Building on this history, Freescale's newest E series portfolio of 50V high-power devices enables broadcast system designers to meet increasingly demanding performance, reliability and ruggedness requirements of the HF, VHF and UHF radio and television transmitter industry.

#### Enhanced Ruggedness 50V LDMOS Technology

Freescale's latest generation of enhanced ruggedness 50V LDMOS devices brings the broadcast system designer unprecedented ruggedness combined with industry-leading performance. Freescale's enhanced ruggedness line of broadcast devices are designed to handle operating into a voltage standing wave ratio (VSWR) greater than 65:1. These attributes allow broadcast transmitter designers to meet the most challenging performance and reliability demands of today's broadcast industry.

Freescale's innovative low thermal resistance packaging technology enables higher device power densities for even the highest power designs. High device power density, combined with the high-power gain offered by Freescale's portfolio of 50V LDMOS devices simplifies designs by reducing the number of driver and output stages needed, thereby increasing reliability and reducing cost.

The broadband performance of Freescale LDMOS devices maximizes power and efficiency across complete broadcast bands by eliminating the need to tune the power amplifier for an individual channel or band segment. This simplifies production and maintenance, and reduces overhead associated with channel-specific designs.

The breadth of our high power portfolio enables broadcast transmitter designers to choose an optimal solution, capable of meeting or exceeding even the most rigorous performance requirements across any desired power level, modulation type and frequency range. The exceptional efficiency and gain cover virtually every broadcast transmitter application, including analog television, DVB-T, ISDB-T and ATSC digital television as well as AM, single sideband, FM, HD and DAB radio applications.

Freescale's RF broadcast solutions cover frequencies from 1.8 to 860 MHz with power outputs from 10 watts to an industry-leading 1250 watts.

Freescale's broadcast devices are designed to meet quality and reliability standards demanded by even the most quality-conscious transmitter manufacturers and operators.

Complementing Freescale's line of trusted LDMOS devices, the enhanced ruggedness 50V devices underscore our commitment to deliver industry-leading performance across a comprehensive broadcast system portfolio.



## Analog and Digital FM and VHF TV: 1.25 kW Output Transistor

The MRFE6VP61K25H power transistor is ideal for FM/VHF broadcast applications. The high level of output power (1.25 kW CW) and high gain (25 dB) allows for very compact lineups, providing over 70 dB gain in three stages. The exceptional efficiency, combined with low thermal resistance, considerably reduces thermal constraints.

### 1.6 kW Avg. Lineup—VHF TV

- 0.5 dB of combining loss
- >65:1 VSWR
- Compact driver design
- Compact fixture design
- DVB-T OFDM @ 10 PAR dB

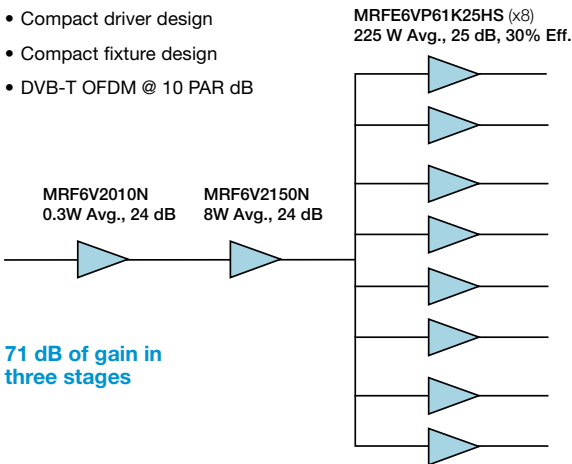

Devices	MRF6V2010N	MRF6V2150N	MRFE6VP61K25H (x8)	Totals
Typical Gain	24 dB	24 dB	25 dB	71 dB
P <sub>out</sub>	0.03W Avg.	8W Avg.	225W Avg.	1.6 kW Avg.
Drain Efficiency	5%	15%	30%	27%
IMD (Delta Marker 4.2 MHz)	-40 dBc	-40 dBc	-30 dBc	-30 dBc

### 7.8 kW Lineup—FM

- 0.5 dB of combining loss
- >65:1 VSWR
- Compact driver design
- Compact fixture design

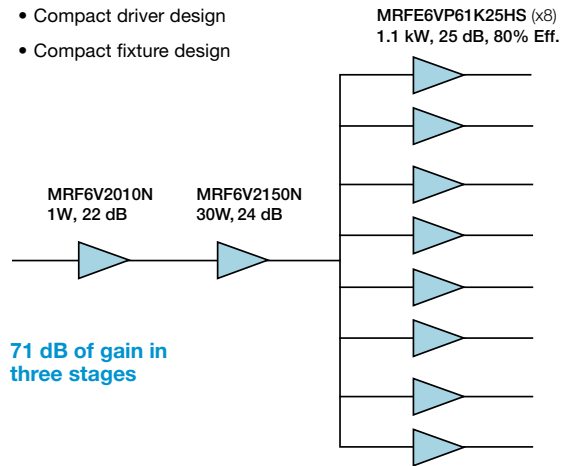

Devices	MRF6V2010N	MRF6V2150N	MRFE6VP61K25HS (x8)	Totals
Typical Gain	22 dB	24 dB	25 dB	71 dB
P <sub>out</sub>	1W	30W	1.1 kW	7.8 kW CW
Drain Efficiency	20%	33%	80%	71%

## Analog and Digital UHF TV: 450 Watt Output Transistor

The MRF6VP3091NB and MRFE6VP8600H power transistors are ideal for UHF broadcast applications. Their high output power capability and high gain enhance system-level efficiency by minimizing device count and combining losses. The exceptional efficiency of these RF power transistors can help reduce operating costs for TV broadcasters.

### MRFE6VP8600H 450W Avg. DVB-T Lineup

- Compact design
- High efficiency
- Extremely rugged
- 50V supply for both driver and output stages
- -0.5 dB splitting and combining losses

### Typical Performance—Wideband 470–860 MHz

Devices	MRF6VP3091NB	MRFE6VP8600H (x4)	Totals
Typical Gain	21 dB	19 dB	39 dB
P <sub>out</sub>	9W	125W	450W
Drain Efficiency	18%	30%	26%

5 total parts, DVB-T (8k OFDM) signal

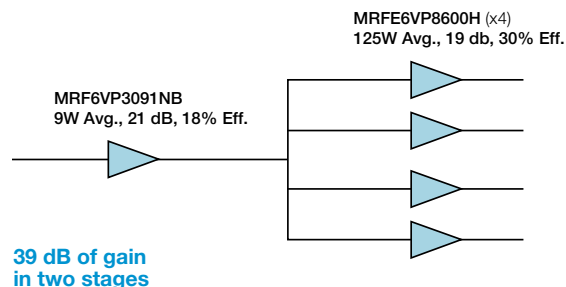

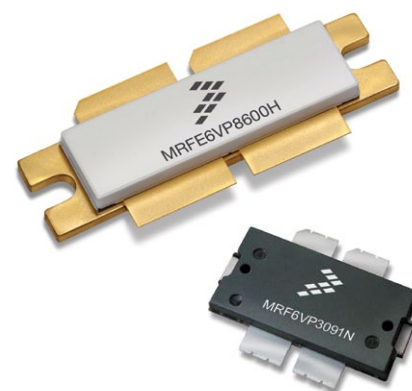

### Performance Table for Freescale 50V Broadcast Devices

Part Number	Voltage (V)	Operating Frequency (MHz)	P1dB (W)	Technology	Package	$\theta_{JC}$ °C/W <sup>(1)</sup>	Typical Gain (dB)	Typical Efficiency (%)	Reference Designs <sup>(2)</sup> and Demo Boards (MHz)
<b>HF/VHF Broadcast</b>									
MRF6V2010N/NB	50	10–450	10	VHV6	Over-Molded	3	23.9	62	CW: 27, 87.5–108 FM, 130, 220, 450
MRF6V2150N/NB	50	10–450	150	VHV6	Over-Molded	0.24	25	68.3	CW: 27, 87.5–108 FM, 220, 450 Pulsed: 130
MRFE6VP6300H/HS	50	1.8–600	300	EVHV6 Enhanced Ruggedness	Air Cavity	0.19	25	80	CW: 87.5–108 FM, 230, 500 Pulsed: 130, 450
MRF6V2300N/NB	50	10–600	300	VHV6	Over-Molded	0.24	25.5	68	CW: 27, 87.5–108 FM, 130, 425, 450 Pulsed: 170–230 Analog, 220
MRF6V4300N/NB	50	10–600	300	VHV6	Over-Molded	0.24	22	60	CW: 450
MRFE6VP5600H/HS	50	1.8–600	600	EVHV6 Enhanced Ruggedness	Air Cavity	0.12	24.6	75.2	CW: 230 Pulsed: 175–225, 230
MRF6VP2600H	50	2–500	600	VHV6	Air Cavity	0.20	25/125W (DVB-T)	28.5/125W (DVB-T)	CW: 87.5–108 FM Pulsed: 175–225 Analog, 225
MRF6VP11KH	50	10–150	1000	VHV6	Air Cavity	0.13	26	71	CW: 81, 87.5–108 FM, 100, 130 Pulsed: 15, 27
MRF6VP41KH/HS	50	10–500	1000	VHV6	Air Cavity	0.15	20	64	CW: 352, Pulsed: 450
MRFE6VP61K25H/HS	50	1.8–600	1250	EVHV6 Enhanced Ruggedness	Air Cavity	0.15	22.9	74.6	CW: 87.5–108 FM, 500 Pulsed: 170–230, 230, 352
<b>UHF Broadcast</b>									
MRF6V3090N/NB	50	470–860	90	VHV6	Over-Molded	0.79	22/18W	28.5/18W	CW: 470–860
MRF6VP3091N/NB	50	470–860	90	VHV6	Over-Molded	0.79	22/18W	28.5/18W	CW: 470–860
MRF6VP3450H/HS	50	470–860	450	VHV6	Air Cavity	0.23	22.5/90W (DVB-T)	28/90W (DVB-T)	Pulsed: 470–860
MRFE6VP8600H/HS	50	470–860	600	EVHV6 Enhanced Ruggedness	Air Cavity	0.19	19.3/125W (DVB-T) 18.8/600W (Pulsed)	30 48.9	Pulsed: 470–860, 860

(1) Refer to the respective part number data sheet for thermal measurement operating conditions.

(2) Reference designs for broadcast parts are available at: [www.freescale.com/RFbroadcast](http://www.freescale.com/RFbroadcast) > Design Support > Reference Designs.

**Note:** To order Freescale RF broadcast high power devices use Freescale's Orderable Part search feature to locate a part. Select the [Distributor](#) button under Order on the search results page to locate a listing of Distributors who can facilitate your order.

RF Power Broadcast Portfolio

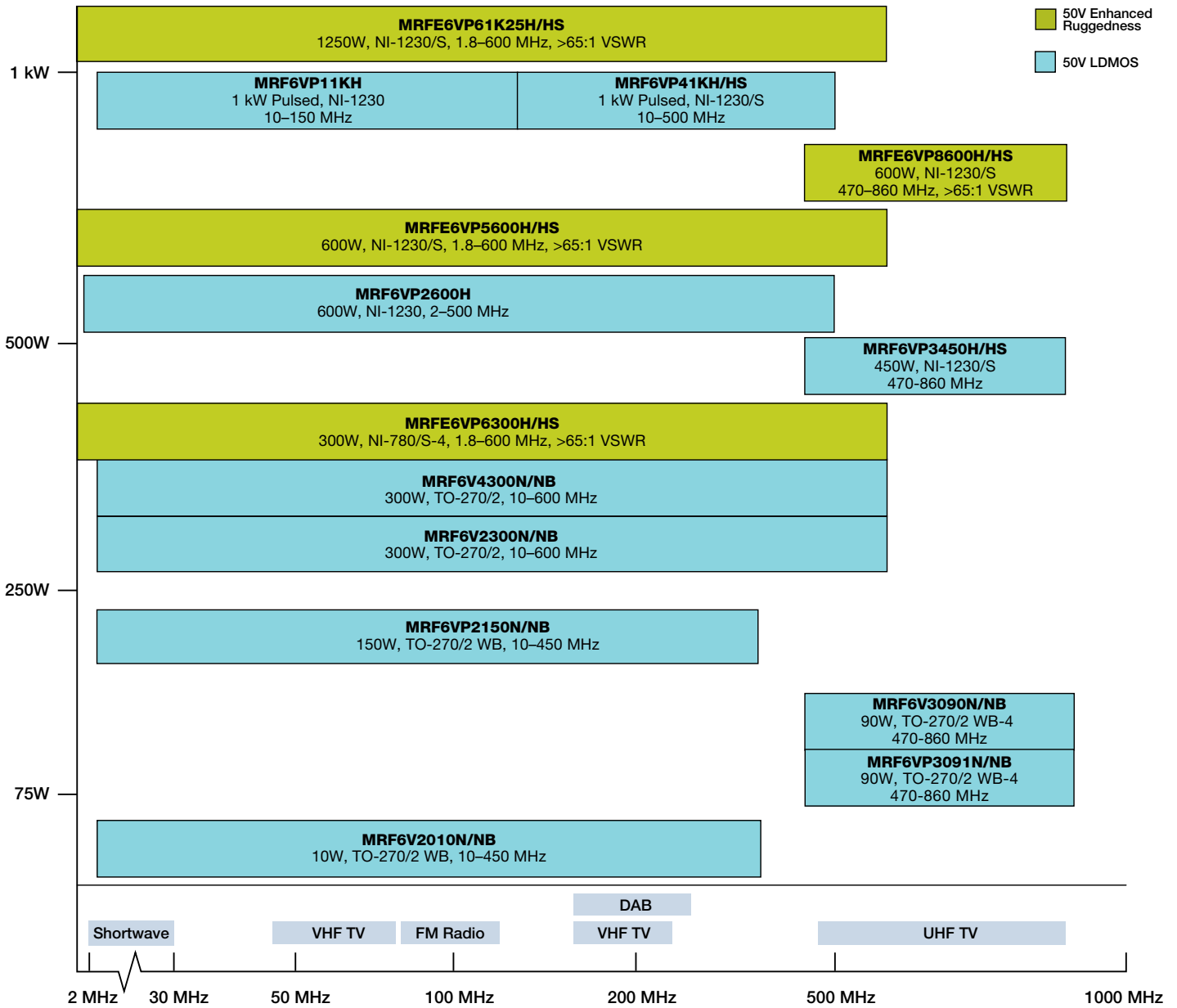

RF Power Broadcast Packages



NI-780S-4



NI-780-4

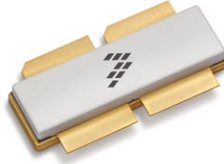

NI-1230S

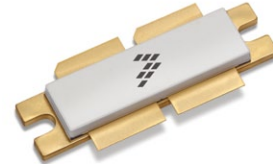

NI-1230



TO-270-2



TO-272-2



TO-270 WB-4



TO-272 WB-4

## Industry-Leading Packaging

- Thermal performance leadership
- Package design
  - Freescale's JEDEC-registered TO series is the only over-molded plastic package series specifically designed for high-power RF applications
    - Bolt down, clamp down and solder reflow mounting options
    - Low thermal resistance flange material
    - 225°C TJ maximum operating temperature
    - Power dissipation capabilities >1 kW
    - In-package impedance matching
    - Low Au solderable finish for improved reliability
    - Plastic package with a larger contact area for optimal thermal performance
- Manufacturing
  - Automated high volume assembly and test
  - Multiple manufacturing locations
- Materials
  - RoHS compliant

## Why Choose Freescale?

- Best-in-class RF performance
- Industry-leading package designs
- Consistent and repeatable RF performance
- Consistent high quality
- Proven long-term reliability
- High volume manufacturing capability
- Assured long-term supply
- Comprehensive, in-region design support

## Solder Reflow Process for RF High Power Devices

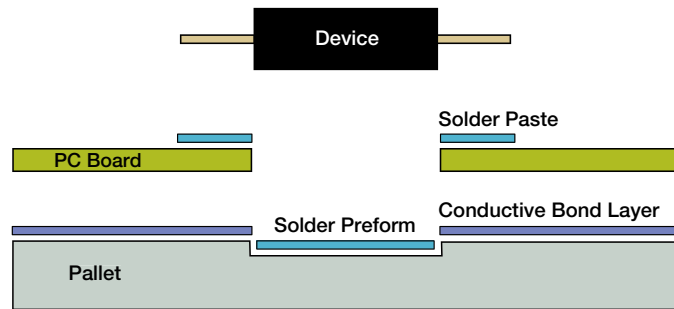

## Design Support

For information on design support for broadcast products select Design Support at [freescale.com/RFbroadcast](http://freescale.com/RFbroadcast).

- Application-specific reference designs
- Test and evaluation fixtures
- Fully validated RF high-power models for Agilent ADS and AWR Microwave Office®
- MTF calculation programs
- 50V RF LDMOS white paper
- Packaging and mounting application notes
- Thermal management application notes
- Support centers in Asia, Europe and Americas

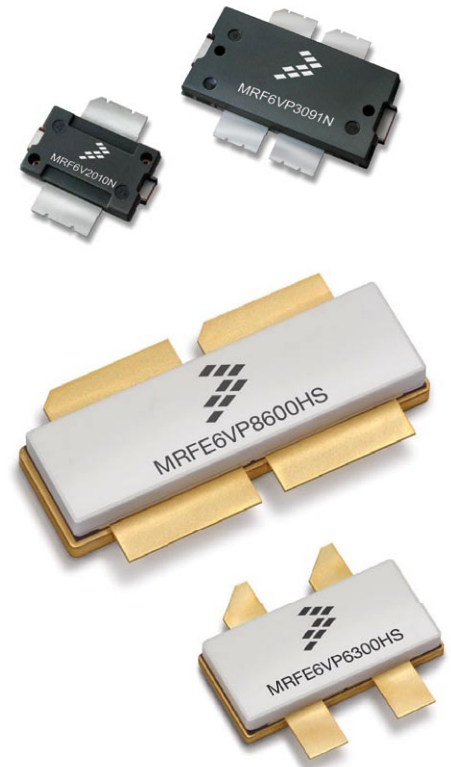

For more information, visit [freescale.com/RFpower](http://freescale.com/RFpower)

Freescale and the Freescale logo are trademarks of Freescale Semiconductor, Inc., Reg. U.S. Pat. & Tm. Off. All other product or service names are the property of their respective owners. © 2011 Freescale Semiconductor, Inc.