

# DC-DC Converter Application Manual

## MPD5D01\*S

### 1. Features

- 1.1 Miniaturized Ultra Low Profile (26.8 by 14.6 by 4.4mm Typ.) SMD.
- 1.2 Wide operating temperature range(-40 °C to +85 °C)
- 1.3 Wide input range 36V to 75V
- 1.4 Up to 10 devices in Parallel Operation.
- 1.5 Input to Output isolation: 1.5kV(DC) for one minute.
- 1.6 Built-in Over Current Protection , Over Voltage Protection & Over Heating Protection.
- 1.7 UL60950 Recognized, CE marking(LVD & EMC directive)

### 2. Product Line Up

#### 2.1 TF50A Series

Nominal Output Voltage[V]	Part No.
1.5	MPD5D013S
1.8	MPD5D014S
2.5	MPD5D016S
3.3	MPD5D017S
5.0	MPD1D018S

### 3. Ratings

- 3.1 Operating Temperature Range -40 °C to +85 °C
- 3.2 Operating Humidity Range 20% to 85%RH (No condensation )
- 3.3 Storage Temperature Range -45 °C. to +90 °C
- 3.4 Storage Humidity Range 10% to 95%RH (No condensation )

### 4. Electrical Characteristics

#### 4.1 Absolute Maximum Ratings

Items		Unit	Maximum	Remark
Minimum Input Voltage		V	0	
Maximum Input Voltage RC Pin Voltage ALM Pin Voltage	Time	Continuous	V	75
		200μs	V	90
PO Pin Voltage		V	8	
ALM Pin Maximum Sink Current		mA	10	

#### ⚠ Note:

1. This datasheet is downloaded from the website of Murata Manufacturing co., ltd. Therefore, it's specifications are subject to change or our products in it may be discontinued without advance notice. Please check with our sales representatives or product engineers before ordering.
2. This datasheet has only typical specifications because there is no space for detailed specifications. Therefore, please approve our product specifications or transact the approval sheet for product specifications before ordering.

## 4.2 General Characteristics(Statics , Ambient temperature : Ta=-40 to +85 °C)

Item	Unit	Value	Remark
Rated Input Voltage	V	48	
Input Voltage Range	V	36 to 60	With natural air convection 40LFM(0.2m/s)
		36 to 75	With forced air convection 100LFM(0.5m/s)
Turn-on Input Voltage	V	32.0 to 36.0	
Hysterisis Voltage	V	Minimum 2	Input voltage difference between turn-on and turn-off
Galvanic Isolation Voltage	Vdc	Minimum 1500	For one minute between input and output
EMC (Radiated EMI / Conduction)		In accordance with CISPR Publication22,Class A (VCCI Class A)	Refer to section 10. Measurement Setup
Safty Standards		UL60950(UL / C-UL)	Recognized
CE Marking		Attached	Self-declaration

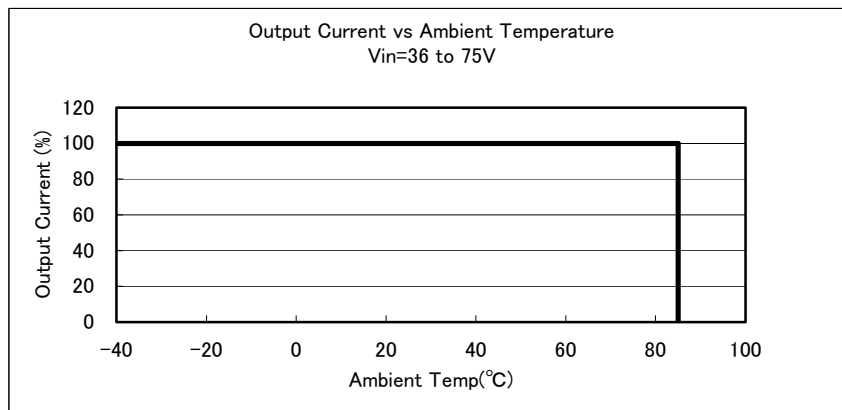
⚠ **Note:**

1. This datasheet is downloaded from the website of Murata Manufacturing co., ltd. Therefore, it's specifications are subject to change or our products in it may be discontinued without advance notice. Please check with our sales representatives or product engineers before ordering.
2. This datasheet has only typical specifications because there is no space for detailed specifications. Therefore, please approve our product specifications or transact the approval sheet for product specifications before ordering.

## 4.3 Output Characteristics Ta = -40 to 85 °C

Model		MPD5D***S					
		013	014	016	017	018	Unit
Items							
Nominal Output Voltage		1.5	1.8	2.5	3.3	5.0	V
Output Voltage Regulation Vin =36 to 75V Output current range = 0 to 100%		+5%,-3%					%
Nominal Output Current Vin=36 to 60V with 40LFM Vin=36 to 75V with 100LFM Note 1		0.8	1.0	1.2	1.5	1.0	A
Output Current- limit Inception	0.82	1.03	1.23	1.54	1.03	10.3	A
Over Voltage Protection : Note 2	1.80	2.16	3.00	3.96	6.00	6.00	V
Low Voltage Protection :Note 3	1.35	1.62	2.25	2.97	4.50	4.50	V
Efficiency(typ.) Ta=25 °C, Vin = 48V, Nominal output current		70	75	80	84	85	%
Output Ripple and Noise	Max	50 Note 4					mVp-p

Note 1: This series has NO temperature de-rating so that the nominal output current is available up to the maximum operating temperature.



Note 2: Output halted in latch-up mode after mask time 0.5ms(typ.), preventing DC-DC Converter from malfunction by external noise and/or transient output voltage change.

Note 3: Output halted in latch-up mode after mask time 500ms(typ.), preventing DC-DC Converter from malfunction by external noise and/or transient output current change.

Note 4: Refer to section 10. Measurement Setup.

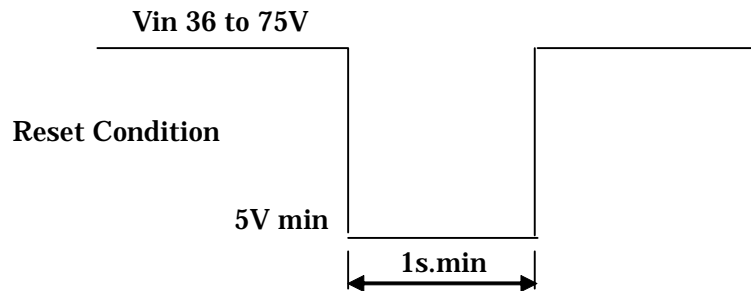
⚠ **Note:**

1. This datasheet is downloaded from the website of Murata Manufacturing co., ltd. Therefore, it's specifications are subject to change or our products in it may be discontinued without advance notice. Please check with our sales representatives or product engineers before ordering.
2. This datasheet has only typical specifications because there is no space for detailed specifications. Therefore, please approve our product specifications or transact the approval sheet for product specifications before ordering.

## 5 Operation Information

### 5.1 Reset Condition

In order to reset all functions, the input voltage ( $V_{in}$ ) must be set under 5V for 1s. min.



### 5.2 Over Voltage Protection (OVP)

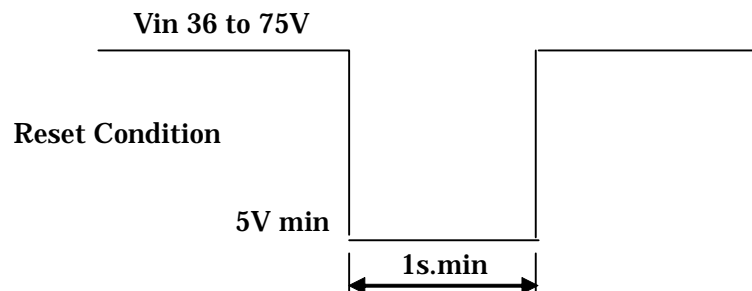
The Isolated DC-DC Converter enters latch-up mode after typical 0.5ms. mask time, when the output voltage is over the value specified in Over Voltage Protection (section 8.1.2) by failure of internal control circuit.

In order to reset, the input voltage must be set under 5V for 1s. min.

Output voltage might exceed the point at which OVP starts to function under conditions of transient input voltage or output current changes.

Therefore, OVP is set to wait for the mask time 0.5ms.

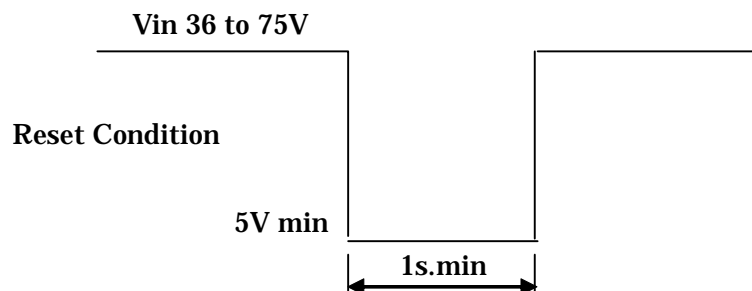
It is recommended to evaluate your appliances installed with the DC-DC Converter.



### 5.3 Low Voltage Protection (LVP)

The Isolated DC-DC Converter enters latch-up mode after typical 500ms. mask time, when the output voltage is under the value specified in Low Voltage Protection (section 8.1.2) by operating Over Current-limit Inception due to failure of internal control or over load.

In order to reset, the input voltage must be set under 5V for 1s. min.



#### ⚠ Note:

1. This datasheet is downloaded from the website of Murata Manufacturing co., ltd. Therefore, it's specifications are subject to change or our products in it may be discontinued without advance notice. Please check with our sales representatives or product engineers before ordering.
2. This datasheet has only typical specifications because there is no space for detailed specifications. Therefore, please approve our product specifications or transact the approval sheet for product specifications before ordering.

#### 5.4 Remote On/Off Control

The connection to a RC pin controls an Isolated DC-DC Converter to turn on/off.

While the Isolated DC-DC Converter is halted via the remote control feature, the alarm function will not operate; refer to Alarm Output (section 5-5).

Start : RC open or connected to -Vin  
Halt : RC connected to +Vin

#### 5.5 Alarm Output (ALM)

The Alarm Output can be down to the level of -Vin (Open Drain Output), when Over Voltage Protection or Low Voltage Protection features are activated. The sink current in ALM pin is 10mA max. Multiple Isolated DC-DC Converters running independently and / or in parallel operation can be simultaneously halted by connecting all ALM pins, when the Over Voltage Protection or Low Voltage Protection functions are activated by any single DC-DC Converter. The maximum number connected running DC-DC Converters is 10pcs. To connect more than 10, please consult Murata.

#### 5.6 Synchronous Turn-on/off

Multiple Isolated DC-DC Converters running independently and / or in parallel operation can be synchronously toggled on & off timing among the running converters, of which the input voltage detection circuits are tied to the detection voltage of a single reference Isolated DC-DC Converter. Every PO pin must be connected for multiple and/or parallel operation.

The Maximum number connected running DC-DC Converters is 10pcs.

It is possible in using other DC-DC Converters with other MPD6D\*\*\*S or MPD7 D\*\*\*S series for multiple and/or parallel operation.

For more detailed information, please consult Murata.

### 6 Parallel Operation

#### 6.1 Parallel Operation Description (Current sharing)

When the output current required is more than that available from one DC-DC Converter an alternative rather than choosing a higher power rated DC-DC Converter is to operate multiple DC-DC Converters in parallel.

It is possible to run up to 10pcs in parallel operation.

This series are applicable for parallel operation with other MPD6D\*\*\*S or MPD7 D\*\*\*S series.

PO pins should be connected so that the turn-on / off of all connected DC-DC Converters are synchronized. Additionally connecting the ALM pins of the devices in parallel operation enables simultaneous shut down of all DC-DC Converters when one is halted and generates an ALM signal due to an OVP or LVP condition.

#### 6.2 Load Balance in Parallel Operation

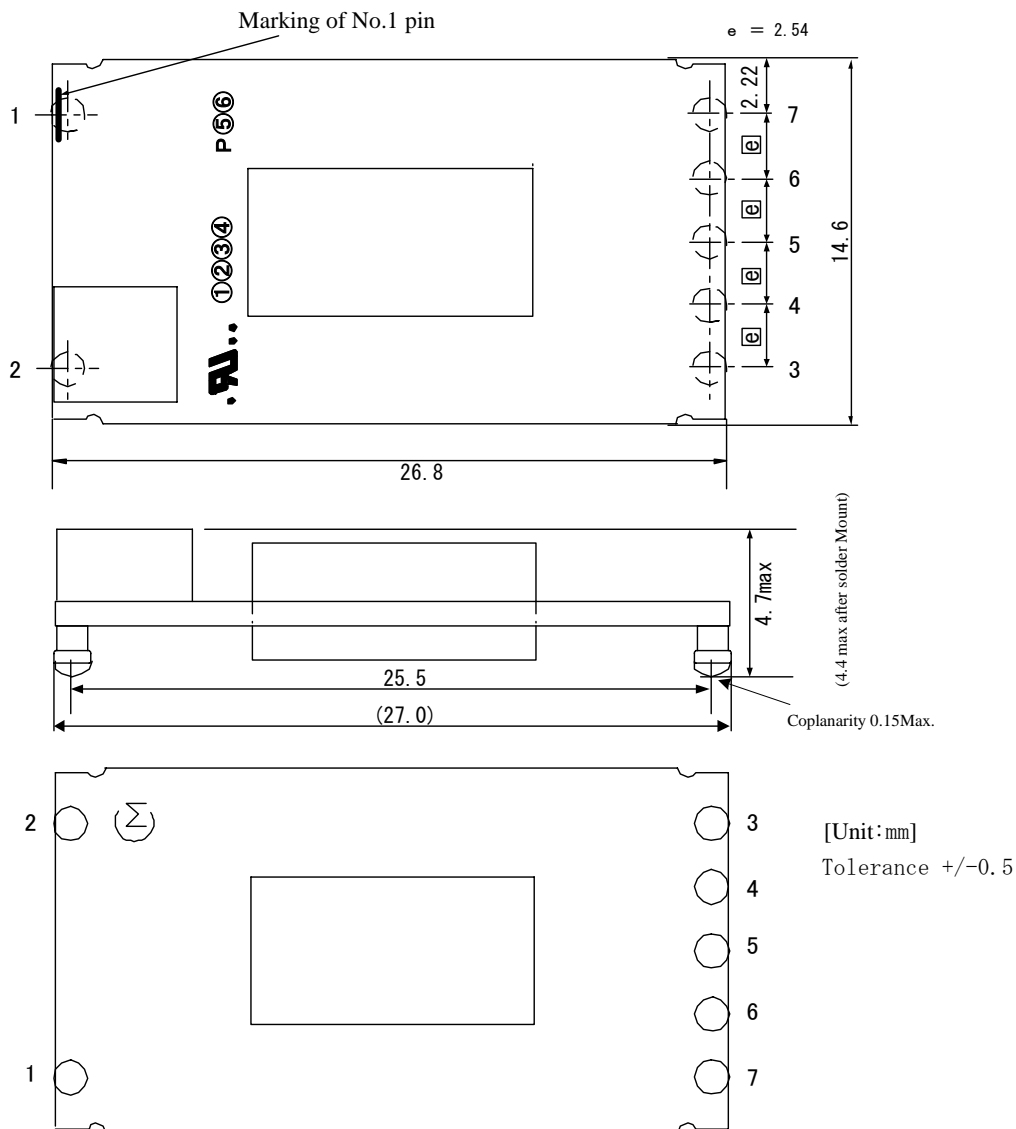
Neither external load balancing circuit nor reverse-current prevention circuit is necessary for Murata's DC-DC Converters operating in parallel. Murata's DC-DC Converters are designed to regulate load balancing and prevent reverse-current.

The combined devices operated in parallel provide an output voltage within the tolerance specified for either device (e.g. +5% / -3%). This tolerance is maintained throughout the output current variance from zero to the rated current value. This feature automatically balances the output currents from all of the parallel DC-DC Converters

#### ⚠ Note:

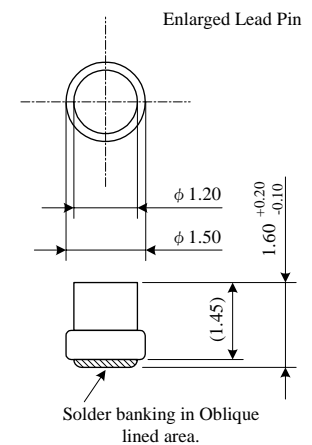
1. This datasheet is downloaded from the website of Murata Manufacturing co., ltd. Therefore, it's specifications are subject to change or our products in it may be discontinued without advance notice. Please check with our sales representatives or product engineers before ordering.
2. This datasheet has only typical specifications because there is no space for detailed specifications. Therefore, please approve our product specifications or transact the approval sheet for product specifications before ordering.

## 7. Appearance, Dimensions



## Marking

- (1) Product Number Code P\*\* Refer to table 1  
 (2) MFG ID M  
 (3) Lot No. ①②③④⑤⑥  
 ① Production factory Mark  
 ② Production Year  
 ③ Production Month (1,2,3,...9,O,N,D)  
 ④ Product Modification Number (No Marking Now)  
 ⑤⑥ Last two letters of Product Number Code P\*\*



## ⚠ Note:

- This datasheet is downloaded from the website of Murata Manufacturing co., ltd. Therefore, it's specifications are subject to change or our products in it may be discontinued without advance notice. Please check with our sales representatives or product engineers before ordering.
- This datasheet has only typical specifications because there is no space for detailed specifications. Therefore, please approve our product specifications or transact the approval sheet for product specifications before ordering.

Table 1 Product Number Code

Code	Product Number
P L P	MPD5D018S
P L O	MPD5D017S
P M U	MPD5D016S
P M S	MPD5D014S
P M R	MPD5D013S

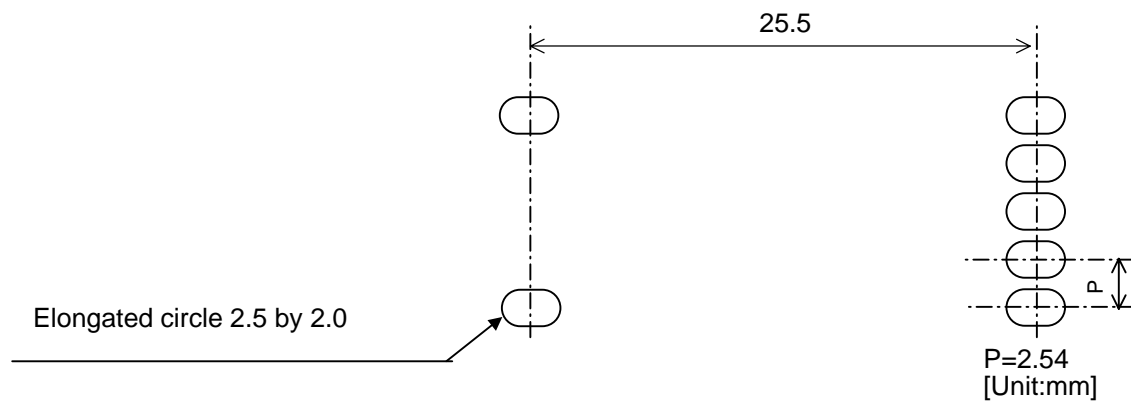
Pin Number, Function

Pin No.	Designation	Function
1	+Vout	+Output
2	-Vout	-Output
3	ALM	Alarm Note1
4	RC	Remote On/Off Control
5	PO	Parallel Operation Note2
6	+ Vin	+ Input
7	- Vin	- Input

Note 1: Any DC-DC Converter halted by abnormal operation forces all DC-DC converters, connected via ALM pins for parallel and/or multiple operation, to discontinue operation.

Note 2: DC-DC Converters connected via PO pins can start via synchronized timing for parallel and/or multiple operation.

## 8. Recommendable Foot Print Pattern



Note 1: Solder paste should be printed at the center of the elongated circle. Aperture in a solder stencil is 1.5mm in diameter and thickness of the solder stencil is 0.15mm.

Note 2: It is recommended that the measurement be taken with dipping thermal setting resin at adequate points of bottom of DC-DC Converter, when the devices are mounted on the motherboard underside. The dipping points are the surface of a metal core cover. Otherwise the devices may fall from the motherboard during the secondary reflow process.

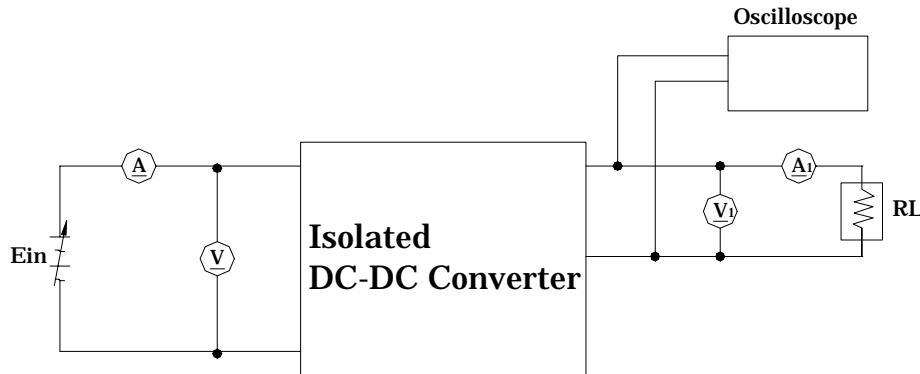
### ⚠ Note:

1. This datasheet is downloaded from the website of Murata Manufacturing co., ltd. Therefore, it's specifications are subject to change or our products in it may be discontinued without advance notice. Please check with our sales representatives or product engineers before ordering.
2. This datasheet has only typical specifications because there is no space for detailed specifications. Therefore, please approve our product specifications or transact the approval sheet for product specifications before ordering.

9. Measurement Setup

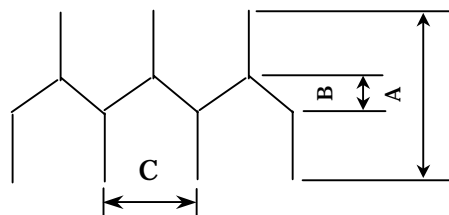
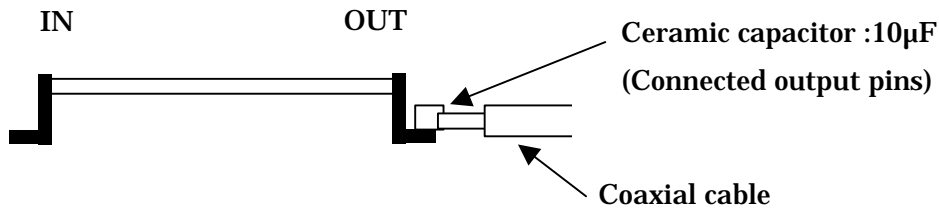
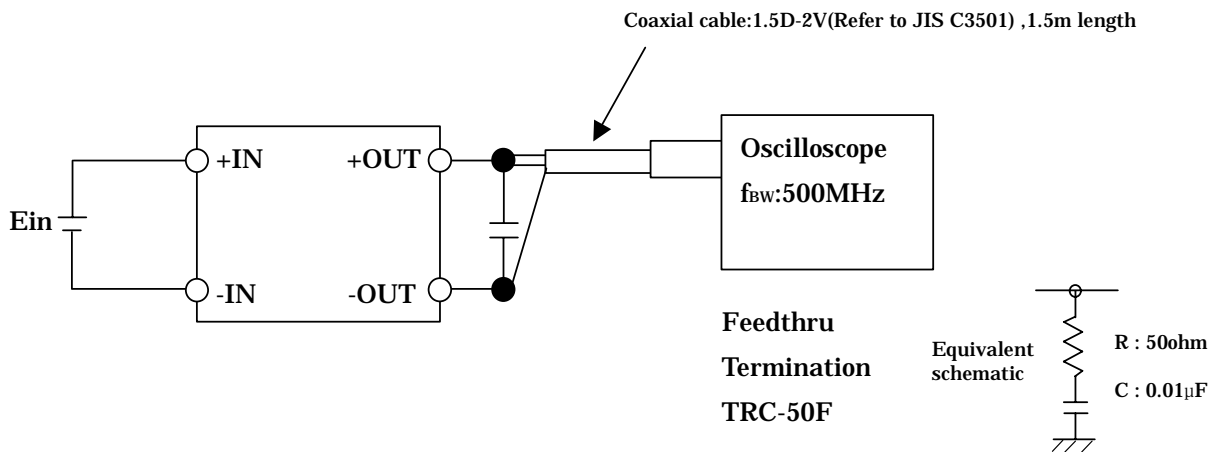
Please follow the below indicated connections when measurements are conducted. Otherwise measured values may deviate from the specifications.

9.1 General Measurement Circuit



**Ein** : Stabilized DC Power Supply  
**(A) (V)** : Multimeter  
**RL** : Electronic or Resistive Load

9.2 Output Ripple & Noise



**A**: Output Ripple & Noise  
**B**: Output Ripple  
**C**: Switching Period

⚠ **Note:**

1. This datasheet is downloaded from the website of Murata Manufacturing co., ltd. Therefore, it's specifications are subject to change or our products in it may be discontinued without advance notice. Please check with our sales representatives or product engineers before ordering.
2. This datasheet has only typical specifications because there is no space for detailed specifications. Therefore, please approve our product specifications or transact the approval sheet for product specifications before ordering.



## 10. Characteristics Data

Fig.10.1~Fig.10.5 expresses the standard characteristic of MPD5D01\*S series( $T_a=25^\circ\text{C}$ )

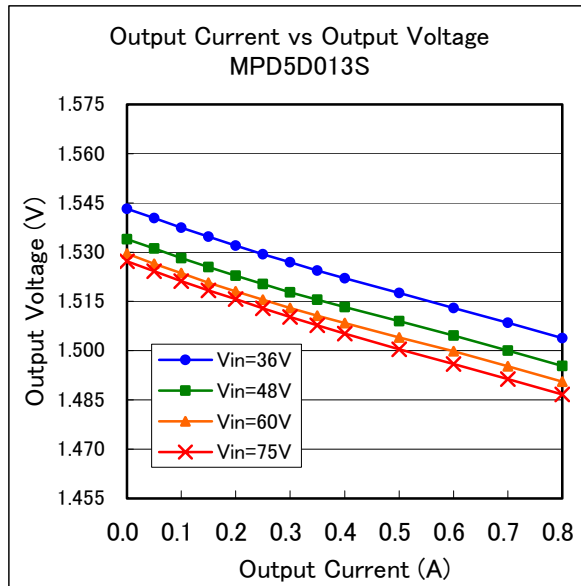
10. 1 MPD5D013 (1.5Vout) Characteristics Data ( $T_a = 25^\circ\text{C}$ , Cout:None)

Fig.10.1.1 Output Voltage vs Output Current

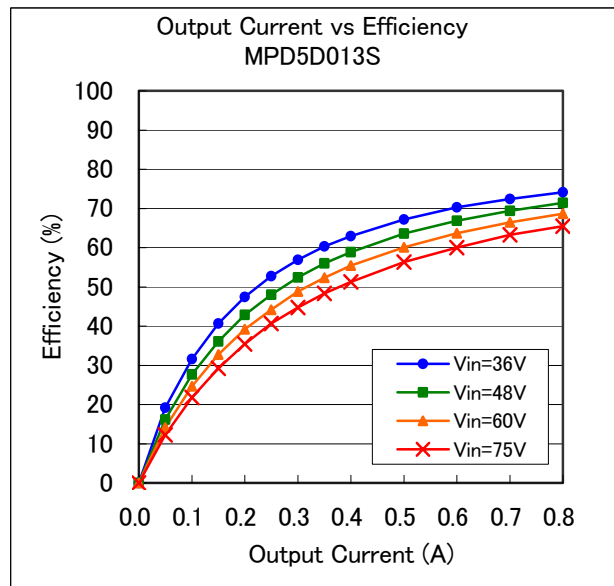


Fig.10.1.2 Efficiency vs Output Current

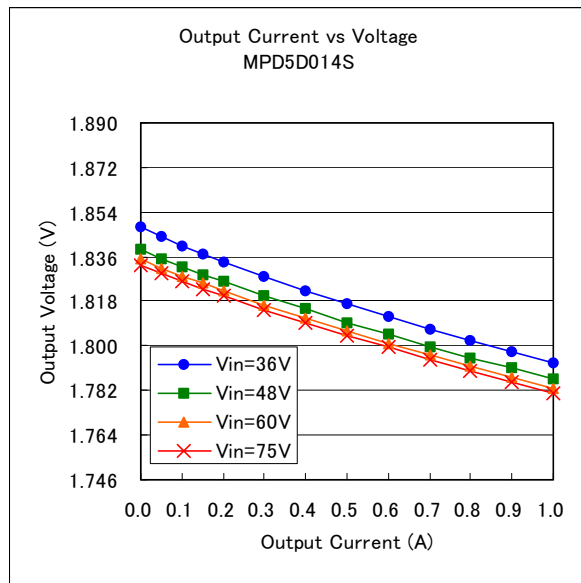
10. 2 MPD5D014S (1.8Vout) Characteristics Data ( $T_a = 25^\circ\text{C}$ , Cout:None)

Fig.10.2.1 Output Voltage vs Output Current

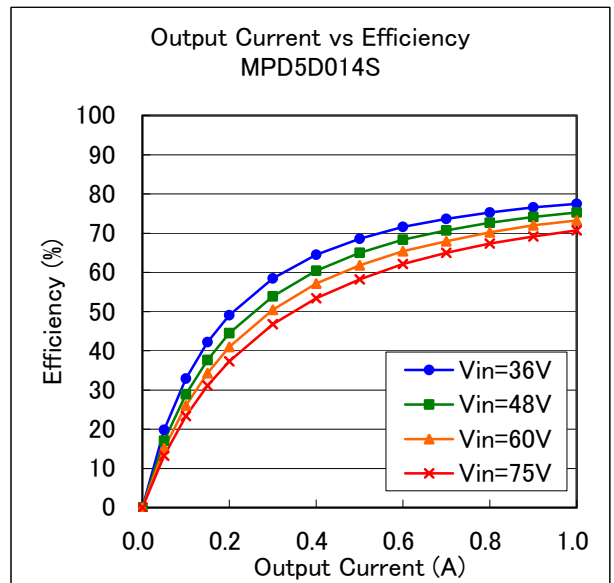


Fig.10.2.2 Efficiency vs Output Current

## ⚠ Note:

1. This datasheet is downloaded from the website of Murata Manufacturing co., ltd. Therefore, it's specifications are subject to change or our products in it may be discontinued without advance notice. Please check with our sales representatives or product engineers before ordering.
2. This datasheet has only typical specifications because there is no space for detailed specifications. Therefore, please approve our product specifications or transact the approval sheet for product specifications before ordering.

## 10.3 MPD5D016S (2.5Vout) Characteristics Data (Ta = 25 °C, Cout:None)

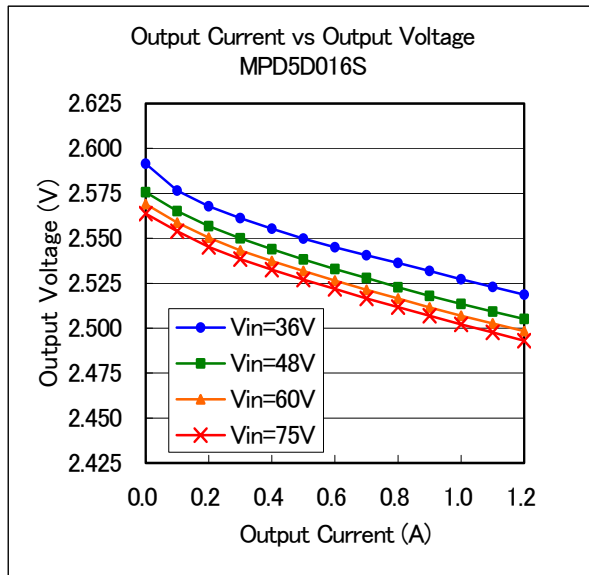


Fig.10.3.1 Output Voltage vs Output Current

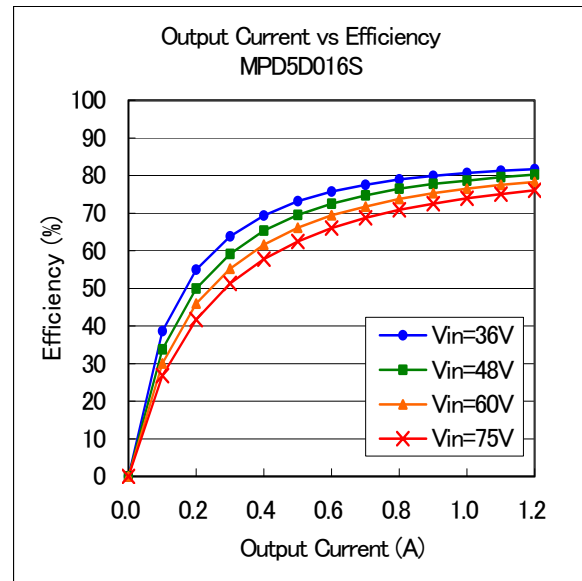


Fig.10.3.2 Efficiency vs Output Current

## 10.4 MPD5D017S (3.3Vout) Characteristics Data (Ta = 25 °C, Cout:None)

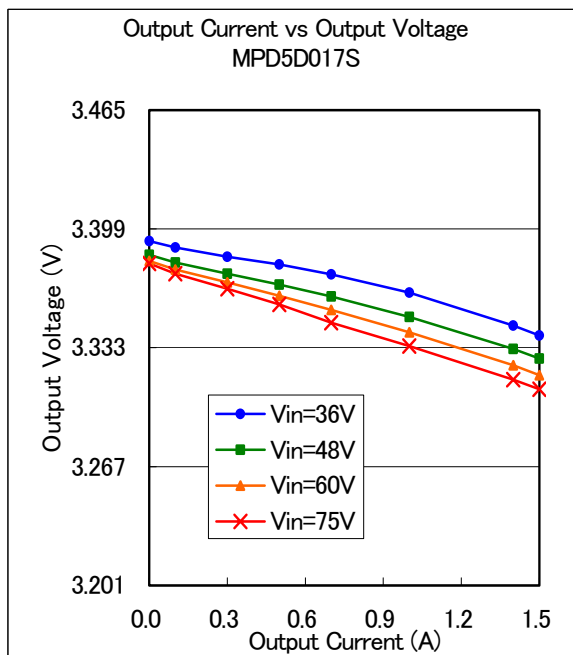


Fig.10.4.1 Output Voltage vs Output Current

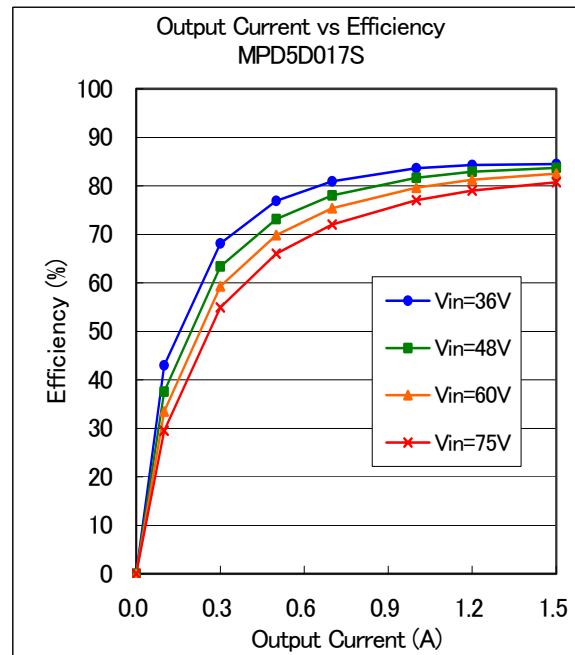


Fig.10.4.2 Efficiency vs Output Current

## ⚠ Note:

1. This datasheet is downloaded from the website of Murata Manufacturing co., ltd. Therefore, it's specifications are subject to change or our products in it may be discontinued without advance notice. Please check with our sales representatives or product engineers before ordering.
2. This datasheet has only typical specifications because there is no space for detailed specifications. Therefore, please approve our product specifications or transact the approval sheet for product specifications before ordering.

## 10. 5 MPD5D018S (5Vout) Characteristics Data (Ta = 25 °C, Cout:None)

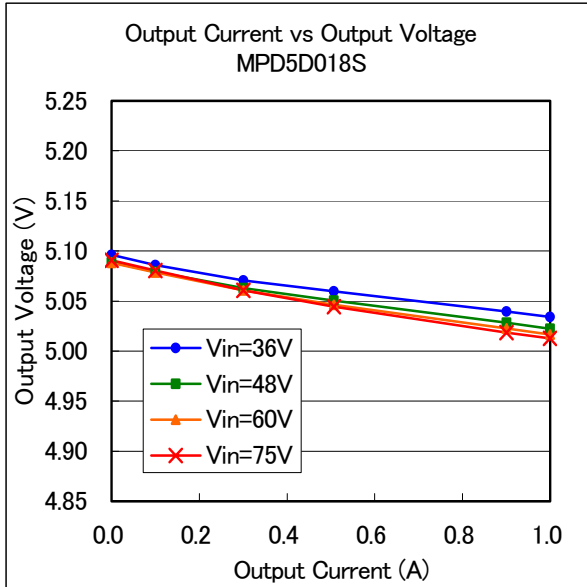


Fig.10.5.1 Output Voltage vs Output Current

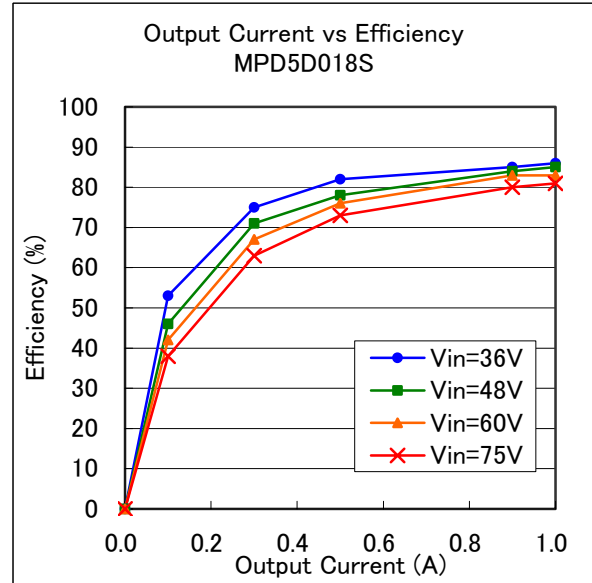


Fig.10.5.2 Efficiency vs Output Current

## ⚠ Note:

1. This datasheet is downloaded from the website of Murata Manufacturing co., ltd. Therefore, it's specifications are subject to change or our products in it may be discontinued without advance notice. Please check with our sales representatives or product engineers before ordering.
2. This datasheet has only typical specifications because there is no space for detailed specifications. Therefore, please approve our product specifications or transact the approval sheet for product specifications before ordering.

## 11. External Input-Output capacitor

### <External Input capacitor>

When an inductance or a switch device are connected to the input line, the DC-DC converter is influenced in the load response and may cause unusual oscillations, please connect an external input capacitors in such a case.

### <External output capacitor>

When applying an external output capacitor, the total output capacitance should be the following maximum value or less.

Maximum Total External Output Capacitance Value: 400 micro F.

If you use output capacitor of exceed 400 micro F, please contact us.

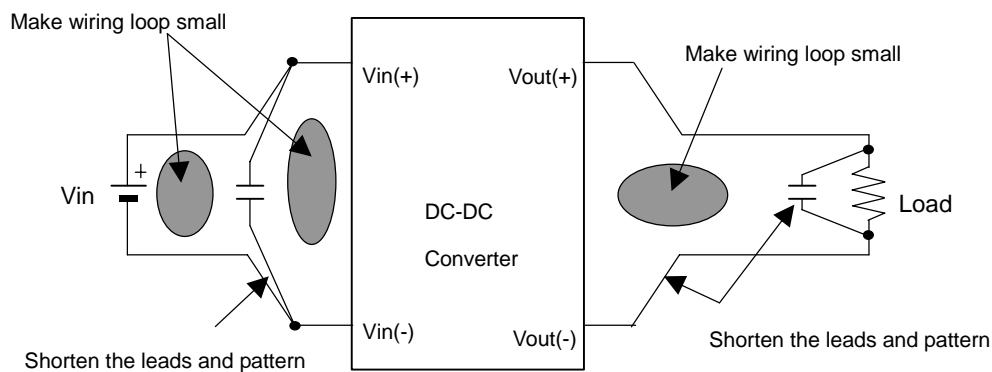


The above capacitance value is specified under the measurement via a sufficient DC power supply. When connecting an input inductance or an input power supply that has a large output inductance, please confirm the operation including nearby circuitry. The input inductance may cause unusual oscillation of DC-DC Converter.

### Input / Output capacitor

Input / output capacitor connections; in order to minimize noise, please consider the following items.

- ① Be sure to carry out a system characteristic check.
- ② Use a low impedance capacitor with good high frequency characteristics.
- ③ Shorten the leads of each capacitor as much as possible to minimize lead inductance.
- ④ Make the area of wiring loop small in the input and output line to minimize leakage inductance.
- ⑤ Shorten the length of PCB pattern and widen patterns for main circuit.

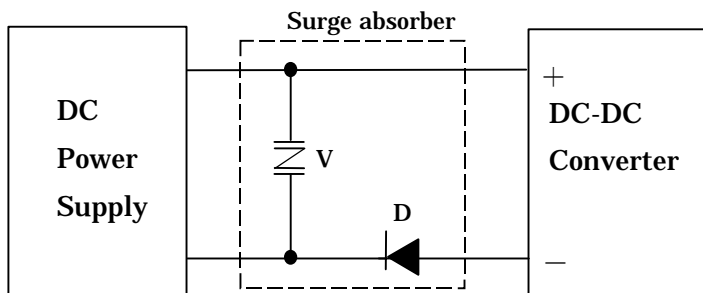


### ⚠ Note:

1. This datasheet is downloaded from the website of Murata Manufacturing co., ltd. Therefore, it's specifications are subject to change or our products in it may be discontinued without advance notice. Please check with our sales representatives or product engineers before ordering.
2. This datasheet has only typical specifications because there is no space for detailed specifications. Therefore, please approve our product specifications or transact the approval sheet for product specifications before ordering.

## 12. Caution

- 12.1 This product should not be operated in parallel or series with other DC-DC Converters.
- 12.2 Please do not use a connector or a socket for connection to your board of this product. Contact resistance may influence the performance of DC-DC Converters.
- 12.3 Be sure to provide an appropriate fail-safe function on your product to prevent secondary damage that may be caused by abnormal function or failure of the DC-DC converter.
- 12.4 Please connect the input terminals with the correct polarity. If an error in polarity connection is made the DC-DC converter may be damaged. If the DC-DC Converter is damaged internally, elevated input current may flow, and so the DC-DC converter may exhibit an abnormal temperature rise, or your product may be damaged. Please add a Diode and Varistor per the following diagram to protect them.



Diode : FCF0A40  
(Nihon Inter Corporation)

Varistor : NVD14SC082

Please select Diode and Varistor after confirming the operation.

### ⚠ Note

1. Please contact our main sales office or nearby sales office before using our products for the applications listed below which require especially high reliability for the prevention of defects which might directly cause damage to the third party's life, body or property or this products for any other applications that described in the above.

Aircraft equipment  
Aerospace equipment  
Undersea equipment  
Power plant control equipment  
Medical equipment  
Transportation equipment (vehicles, trains, ships, etc.)  
Traffic signal equipment  
Disaster prevention /crime prevention equipment  
Data-processing equipment

Application of similar complexity and/or reliability requirements to the applications listed in the above.

2. This document was released in April 2006. The contents are subject to change without notice. Please confirm specifications when ordering. If there are questions regarding the contents, please ask to our main sales office or nearby sales office.
3. Types and specification in this document are referenced for your information only. Please confirm detailed specifications by approving our individual drawing and specification sheet.

### ⚠ Note:

1. This datasheet is downloaded from the website of Murata Manufacturing co., ltd. Therefore, it's specifications are subject to change or our products in it may be discontinued without advance notice. Please check with our sales representatives or product engineers before ordering.
2. This datasheet has only typical specifications because there is no space for detailed specifications. Therefore, please approve our product specifications or transact the approval sheet for product specifications before ordering.