

DC-DC Converter DATA Sheet

MYSSM01202BENL

1. Features

- Wide input voltage range. (17V~40V)
- Single Output Voltage/High Current and Surface Mount Type Non-insulated Type DC-DC Converter.
- Ultra small size and low profile.
- High Efficiency product.
- Wide adjustable output voltage by connecting external resistors. (5.0 to 12.0V)
- On/Off function and short circuit protection is built in.



2. Appearance, Dimensions

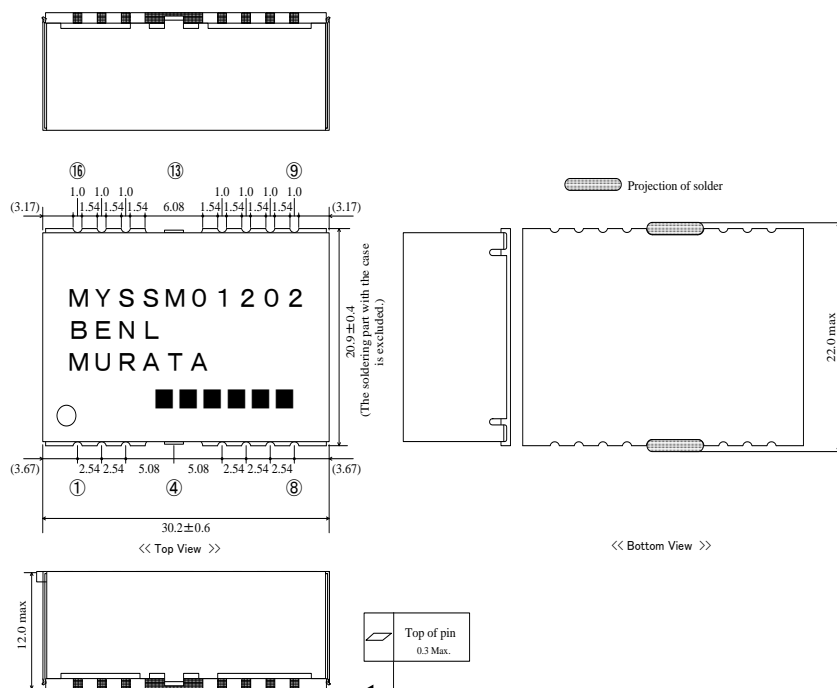

【Unit: mm】

Tolerance ± 0.3 mm
Toleranc is not accumulated.

Note:

1. This datasheet is downloaded from the website of Murata Manufacturing co., ltd. Therefore, it' s specifications are subject to change or our products in it may be discontinued without advance notice. Please check with our sales representatives or product engineers before ordering.

Marking

(1) Manufacturer Parts No. MYSSM01202BENL
 (2) Manufacturer ID MURATA
 (3) Lot No. ■■■■■■

①②③④④④

- ① Production factory Mark
- ② Production Year
- ③ Production Month(1,2,3,.....,9,O,N,D)
- ④ Production Lot No.

(4) Pin No.1 Side Marking ○

Pin Number and Function

| Pin No. | Symbol | Function |
|---------------------|--------|---------------------------|
| 1,2,3 | Vin | Input |
| 4,5,6,7,13,14,15,16 | GND | GND |
| 8 | VAR | Output voltage adjustment |
| 9 | ON/OFF | Remote ON/OFF |
| 10,11,12 | Vout | Output |

3. Block Diagram

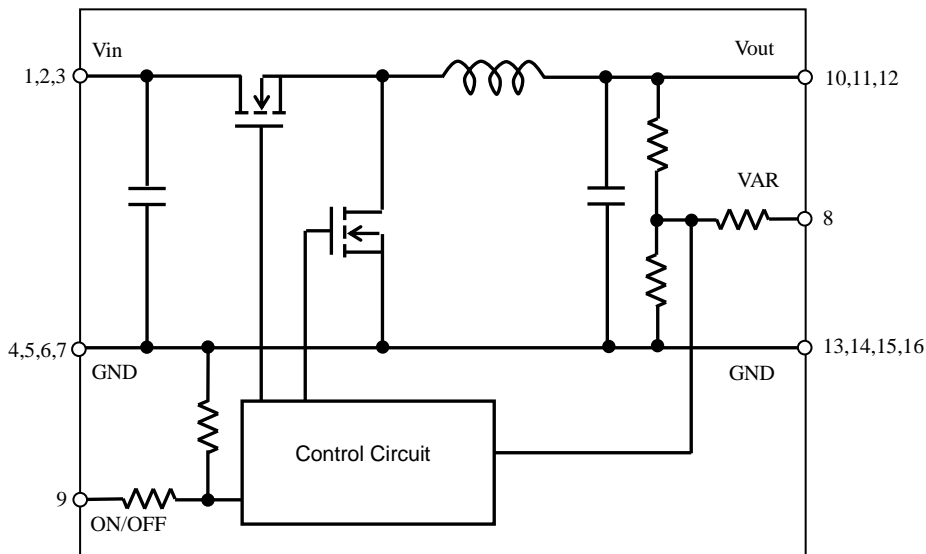

Note:

1. This datasheet is downloaded from the website of Murata Manufacturing co., Ltd. Therefore, it's specifications are subject to change or our products in it may be discontinued without advance notice. Please check with our sales representatives or product engineers before ordering.
2. This datasheet has only typical specifications because there is no space for detailed specifications. Therefore, please approve our product specifications or transact the approval sheet for product specifications before ordering.

4. Environmental Conditions

- 4.1 Operating Temperature Range -10 °C ~ +80 °C
- 4.2 Storage Temperature Range -20 °C ~ +85 °C
- 4.3 Operating Humidity Range 10% ~ 85%(No water condenses in any cases.)
- 4.4 Storage Humidity Range 5% ~ 90%(No water condenses in any cases.)

5. Absolute Maximum Rating

| Item | Unit | Absolute Rating | Remarks |
|-----------------------|------|-----------------|---------|
| Maximum Input Voltage | V | 45 | |
| ON/OFF | V | Vin | |

※No voltage, no matter how instantaneous, shall be applied beyond the absolute maximum voltage rating to this product. If you apply any voltage over this limit the product characteristics will deteriorate or the product itself will be destroyed. Even though it may continue operating for a while after the over-voltage event, its life will likely be shortened significantly. Reliability and life of the module may degrade similarly if the maximum operating voltage rating is continuously exceeded. This product is designed to operate within the maximum operating voltage rating specification.

6. Characteristics

6.1 Electrical Characteristics (Ta=25 °C)

| Item | Symbol | Condition | Value | | | Unit | |
|--------------------|---------|--|-----------|--------|--------|---------|---|
| | | | Min. | Typ. | Max. | | |
| Input Voltage | Vin | | +17.0 | +34.0 | +40.0 | V | |
| Output Voltage | Vout | Vin=17.0~40.0V Iout=0~2.0A | Rvar=0Ω | +11.64 | +12.00 | +12.36 | V |
| | | | Rvar=Open | +4.85 | +5.00 | +5.15 | |
| Output Current | Iout | Vin=17.0~40.0V | 0 | - | 2.0 | A | |
| Ripple Voltage | Vrip | Vin =34.0V, Vout=12.0V,Iout=2A BW=20MHz | - | 100 | - | mV(p-p) | |
| Efficiency | EFF | Vin =34.0V, Vout=12.0V,Iout=2A | - | 94 | - | % | |
| ON/OFF Voltage | VON/OFF | Vin=17.0~40.0V | OFF | 2.5 | - | Vin | V |
| | | | ON | - | - | 0.5 | |
| | | | OPen | | | | |
| Protection Circuit | SCP | If output is shorted to GND , DC-DC Converter shall be operated in a hiccup mode. After the short circuit event has cleared, the output is automatically brought back into regulation. | | | | | |

 **Note:**

1. This datasheet is downloaded from the website of Murata Manufacturing co., Ltd. Therefore, it's specifications are subject to change or our products in it may be discontinued without advance notice. Please check with our sales representatives or product engineers before ordering.
2. This datasheet has only typical specifications because there is no space for detailed specifications. Therefore, please approve our product specifications or transact the approval sheet for product specifications before ordering.

6.2 Output Current Derating

When using this product at $T_a \geq 50^\circ\text{C}$, it is used by the following output current de-rating.

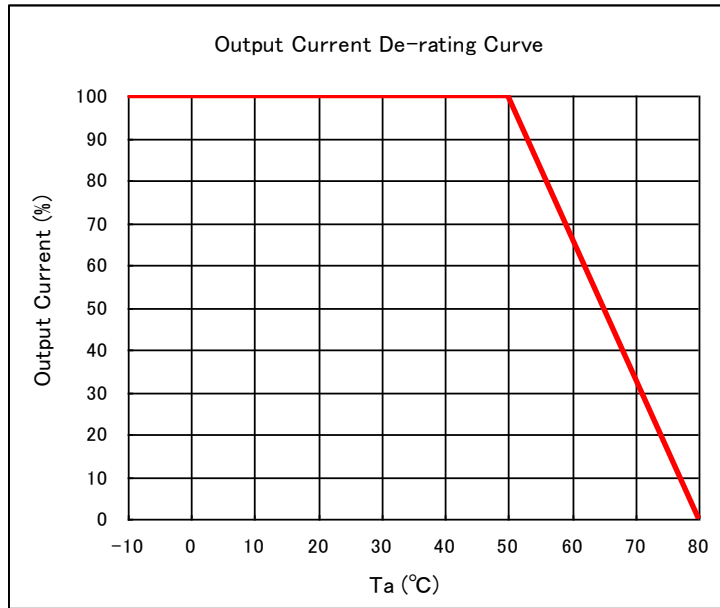

7. Operation in information

7.1 Output Voltage Adjustment

The output voltage can be adjusted ranging by connecting resistors between VAR-pin(8pin) to GND-pin. The following equation gives the required external-resistor value to adjust the output voltage to V_{oadj} . It is strictly recommended to evaluate the characteristics of DC-DC Converter at your board conditions.

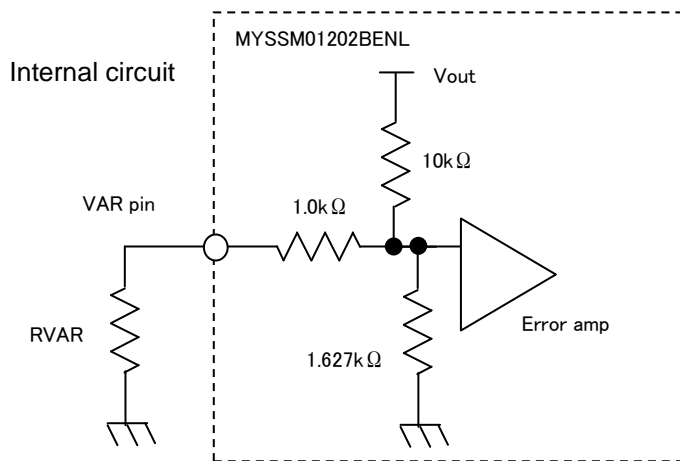

$$RVAR = \frac{10 \times 0.7}{V_{o-adj} - \left(\frac{10}{1.627} + 1\right) \times 0.7} - 1.0 \text{ [k}\Omega\text{]}$$

< RVAR calculation example >

| Voadj [V] | Calculated RVAR[Ω] | RVAR example |
|-----------|--------------------|--------------|
| 12.0 | 0 | 0Ω |
| 5.0 | -2921 | Open |

Note:

1. This datasheet is downloaded from the website of Murata Manufacturing co., ltd. Therefore, it's specifications are subject to change or our products in it may be discontinued without advance notice. Please check with our sales representatives or product engineers before ordering.
2. This datasheet has only typical specifications because there is no space for detailed specifications. Therefore, please approve our product specifications or transact the approval sheet for product specifications before ordering.

7.2 ON/OFF control

ON/OFF function

The DC-DC Converter can be inactive by using ON/OFF function.

ON/OFF control method

When ON/OFF-pin(9pin) is connected to Vin

• • • Output Voltage=OFF

When ON/OFF-pin(9pin) is connected to GND or Open

• • • Output Voltage=ON

Usage example

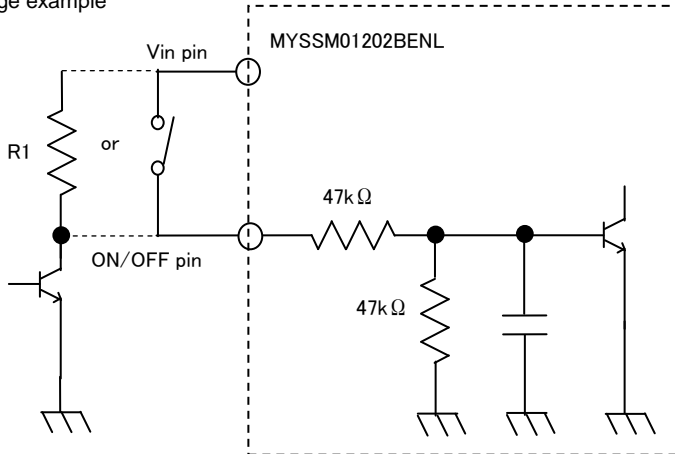

※ R1=10kΩ ~ 100kΩ

8. Reliability

8.1 Humidity

According to JIS-C-0022.

40 ±2°C, 90 to 95%RH, 100 hours. Leave for 4 hours at room temperature.

No damage in appearance and no deviation from electrical characteristics (section 6.1.).

8.2 Temperature Cycles

Repeat cycle 5 times. Leave 2 hours at room temp.

No damage in appearance and no deviation from electrical characteristics (section 6.1.).

| Step | Condition | Time |
|------|------------|--------------|
| 1 | -40°C±3°C | 30 minutes |
| 2 | Room Temp. | 5-10 minutes |
| 3 | +85°C±2°C | 30 minutes |
| 4 | Room Temp. | 5-10 minutes |

8.3 Vibration

10 to 55Hz, 1.5mm amplitude (1minute cycle), 1 hour for each of X, Y, Z directions.

No damage in appearance and no deviation from electrical characteristics (section 6.1.).

8.4 Mechanical Shock

20G, 1 time for each X, Y, Z directions.

No damage in appearance and no deviation from electrical characteristics (section 6.1.).

Note:

1. This datasheet is downloaded from the website of Murata Manufacturing co., ltd. Therefore, it's specifications are subject to change or our products in it may be discontinued without advance notice. Please check with our sales representatives or product engineers before ordering.
2. This datasheet has only typical specifications because there is no space for detailed specifications. Therefore, please approve our product specifications or transact the approval sheet for product specifications before ordering.

9. Test Circuit

In the following test circuit, the initial values under item 6.1. should be met.

9.1. General Measure Circuit

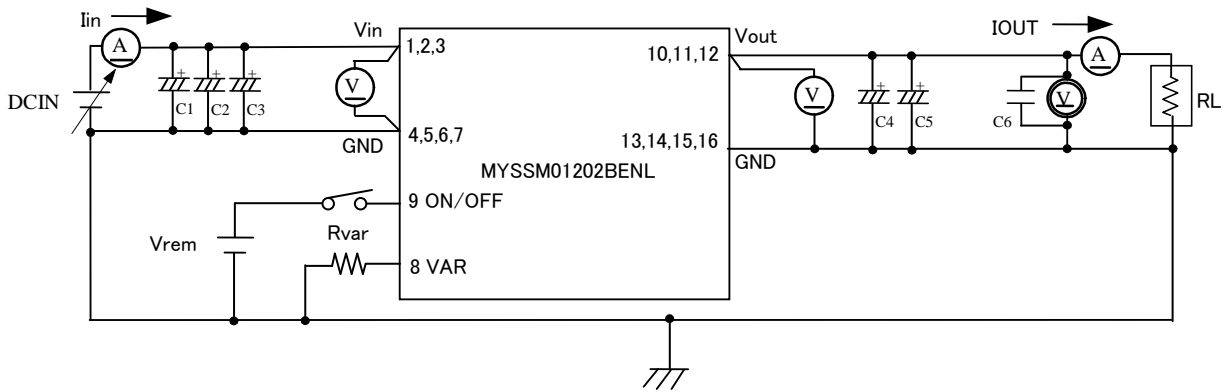

C1,C2,C3 : Low ESR Electrolytic Capacitor 220 μ F/50V (50CE220KX ϕ 10 \times L10.2 : SUNCON)
 C4,C5 : Low ESR Electrolytic Capacitor 330 μ F/16V (16CE330KX ϕ 8 \times L10.2 : SUNCON)

9.2. Ripple Voltage Measurement Circuit

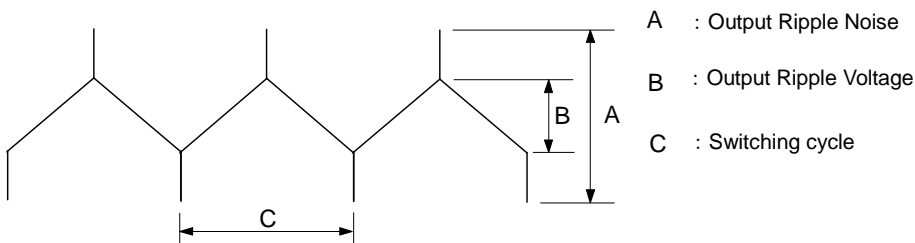
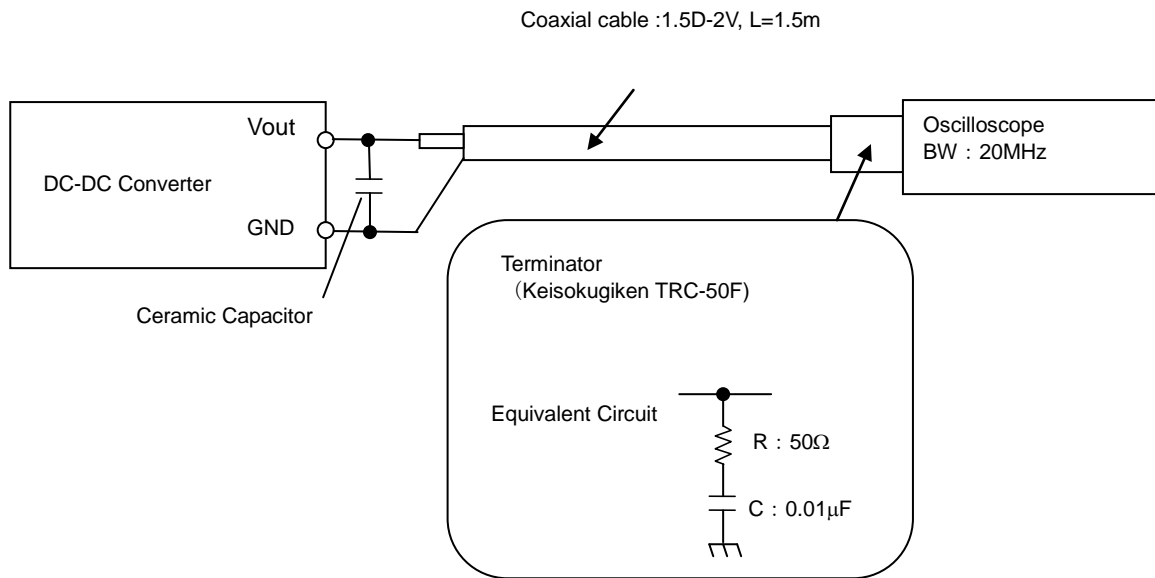

Note:

1. This datasheet is downloaded from the website of Murata Manufacturing co., Ltd. Therefore, it's specifications are subject to change or our products in it may be discontinued without advance notice. Please check with our sales representatives or product engineers before ordering.
2. This datasheet has only typical specifications because there is no space for detailed specifications. Therefore, please approve our product specifications or transact the approval sheet for product specifications before ordering.

10. Packaging Specification

10.1. Packing Form

These are packed in a tray(See Fig.10-1)

10.2. The number of products in pack specification form

32pcs./tray

If the products have fraction,may not follow this specification.

10.3. Packaging Form

These trays packed products are packaging in a corrugated box alternately.

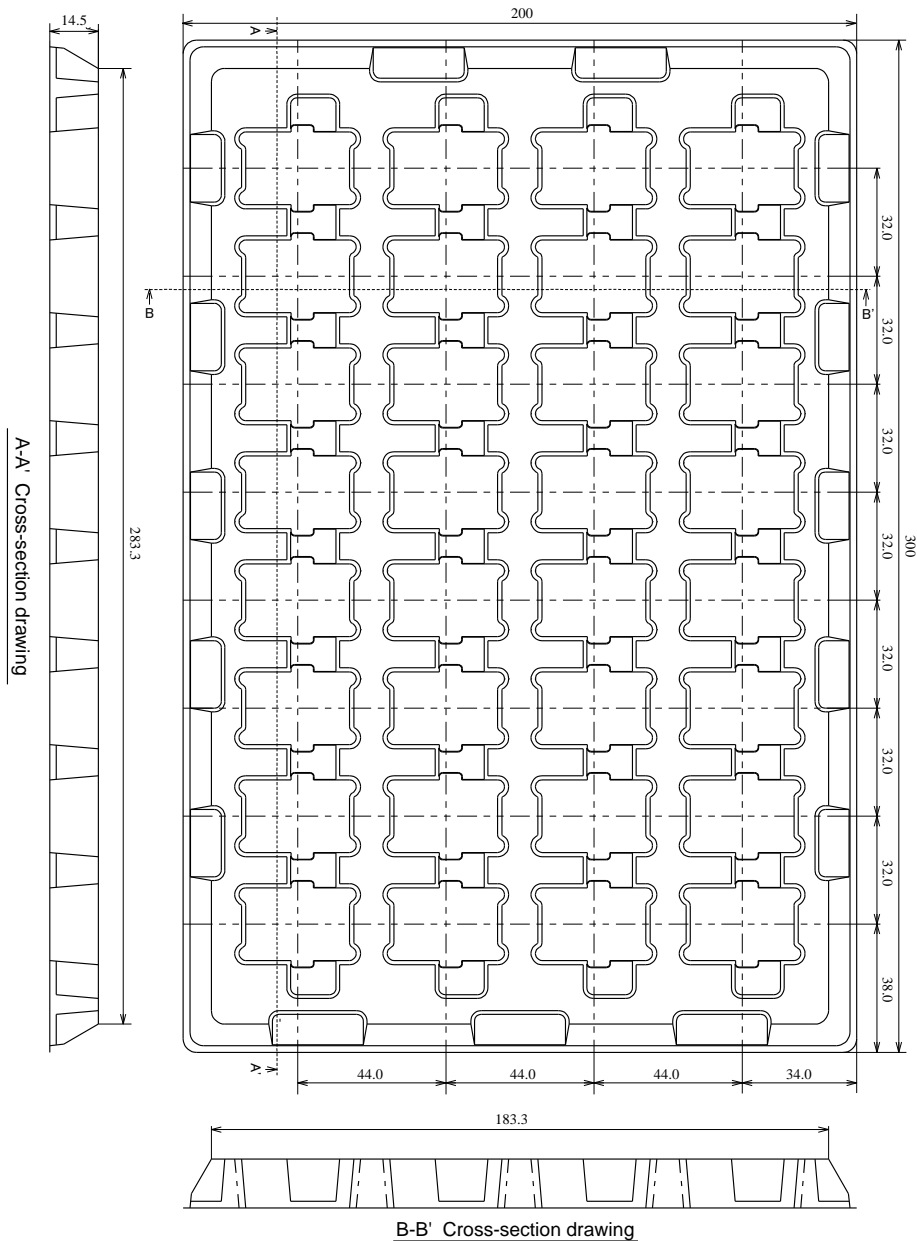

Fig.10-1

Note:

1. This datasheet is downloaded from the website of Murata Manufacturing co., ltd. Therefore, it's specifications are subject to change or our products in it may be discontinued without advance notice. Please check with our sales representatives or product engineers before ordering.
2. This datasheet has only typical specifications because there is no space for detailed specifications. Therefore, please approve our product specifications or transact the approval sheet for product specifications before ordering.

11. Production factory

Komatsu Murata Mfg.Co., Ltd.
 Kanazu Murata Mfg. Co., Ltd.
 Wakura Murata Mfg. Co., Ltd.

12. Characteristics Data

12.1.Static Electrical Characyeristics

Vin=17V~40V, Vout=5.0V

(Ta=25°C, Cin 50CE220KX × 3, Cout= 16CE330KX × 2, RVAR=Open)

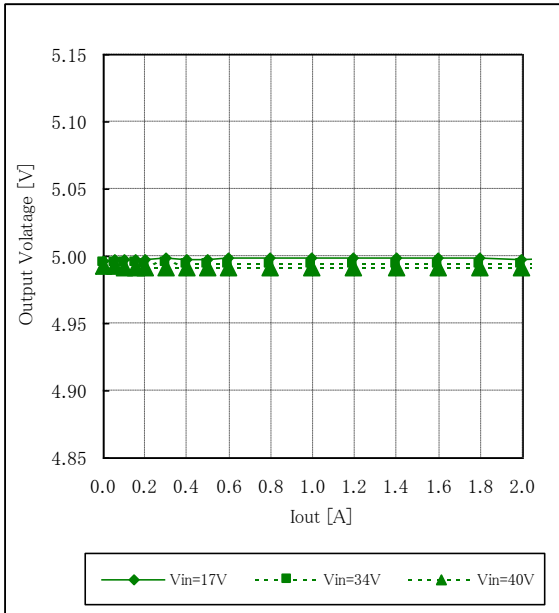

Fig.12-1-1. Output Voltage vs. Output Current

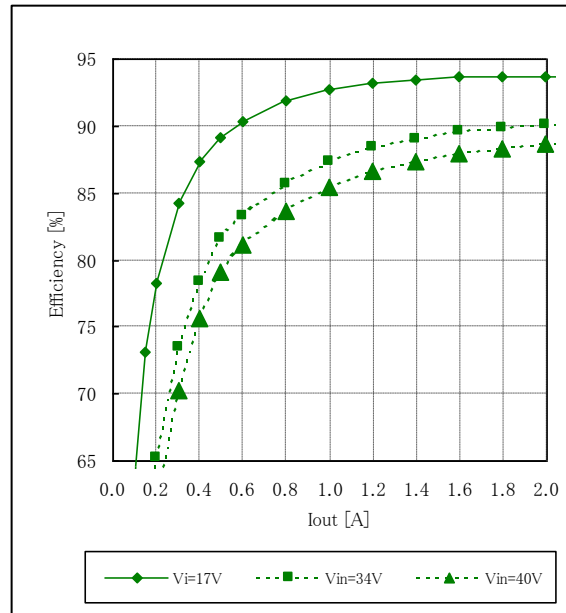

Fig.12-1-2. Efficiency vs. Output Current

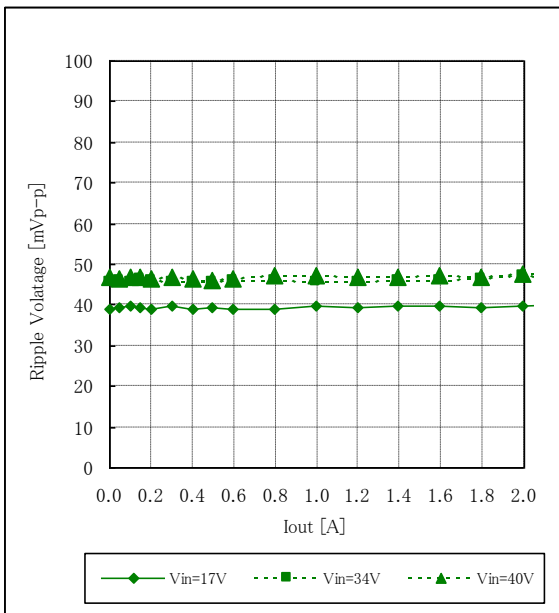

Fig.12-1-3. Ripple Voltage vs. Output Current

Note:

1. This datasheet is downloaded from the website of Murata Manufacturing co., Ltd. Therefore, it's specifications are subject to change or our products in it may be discontinued without advance notice. Please check with our sales representatives or product engineers before ordering.
2. This datasheet has only typical specifications because there is no space for detailed specifications. Therefore, please approve our product specifications or transact the approval sheet for product specifications before ordering.

Vin=17V~40V, Vout=12.0V
 (Ta=25°C, Cin 50CE220KX×3, Cout= 16CE330KX×2, RVAR=GND)

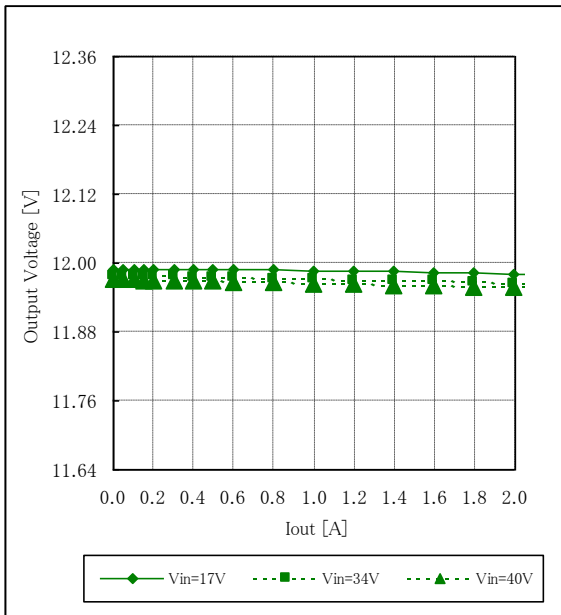

Fig.12-1-4. Output Voltage vs. Output Current

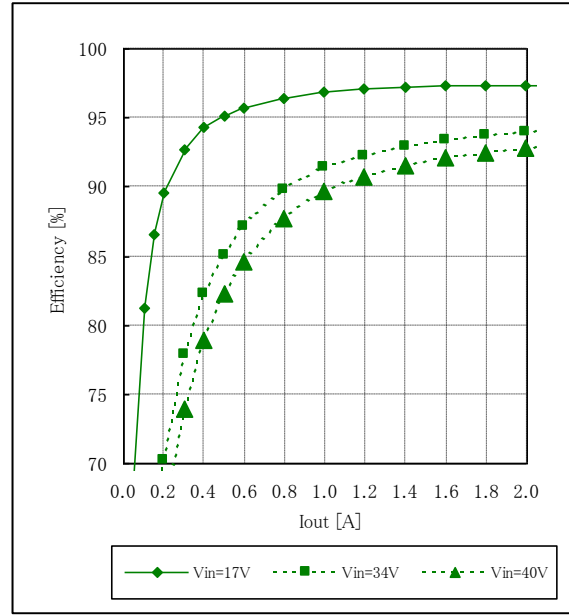

Fig.12-1-5. Efficiency vs. Output Current

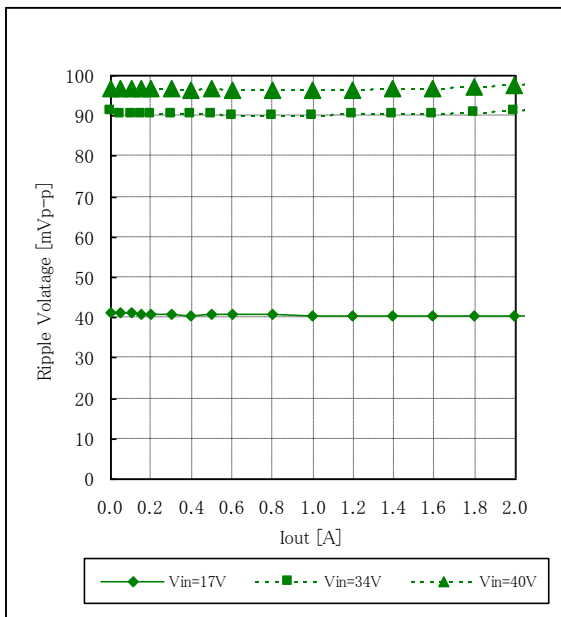

Fig.12-1-6. Ripple Voltage vs. Output Current

Note:

1. This datasheet is downloaded from the website of Murata Manufacturing co., Ltd. Therefore, it's specifications are subject to change or our products in it may be discontinued without advance notice. Please check with our sales representatives or product engineers before ordering.
2. This datasheet has only typical specifications because there is no space for detailed specifications. Therefore, please approve our product specifications or transact the approval sheet for product specifications before ordering.

12.2.Dynamic Electrical Characyeristics

Vin=17V, Vout=5.0V

(Ta=25°C, Cin 50CE220KX × 3, Cout= 16CE330KX × 2, RVAR=Open)

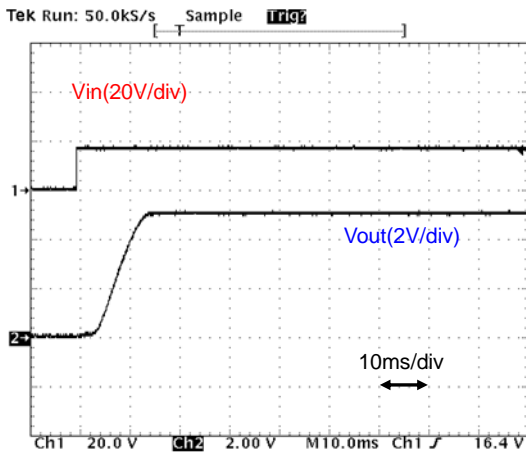

Fig.12-2-1. Start-up Waveform (Io=0A)

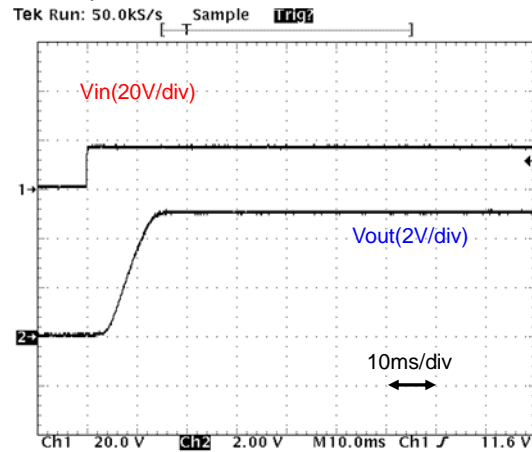

Fig.12-2-2. Start-up Waveform (Io=2A)

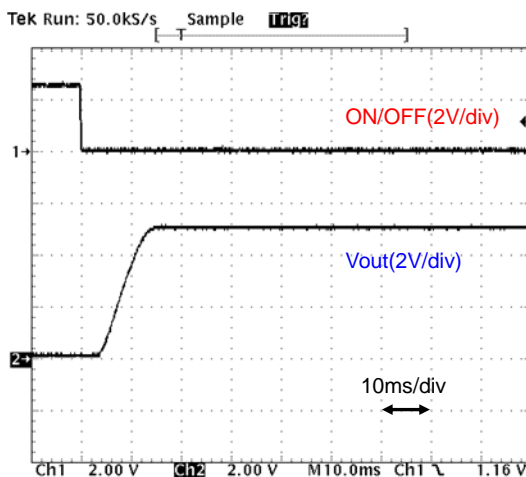

Fig.12-2-3. Start-up Waveform (Io=0A)

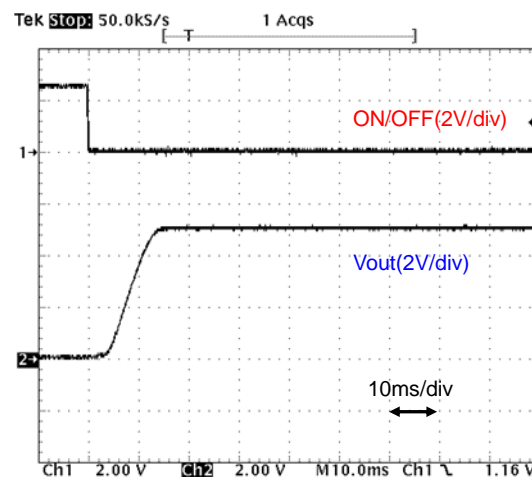

Fig.12-2-4. Start-up Waveform (Io=2A)

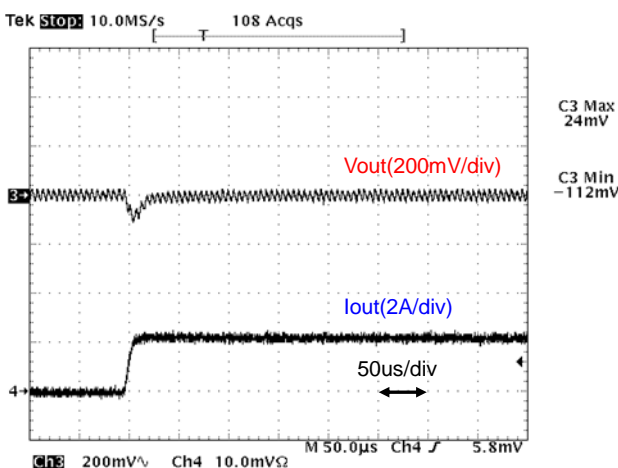

Fig.12-2-5. Load Transient Response (Io= 0 → 2A)

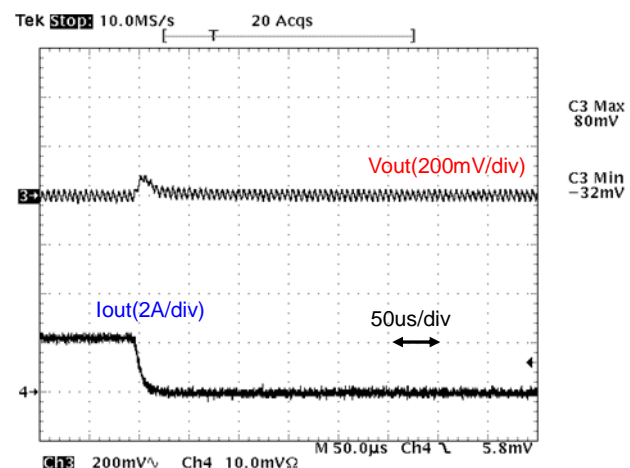

Fig.12-2-6. Load Transient Response (Io= 2A → 0)

Note:

1. This datasheet is downloaded from the website of Murata Manufacturing co., Ltd. Therefore, it's specifications are subject to change or our products in it may be discontinued without advance notice. Please check with our sales representatives or product engineers before ordering.
2. This datasheet has only typical specifications because there is no space for detailed specifications. Therefore, please approve our product specifications or transact the approval sheet for product specifications before ordering.

Vin=34V, Vout=5.0V

(Ta=25°C, Cin 50CE220KX × 3, Cout= 16CE330KX × 2, RVAR=Open)

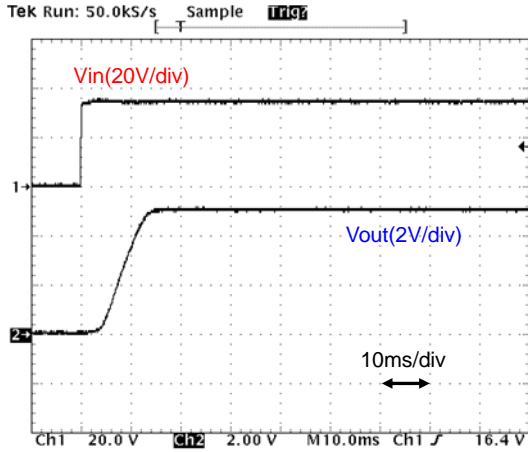

Fig.12-2-7. Start-up Waveform (Io=0A)

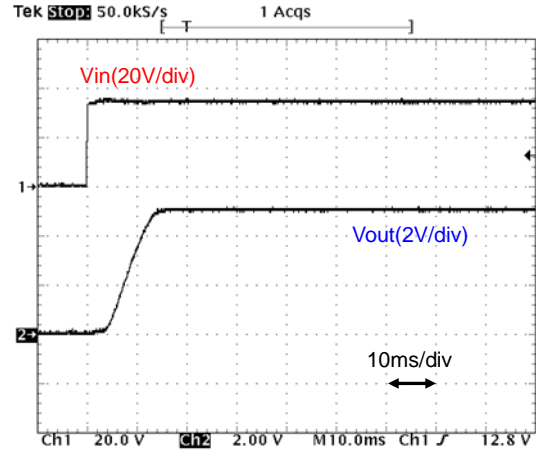

Fig.12-2-8. Start-up Waveform (Io=2A)

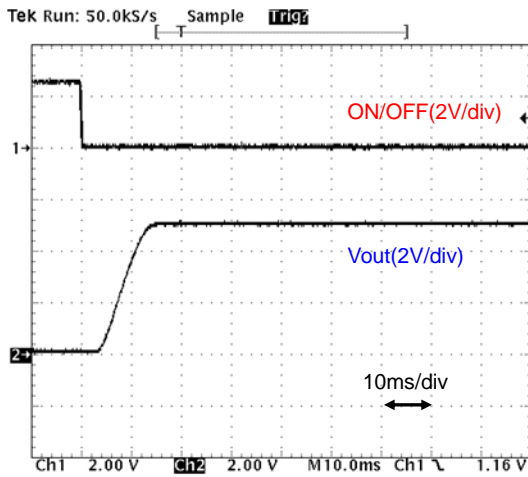

Fig.12-2-9. Start-up Waveform (Io=0A)

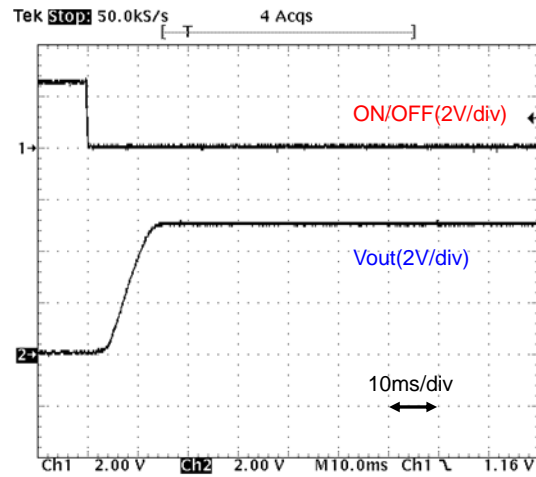

Fig.12-2-10. Start-up Waveform (Io=2A)

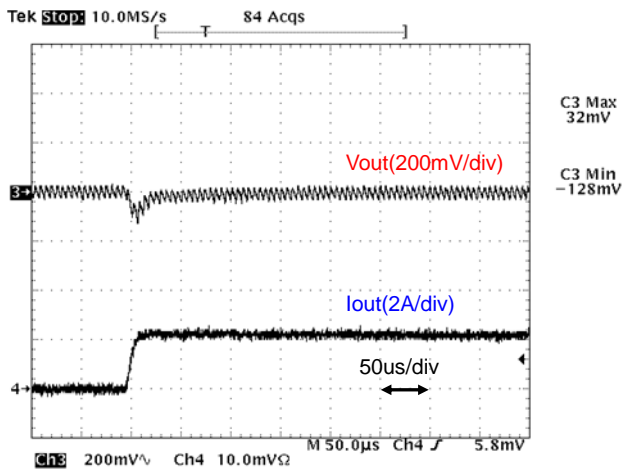

Fig.12-2-11. Load Transient Response (Io= 0 → 2A)

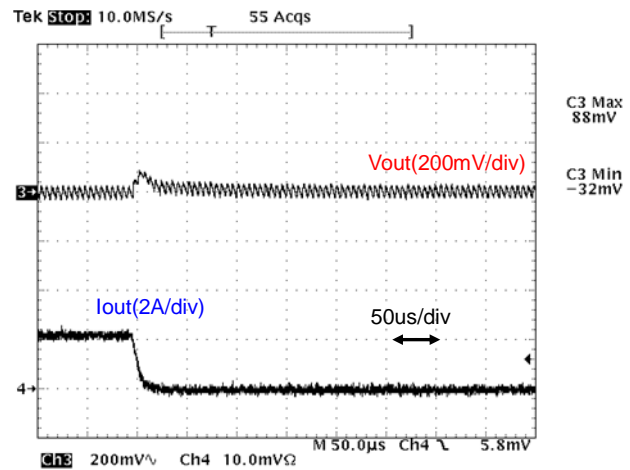

Fig.12-2-12. Load Transient Response (Io= 2A → 0)

Note:

1. This datasheet is downloaded from the website of Murata Manufacturing co., Ltd. Therefore, it's specifications are subject to change or our products in it may be discontinued without advance notice. Please check with our sales representatives or product engineers before ordering.
2. This datasheet has only typical specifications because there is no space for detailed specifications. Therefore, please approve our product specifications or transact the approval sheet for product specifications before ordering.

Vin=40V, Vout=5.0V

(Ta=25°C, Cin 50CE220KX × 3, Cout= 16CE330KX × 2, RVAR=Open)

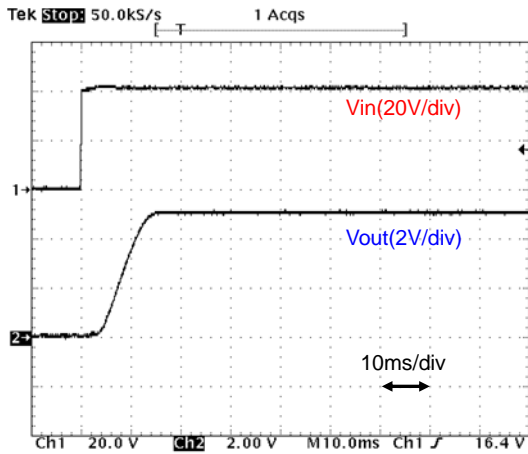

Fig.12-2-13. Start-up Waveform (Io=0A)

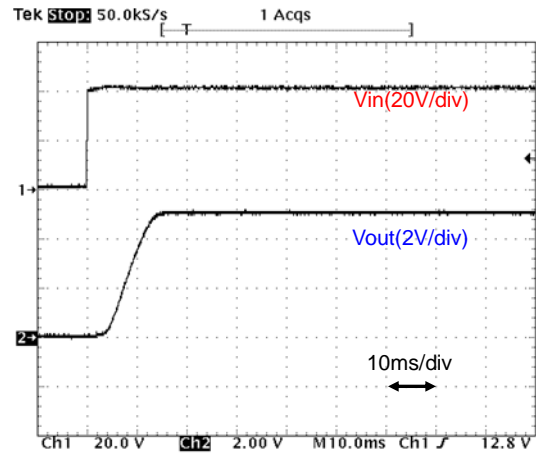

Fig.12-2-14. Start-up Waveform (Io=2A)

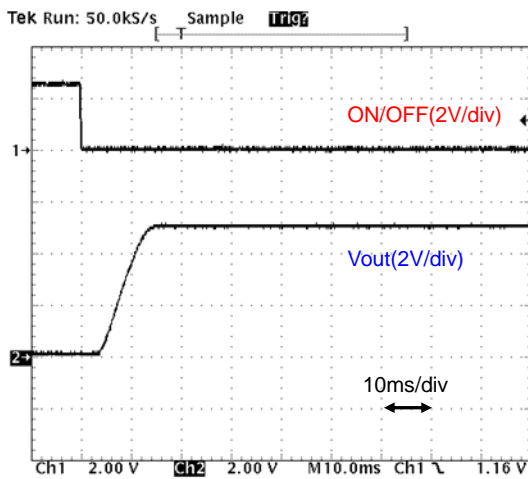

Fig.12-2-15. Start-up Waveform (Io=0A)

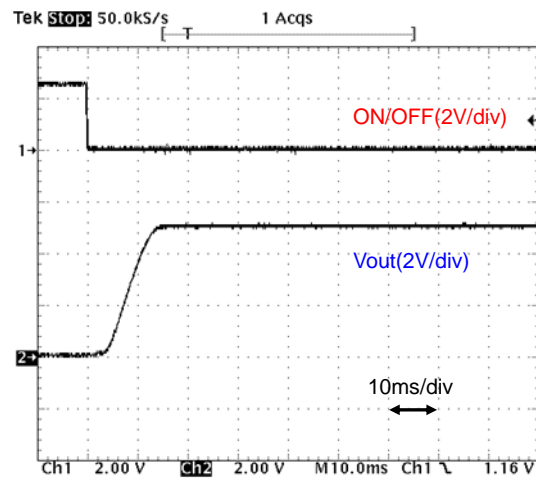

Fig.12-2-16. Start-up Waveform (Io=2A)

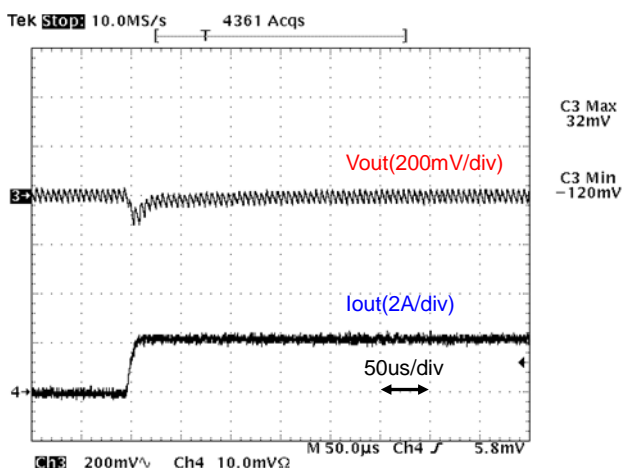

Fig.12-2-17. Load Transient Response (Io= 0 → 2A)

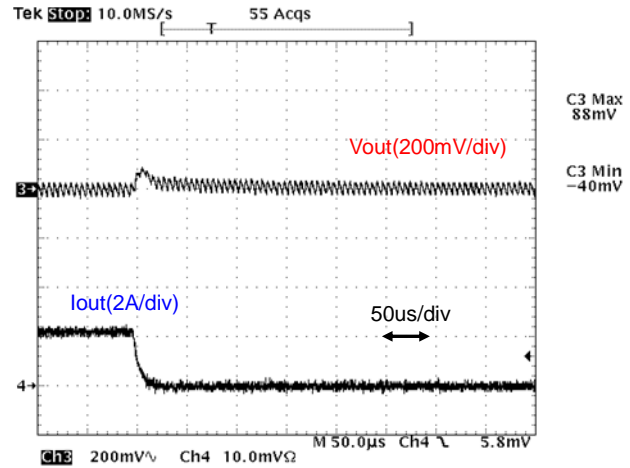

Fig.12-2-18. Load Transient Response (Io= 2A → 0)

Note:

1. This datasheet is downloaded from the website of Murata Manufacturing co., Ltd. Therefore, it's specifications are subject to change or our products in it may be discontinued without advance notice. Please check with our sales representatives or product engineers before ordering.
2. This datasheet has only typical specifications because there is no space for detailed specifications. Therefore, please approve our product specifications or transact the approval sheet for product specifications before ordering.

Vin=17V, Vout=12.0V

(Ta=25°C, Cin 50CE220KX × 3, Cout= 16CE330KX × 2, RVAR=GND)

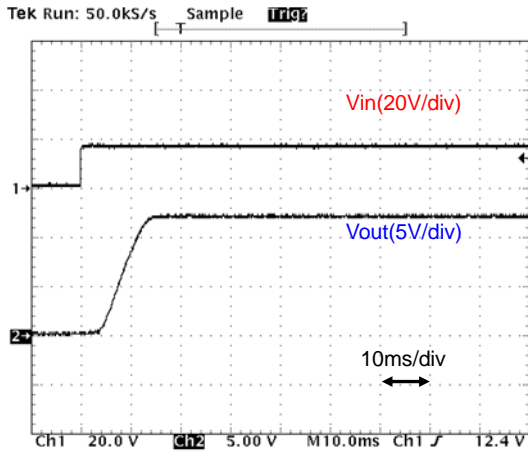

Fig.12-2-19. Start-up Waveform (Io=0A)

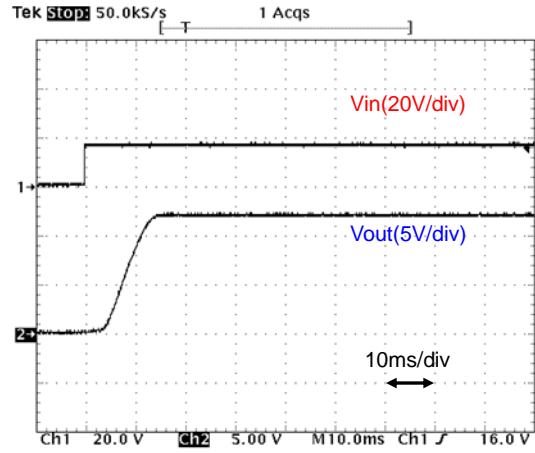

Fig.12-2-20. Start-up Waveform (Io=2A)

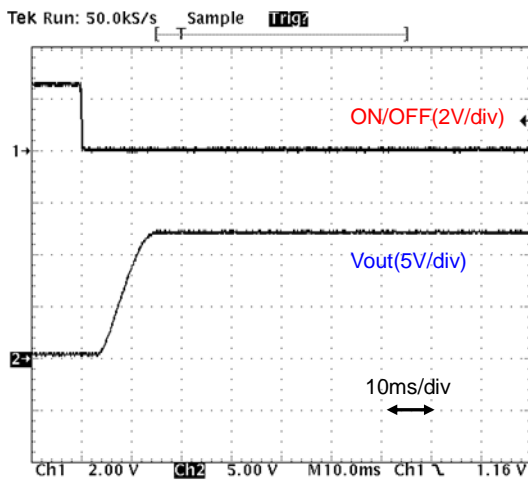

Fig.12-2-21. Start-up Waveform (Io=0A)

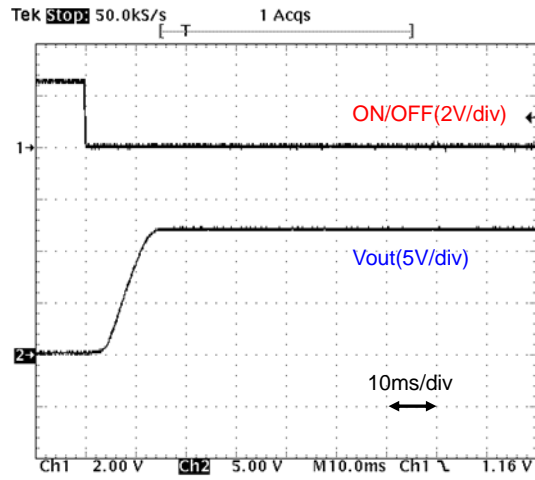

Fig.12-2-22. Start-up Waveform (Io=2A)

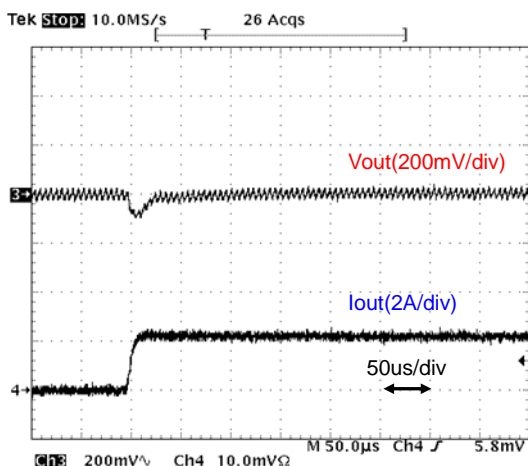

Fig.12-2-23. Load Transient Response (Io= 0 → 2A)

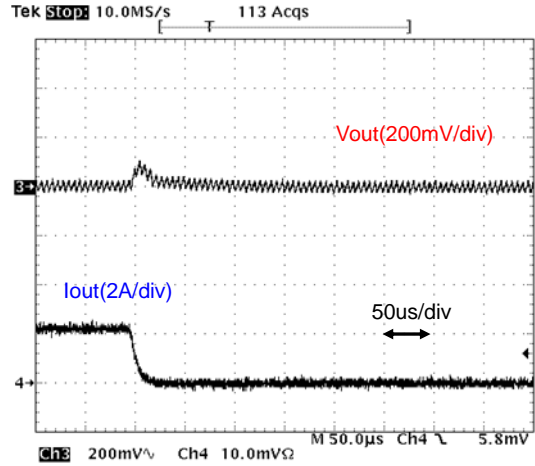

Fig.12-2-24. Load Transient Response (Io= 2A → 0)

Note:

1. This datasheet is downloaded from the website of Murata Manufacturing co., Ltd. Therefore, it's specifications are subject to change or our products in it may be discontinued without advance notice. Please check with our sales representatives or product engineers before ordering.
2. This datasheet has only typical specifications because there is no space for detailed specifications. Therefore, please approve our product specifications or transact the approval sheet for product specifications before ordering.

Vin=34V, Vout=12.0V

(Ta=25°C, Cin 50CE220KX×3, Cout= 16CE330KX×2, RVAR=GND)

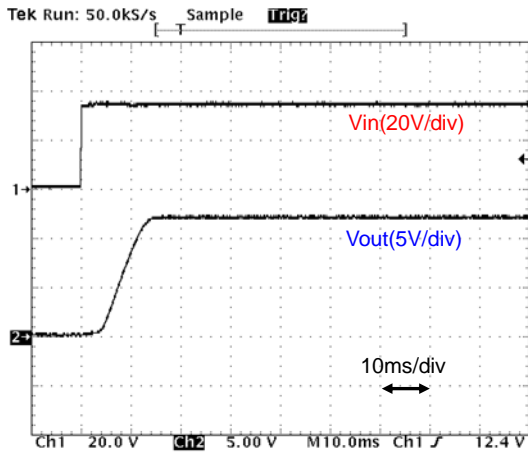

Fig.12-2-25. Start-up Waveform (Io=0A)

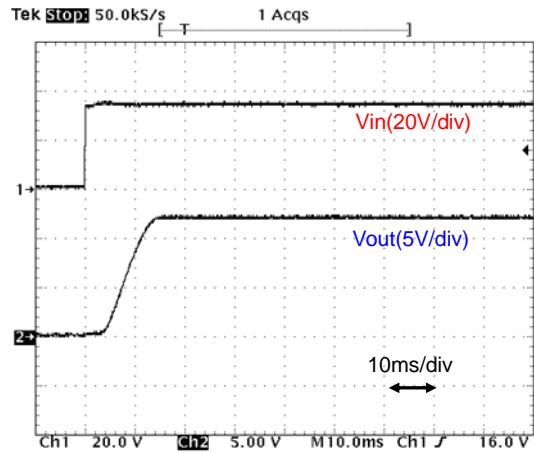

Fig.12-2-26. Start-up Waveform (Io=2A)

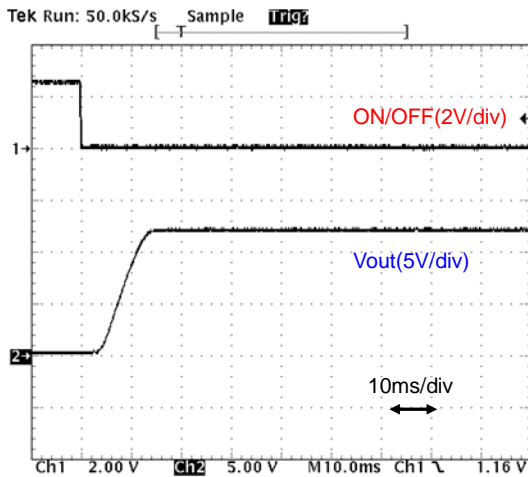

Fig.12-2-27. Start-up Waveform (Io=0A)

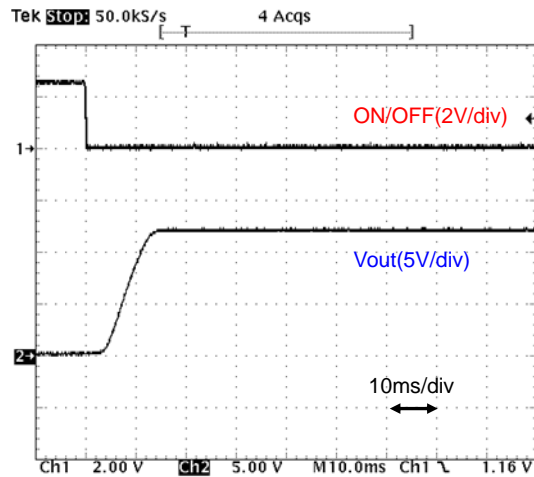

Fig.12-2-28. Start-up Waveform (Io=2A)

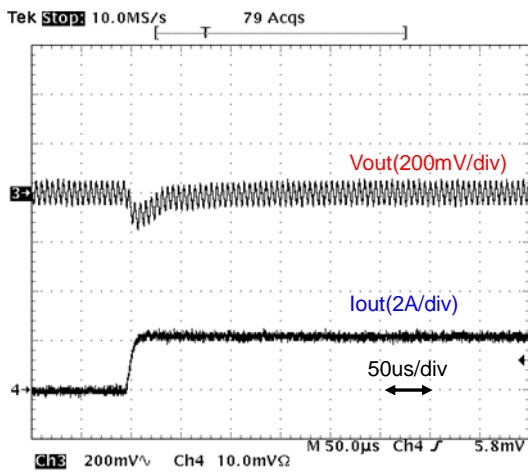

Fig.12-2-29. Load Transient Response (Io= 0 → 2A)

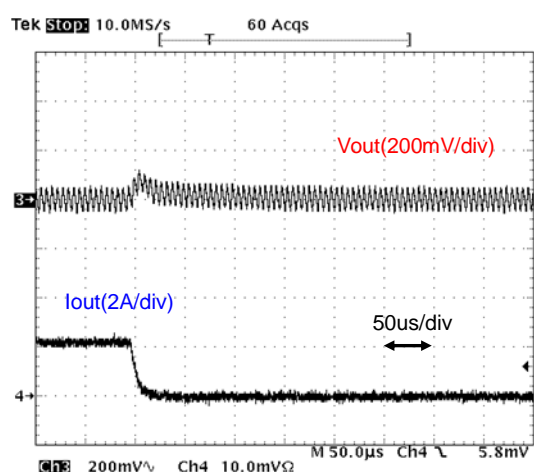

Fig.12-2-30. Load Transient Response (Io= 2A → 0)

Note:

1. This datasheet is downloaded from the website of Murata Manufacturing co., Ltd. Therefore, it's specifications are subject to change or our products in it may be discontinued without advance notice. Please check with our sales representatives or product engineers before ordering.
2. This datasheet has only typical specifications because there is no space for detailed specifications. Therefore, please approve our product specifications or transact the approval sheet for product specifications before ordering.

Vin=40V, Vout=12.0V

(Ta=25°C, Cin 50CE220KX×3, Cout= 16CE330KX×2, RVAR=GND)

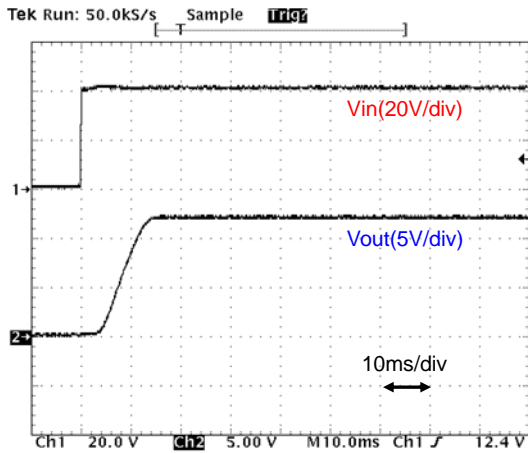

Fig.12-2-31. Start-up Waveform (Io=0A)

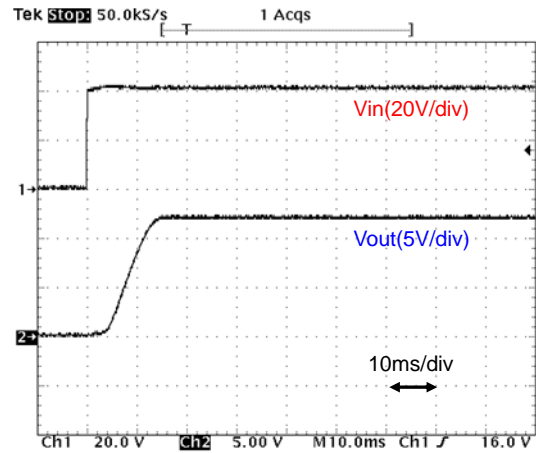

Fig.12-2-32. Start-up Waveform (Io=2A)

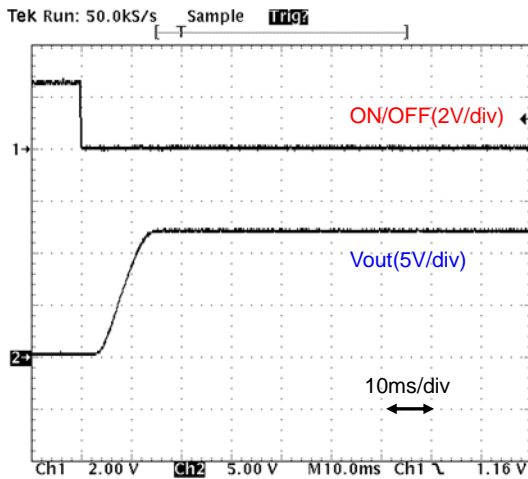

Fig.12-2-33. Start-up Waveform (Io=0A)

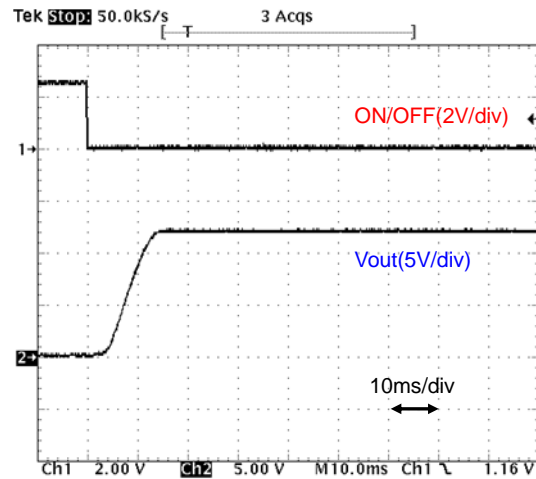

Fig.12-2-34. Start-up Waveform (Io=2A)

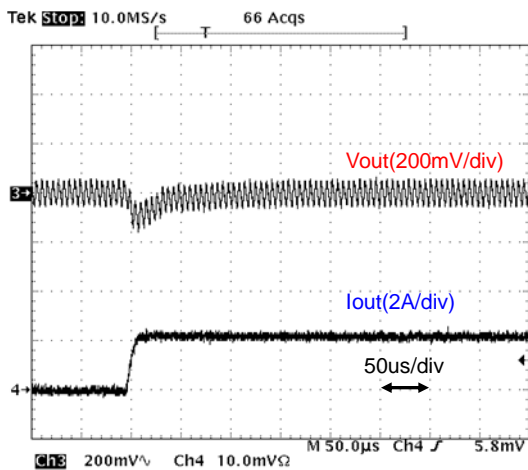

Fig.12-2-35. Load Transient Response (Io= 0 → 2A)

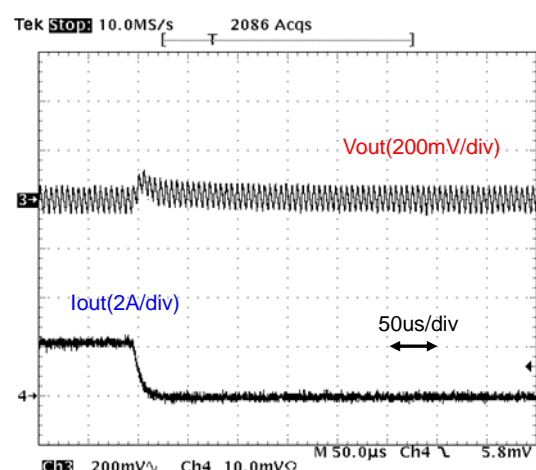
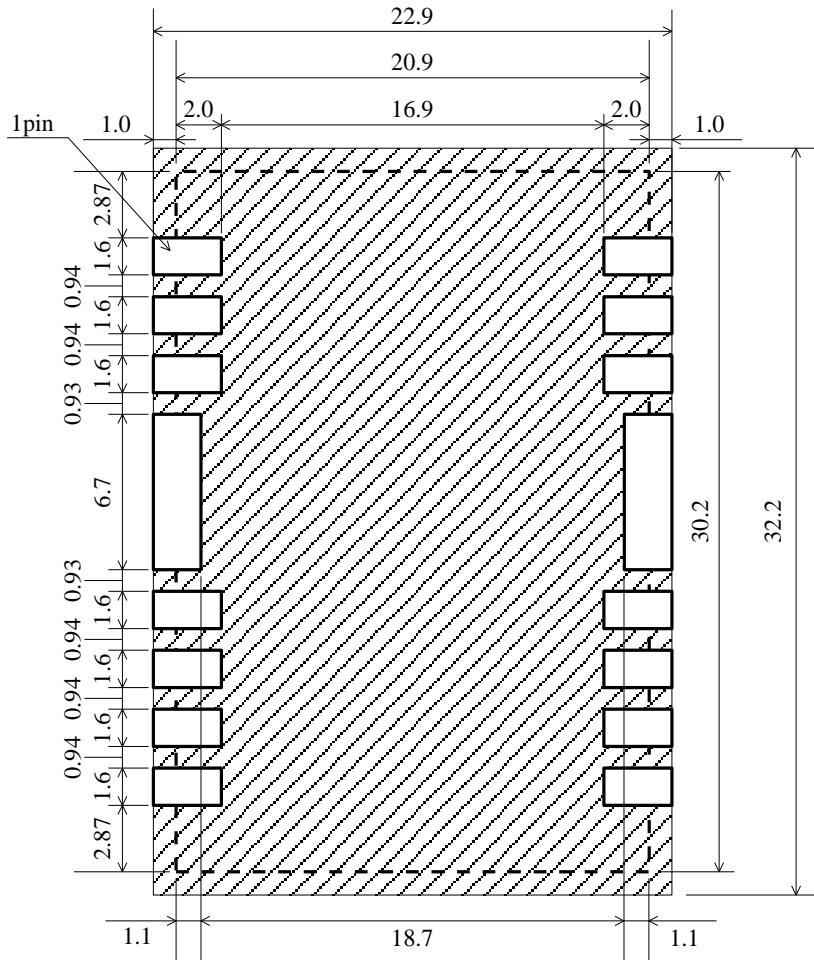



Fig.12-2-36. Load Transient Response (Io= 2A → 0)

Note:

1. This datasheet is downloaded from the website of Murata Manufacturing co., Ltd. Therefore, it's specifications are subject to change or our products in it may be discontinued without advance notice. Please check with our sales representatives or product engineers before ordering.
2. This datasheet has only typical specifications because there is no space for detailed specifications. Therefore, please approve our product specifications or transact the approval sheet for product specifications before ordering.

13. Mounting Condition
 13.1. PCB Land Pattern Recommendation



 Area prohibits wirings other than land.

There are wiring coppers or through-hole via at the bottom side of the DC-DC converter. When you design your PCBs, please be careful not to short the circuit of the DC-DC converter or PCBs.

 **Note:**

1. This datasheet is downloaded from the website of Murata Manufacturing co., ltd. Therefore, it's specifications are subject to change or our products in it may be discontinued without advance notice. Please check with our sales representatives or product engineers before ordering.
2. This datasheet has only typical specifications because there is no space for detailed specifications. Therefore, please approve our product specifications or transact the approval sheet for product specifications before ordering.

13.2. Recommendable Condition of Soldering

The following profile is recommended for the reflow of this product using Pb-free solder paste (Sn-Ag-Cu).

Method : Full convection reflow soldering

Reflow Soldering Profile
 JEDEC IPC/JEDEC J-STD-020D
 Table 5-2 Classification Reflow Profile
 Pb-Free Assembly Large Body

Profile details

| | |
|-----------------------|------------------------------------|
| Soldering temperature | : 245 °C +0/-5 °C |
| Soldering time | : 30seconds, 240 to 245 °C |
| Heating time | : 60 to 150 seconds, over 217 °C |
| Preheating time | : 60 to 120 seconds, 150 to 200 °C |
| Programming rate | : 3 °C / sec. Max., 217 to 245 °C |
| Descending rate | : 6 °C / sec. Max. |
| Total soldering time | : 8 minutes Max., 25 to 245 °C |
| Times | : 1time |

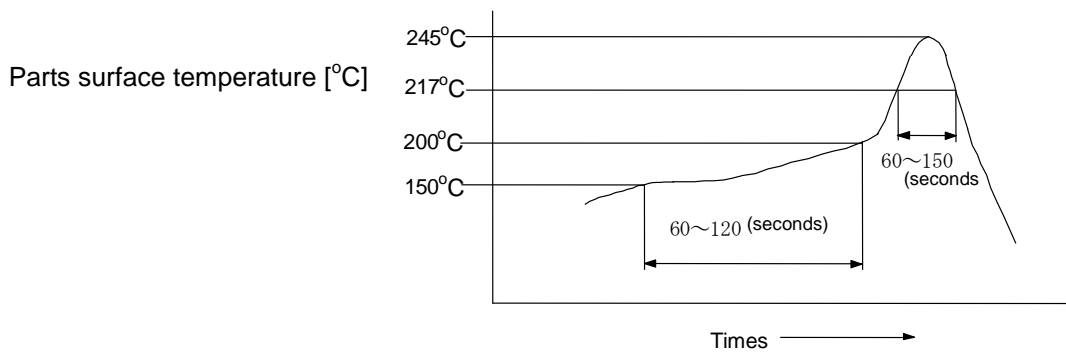

※Do not vibrate for the products on reflow.
 Please need to take care temperature control because mounted parts may come off if the product are left under the high temperature.
 Do not reflow DC-DC converter as follows, because DC-DC converter may fall down from a substrate during reflowing

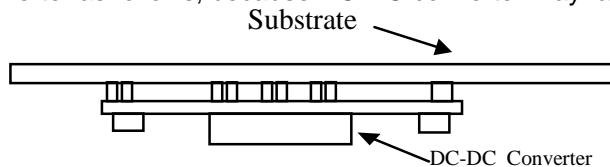

Note:

1. This datasheet is downloaded from the website of Murata Manufacturing co., ltd. Therefore, it's specifications are subject to change or our products in it may be discontinued without advance notice. Please check with our sales representatives or product engineers before ordering.
2. This datasheet has only typical specifications because there is no space for detailed specifications. Therefore, please approve our product specifications or transact the approval sheet for product specifications before ordering.

14. Notice

14. 1. Both input-side and output side, please make the wiring loop between plus and minus as small as possible. The influence of leakage inductance can be reduced.
14. 2. Please design the print pattern of the main circuit as wide and short as possible.
14. 3. Please do not use a connector or a socket for connection with your board of this product. Electrical performance may be deteriorated the influence of contact resistance. Please be sure to mount this product with solder.
14. 4. Be sure to provide an appropriate fail-safe function on your product to prevent a second damage that may be caused by the abnormal function or the failure of our product.
14. 5. Inrush current protection is not a feature of this product.
14. 6. Please connect the input terminal with proper polarity. If you connect wrong polarity, the DC-DC Converter may be broken. In the case of the DC-DC Converter is damaged, abnormal input current may flow in, and abnormal overheat of the DC-DC Converter, or some damage of your products may occur. Please use a diode and a fuse to as following figure.

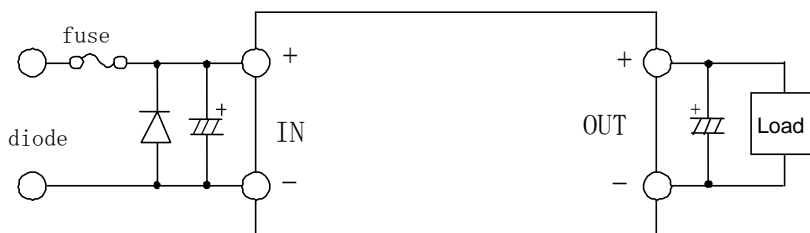

※Please select diode and fuse after confirming the operation.

14. 7 Cleaning

Please use no-cleaning type flux and do not wash this product.

14. 8 Storage

- 14.8.1. Please store the products in room where the temperature/humidity is stable and direct sunlight cannot come in, and use the products within 6 months after delivery.

Please avoid damp and heat or such places where the temperature greatly changes, as water may condense on this product, and the quality of characteristics may be reduced, and/or be the solderability may be degraded.

If this product needs to be stored for a long time (more than 1 year), this product may be degraded in solderability and/or corroded. Please test the solderability of this product regularly. Baking before reflow process is unnecessary to store the products under 30°C, 60%RH or less up to 6 months.

In case the storage condition is over above mentioned, if these are unpacked condition, please bake them at 125°C ± 5°C/24hour. If these are packed in a tape, please bake them before soldering at 60°C ± 5°C /168hour.

- 14.8.2. Please do not store this product in places such as :

A dusty place, a place exposed directly to sea breeze, or in an atmosphere containing corrosive gas (Cl₂, NH₃, SO₂, NO_x and so on).

⚠ Note:

1. This datasheet is downloaded from the website of Murata Manufacturing co., Ltd. Therefore, it's specifications are subject to change or our products in it may be discontinued without advance notice. Please check with our sales representatives or product engineers before ordering.
2. This datasheet has only typical specifications because there is no space for detailed specifications. Therefore, please approve our product specifications or transact the approval sheet for product specifications before ordering.

14. 9 Operational Environment and Operational Conditions

14. 9.1 Operational Environment

The products are not waterproof, chemical-proof or rust-proof.

In order to prevent leakage of electricity and abnormal temperature increase of the products, do not use the products under the following circumstances:

- (1) in an atmosphere containing corrosive gas (Cl₂, NH₃, SO₂, NOX and so on).
- (2) in a dusty place.
- (3) in a place exposed to direct sunlight.
- (4) in such a place where water splashes or in such a humid place where water condenses.
- (5) in a place exposed to sea breeze.
- (6) in any other places similar to the above (1)through (5).

14. 9.2 Operational Conditions

Please use the products within specified values (power supply, temperature, input, output and load condition, and so on). Input voltage drop for line impedance, so please make sure that input voltage is included in specified values.

If you use the products over the specified values, it may break the products, reduce the quality, and even if the products can endure the condition for short time, it may cause degradation of the reliability.

Also please take care that the external voltage over output voltage of DC-DC Converter does not applies to output of this DC-DC Converter.

14. 9.3 Note prior to use

If you apply high static electricity, over rated voltage or reverse voltage to the products, it may cause defects in the products or degrade the reliability.

Please avoid the following items:

- (1) over rating power supply, reverse power supply or not-enough connection of 0 V(DC) line.
- (2) electrostatic discharge by production line and/or operator.
- (3) electrified product by electrostatic induction.

Do not give an excessive mechanical shock..

If you drop the products on the floor, etc., it may occur a crack to the core of inductors and monolithic ceramic capacitors.

Do not give a strong shock such as a drop in handling.

14. 10 Transportation

If you transport the products, please pack them so that the package will not be damaged by mechanical vibration or mechanical shock, and please educate and guide a carrier to prevent rough handling.

If you transport the products to overseas (in particular, by sea), it is expected that the transportation environment will be the worst, so please pack the products, in the package designed on the consideration of mechanical strength, vibration-resistant and humidity-resistant. The package of the products which Murata sells in Japan, may not resist over seas transport.

Please consult us if you are to use the Murata package of the products sold in Japan for transport to overseas.

 Note

1. Murata recommends that customers ensure that the evaluation and testing of these devices are completed with this product actually assembled on their product.
2. Please contact our main sales office or nearby sales office before using our products for the applications listed below which require especially high reliability for the prevention of defects which might directly cause damage to the third party's life, body or property or this products for any other applications that described in the above.

- | | | |
|--|-----------------------|----------------------------|
| ① Aircraft equipment | ② Aerospace equipment | ③ Undersea equipment |
| ④ Power plant control equipment | | ⑤ Medical equipment |
| ⑥ Transportation equipment (vehicles, trains, ships, etc.) | | ⑦ Traffic signal equipment |
| ⑧ Disaster prevention /crime prevention equipment | | |
| ⑨ Data-processing equipment | | |
| ⑩ Application of similar complexity and/or reliability requirements to the applications listed in the above. | | |

This DATA Sheet is indicated in Apr. 2011. About the written contents, since changing without a preliminary announcement for improvement and supply are sometimes stopped, please confirm in case of ordering. If written contents are unknown, please ask to our main sales office or nearby sales office.

 Note:

1. This datasheet is downloaded from the website of Murata Manufacturing co., Ltd. Therefore, it's specifications are subject to change or our products in it may be discontinued without advance notice. Please check with our sales representatives or product engineers before ordering.
2. This datasheet has only typical specifications because there is no space for detailed specifications. Therefore, please approve our product specifications or transact the approval sheet for product specifications before ordering.