



Expertise Applied | Answers Delivered



PRODUCT
CATALOG
& DESIGN
GUIDE



TVS DIODE

Transient Voltage Suppression
(TVS) Diode Products

Littelfuse Circuit Protection Solutions Portfolio

Consumer Electronics | Telecom | White Goods | Medical Equipment | TVSS and Power Solutions

DESIGN SUPPORT

Live Application Design and Technical Support—Tap into our expertise. Littelfuse engineers are available around the world to help you address design challenges and develop unique, customized solutions for your products.

Product Sampling Programs—Most of our products are available as samples for testing and verification within your circuit design. Visit Littelfuse.com or contact a Littelfuse product representative for additional information.

Product Evaluation Labs and Services—Littelfuse global labs are the hub of our new product development initiatives, and also provide design and compliance support testing as an added-value to our customers.



OVERVOLTAGE SUPPRESSION TECHNOLOGIES (1-6)

1. TVS Diodes — Suppress overvoltage transients such as Electrical Fast Transients (EFT), inductive load switching and lightning in a wide variety of applications in the computer, industrial, telecom and automotive markets.

2. Varistors — Multiple forms, from Metal Oxide Varistors (MOVs) that suppress transient voltages to Multi-Layer Varistors (MLVs) designed for applications requiring protection from various transients in computers and handheld devices as well as industrial and automotive applications.

3. SIDACtor® Devices — Complete line of protection thyristor products specifically designed to suppress overvoltage transients in a broad range of telecom and datacom applications.

4. Gas Plasma Arrestors (GDTs) — Available in small footprint leaded and surface mount configurations, Littelfuse GDTs respond fast to transient overvoltage events, reducing the risk of equipment damage.

5. Silicon Protection Arrays — Designed specifically to protect analog and digital signal lines from electrostatic discharge (ESD) and other overvoltage transients.

6. PulseGuard® ESD Suppressors — Available in various surface mount form factors to protect high-speed digital lines without causing signal distortion.

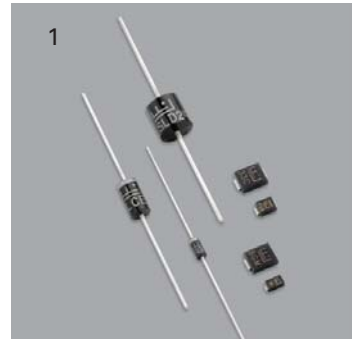

Visit

Protection folio

Supplies | Lighting | General Electronics

SWITCHING TECHNOLOGIES

Switching Thyristors— Solid-state switches used to control the flow of electrical current in applications, capable of withstanding rated blocking/off-state voltage until triggered to on-state.

ACCESSORIES

In addition to our broad portfolio of circuit protection technologies, we offer an array of **fuse holders** including circuit board, panel or in-line wire mounted devices to support a wide range of application requirements.

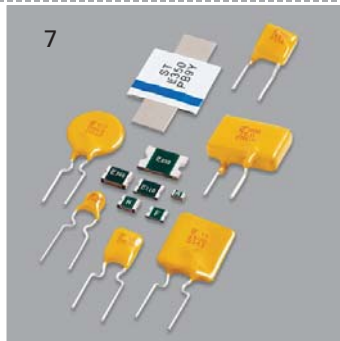
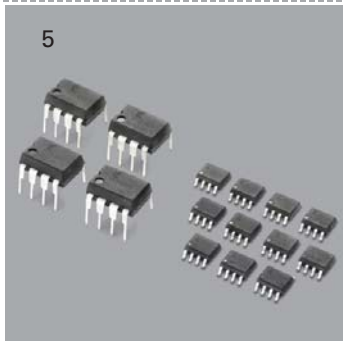
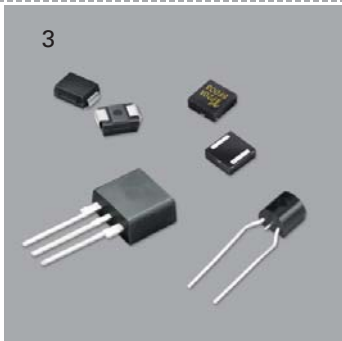
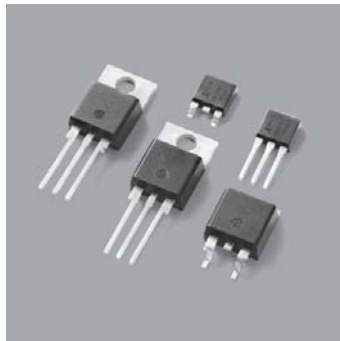

OVERCURRENT PROTECTION TECHNOLOGIES (7-8)

7. Positive Temperature Coefficient Devices (PTCs)— Provide resettable overcurrent protection for a wide range of applications.

8. Fuses— Full range including surface mount, axial, glass or ceramic, thin-film or Nano²⁰ style, fast-acting or SloBlo[®], MINI[®] and ATO[®] fuses.

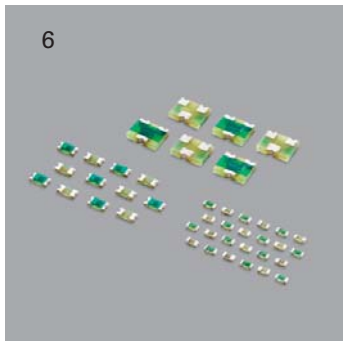
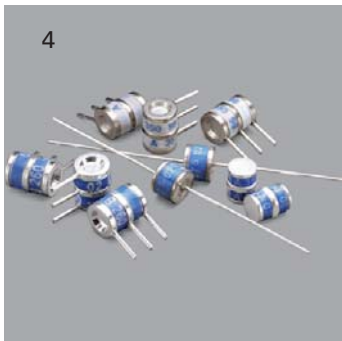

www.littelfuse.com for more information.

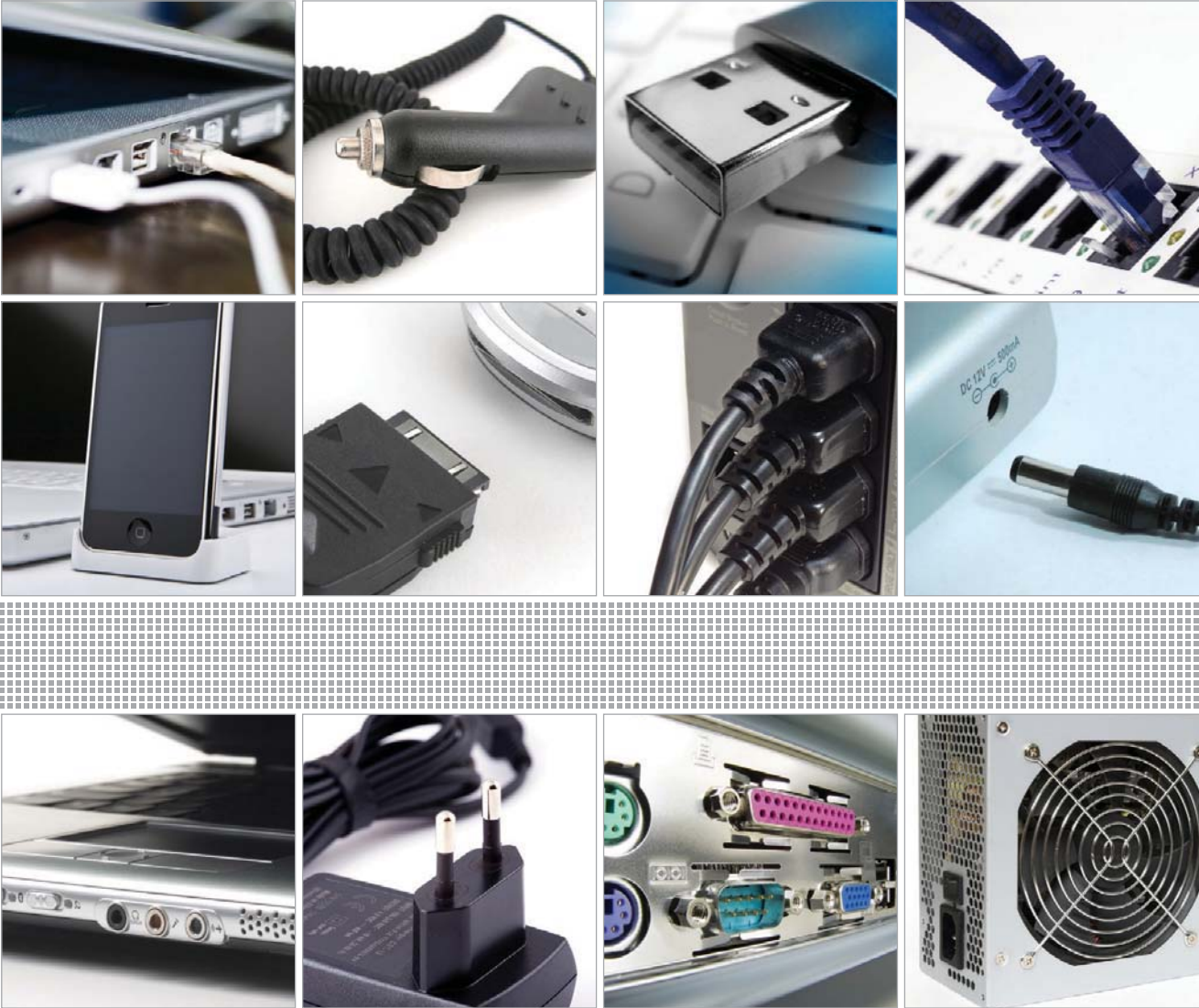

Transient Voltage Suppression (TVS) Diodes

Littelfuse offers the widest range of TVS Diodes and other circuit protection products. Littelfuse TVS Diodes are ideal for protecting semiconductor components from high-voltage transients. They can respond to overvoltage events faster than most other types of circuit protection. This makes TVS Diodes useful for protecting against very fast and often damaging voltage transients, such as lightning, inductive load switching and electrostatic discharge.

Littelfuse TVS Diodes can fit a wide range of circuit protection applications but were primarily designed to protect I/O interfaces in telecommunication and industrial equipment, computers and consumer electronics.

Features

- Low incremental surge resistance
- Unidirectional and Bidirectional polarities available
- Reverse standoff voltages range from 5 to 512V
- RoHS compliant—Matte Tin Pb-free plated
- Surface-mount power ratings from 400W to 5,000W
- Axial lead power ratings from 400W to 30,000W (30kW)
- High current protection available for 6kA and 10kA

TABLE OF CONTENTS

Overvoltage Suppression Facts..... 2
 Transient Voltage Scenarios..... 3
 TVS Diode Terms & Definitions..... 4
 TVS Diode Selection Checklist..... 4

TVS Diode Series
 Data Sheet Start Page...

Type	Surface Mount - Standard Applications (400-5000W)									
Series	SMAJ	P4SMA	SACB	SMBJ	P6SMB	1KSMB	SMCJ	1.5SMC	SMDJ	5.0SMDJ
Page #	7	13	19	23	29	35	41	45	51	57
Photo										
Operating Temperature	-85° to +302° F (-65° to +150° C)									
Package Type	DO-214AC	DO-214AC	DO-214AA	DO-214AA	DO-214AA	DO-214AA	DO-214AB	DO-214AB	DO-214AB	DO-214AB
Reverse Standoff Voltage (V _R)	5.0-440	5.8-495	5.0-50	5.0-440	5.8-495	5.8-136	5.0-440	5.8-495	5.0-170	12-170 uni-directional 12-45 bi-directional
Peak Pulse Power Range ¹ (P _{pp})	400W	400W	500W	600W	600W	1000W	1500W	1500W	3000W	5000W
Peak Pulse Current (I _{pp} 8x20µs)	Not Applicable									
Maximum Clamping Voltage (V _C)	Refer to electrical characteristics table within each series data sheet									
RoHS Compliant	Yes									
Pb Lead-Free	Yes									

Type	Axial Leaded - Standard Applications (400-5000W)								Axial Leaded - High Power				Auto	
Series	P4KE	SA	SAC	P6KE	1.5KE	LCE	3KP	5KP	15KPA	20KPA	30KPA	AK6	AK10	SLD
Page #	63	69	75	79	85	91	97	103	109	115	121	127	131	135
Photo														
Operating Temperature	-85° to +302° F (-65° to +150° C)											-67° to +347° F (-55° to +175° C)		-85° to +302° F (-65° to +150° C)
Package Type	DO-41	DO-15	DO-15	DO-15	DO-201	DO-201	P600	P600	P600	P600	P600	Radial Lead	Radial Lead	P600
Reverse Standoff Voltage (V _R)	5.8-495	5.0-180	5.0-50	5.8-512	5.8-495	6.5-90	5.0-220	5.0-250	17-280	20.0-300	28.0-288	58-430	58-430	10-24
Peak Pulse Power Range ¹ (P _{pp})	400W	500W	500W	600W	1500W	1500W	3000W	5000W	15000W	20000W	30000W	NA	NA	2200 based on 1µs/150ms pulse
Peak Pulse Current (I _{pp} 8x20µs)	Not Applicable											6000A	10000A	NA
Maximum Clamping Voltage (V _C)	Refer to electrical characteristics table within each series data sheet													
RoHS Compliant	Yes													
Pb Lead-Free	Yes													

¹ based on 10/1000µs pulse unless stated otherwise

Overvoltage Suppression Facts

Transient Threats – What Are Transients?

Voltage Transients are defined as short duration surges of electrical energy and are the result of the sudden release of energy previously stored or induced by other means, such as heavy inductive loads or lightning. In electrical or electronic circuits, this energy can be released in a predictable manner via controlled switching actions, or randomly induced into a circuit from external sources.

Repeatable transients are frequently caused by the operation of motors, generators, or the switching of reactive circuit components. Random transients, on the other hand, are often caused by Lightning and Electrostatic Discharge (ESD). Lightning and ESD generally occur unpredictably, and may require elaborate monitoring to be accurately measured, especially if induced at the circuit board level. Numerous electronics standards groups have analyzed transient voltage occurrences using accepted monitoring or testing methods. The key characteristics of several transients are shown in the table below.

	VOLTAGE	CURRENT	RISE-TIME	DURATION
Lighting	25kV	20kA	10 μ s	1ms
Switching	600V	500A	50 μ s	500ms
EMP	1kV	10A	20ns	1ms
ESD	15kV	30A	<1ns	100ns

Table 1. Examples of transient sources and magnitude

Characteristics of Transient Voltage Spikes

Transient voltage spikes generally exhibit a “double exponential” wave, as shown below for lightning and ESD.

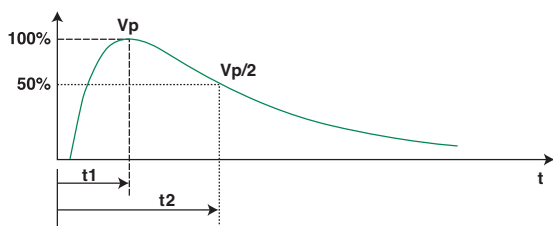

Figure 1. Lightning Transient Waveform

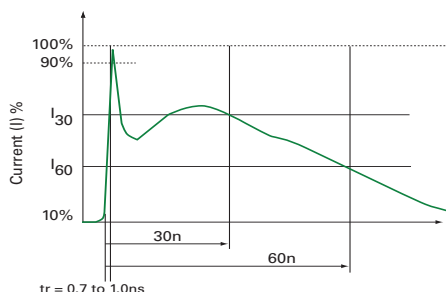

Figure 2. ESD Test Waveform

The exponential rise time of lightning is in the range 1.2 μ sec to 10 μ sec (essentially 10% to 90%) and the duration is in the range of 50 μ sec to 1000 μ sec (50% of peak values). ESD on the other hand, is a much shorter duration event. The rise time has been characterized at less than 1.0ns. The overall duration is approximately 100ns.

Why are Transients of Increasing Concern?

Component miniaturization has resulted in increased sensitivity to electrical stresses. Microprocessors for example, have structures and conductive paths which are unable to handle high currents from ESD transients. Such components operate at very low voltages, so voltage disturbances must be controlled to prevent device interruption and latent or catastrophic failures.

Sensitive microprocessors are prevalent today in a wide range of devices. Everything from home appliances, such as dishwashers, to industrial controls and even toys use microprocessors to improve functionality and efficiency.

Most vehicles now also employ multiple electronic systems to control the engine, climate, braking and, in some cases, steering, traction and safety systems.

Many of the sub- or supporting components (such as electric motors or accessories) within appliances and automobiles present transient threats to the entire system.

Careful circuit design should not only factor environmental scenarios but also the potential effects of these related components. Table 2 below shows the vulnerability of various component technologies.

Device Type	Vulnerability (volts)
VMOS	30-1800
MOSFET	100-200
GaAsFET	100-300
EPROM	100
JFET	140-7000
CMOS	250-3000
Schottky Diodes	300-2500
Bipolar Transistors	380-7000
SCR	680-1000

Table 2: Range of device vulnerability.

Transient Voltage Scenarios

Electrostatic Discharge (ESD)

Electrostatic discharge is characterized by very fast rise times and very high peak voltages and currents. This energy is the result of an imbalance of positive and negative charges between objects.

ESD that is generated by everyday activities can far surpass the vulnerability threshold of standard semiconductor technologies. Following are a few examples:

- **Walking across a carpet:**
35kV @ RH = 20%; 1.5kV @ RH = 65%
- **Walking across a vinyl floor:**
12kV @ RH = 20%; 250V @ RH = 65%
- **Worker at a bench:**
6kV @ RH = 20%; 100V @ RH = 65%
- **Vinyl envelopes:**
7kV @ RH = 20%; 600V @ RH = 65%
- **Poly bag picked up from desk:**
20kV @ RH = 20%; 1.2kV @ RH = 65%

Lightning Induced Transients

Even though a direct strike is clearly destructive, transients induced by lightning are not the result of a direct strike.

When a lightning strike occurs, the event creates a magnetic field which can induce transients of large magnitude in nearby electrical cables.

A cloud-to-cloud strike will effect not only overhead cables, but also buried cables. Even a strike 1 mile distant (1.6km) can generate 70 volts in electrical cables.

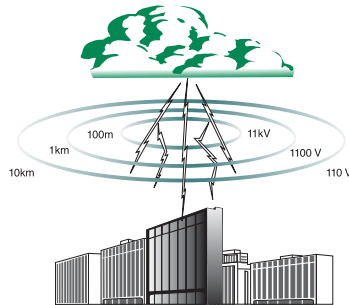

In a cloud-to-ground strike (as shown at right) the transient-generating effect is far greater.

This diagram shows a typical current waveform for induced lightning disturbances.

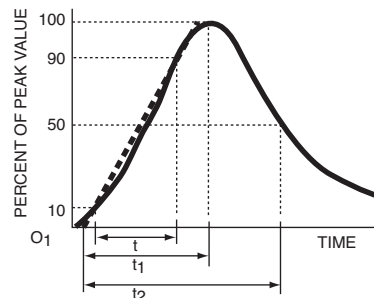

Inductive Load Switching

The switching of inductive loads generates high energy transients which increase in magnitude with increasingly heavy loads. When the inductive load is switched off, the collapsing magnetic field is converted into electrical energy which takes the form of a double exponential transient. Depending on the source, these transients can be as large as hundreds of volts and hundreds of Amps, with duration times of 400 milliseconds.

Typical sources of inductive transients include:

- **Generator**
- **Motor**
- **Relay**
- **Transformer**

These examples are common in electrical and electronic systems. Because the sizes of the loads vary according to the application, the wave shape, duration, peak current and peak voltage are all variables which exist in real world transients. Once these variables can be approximated, a suitable suppressor technology can be selected.

The diagram at right shows a transient which is the result of stored energy within the alternator of an automobile charging system.

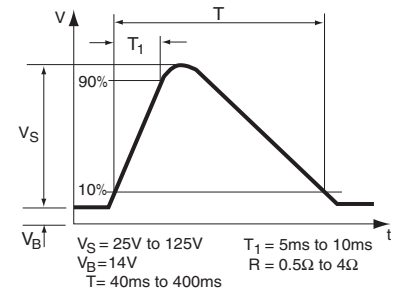

A similar transient can also be caused by other DC motors in a vehicle. For

example, DC motors power amenities such as power locks, seats and windows. These various applications of a DC motor can produce transients that are just as harmful to the sensitive electronic components as transients created in the external environment.

TVS Diode Terms & Definitions

Crowbar Device

The class of suppressors that exhibit a “crowbar” characteristic is usually associated with 4-layer NPNP silicon bipolar devices or gas plasma/GDT devices. Upon reaching a threshold or breakover voltage, further increase in current flow will cause the device to rapidly conduct with only a few volts of forward drop. In essence, the line is momentarily “short-circuited” during the transient event.

Operating Temperature Range

The minimum and maximum ambient operating temperature of the circuit in which a device will be applied. Operating temperature does not allow for the effects of adjacent components, this is a parameter the designer must take into consideration.

Capacitance

The property of a circuit element that permits it to store an electrical charge. In circuit protection, the off-state capacitance is typically measured at 1 MHz with a 2V bias applied.

Reverse Standoff Voltage (V_R)

In the case of a uni-directional TVS diode, this is the maximum peak voltage that may be applied in the ‘blocking direction’ with no significant current flow. In the case of a bi-directional transient, it applies in either direction. It is the same definition as Maximum Off-state Voltage and Maximum Working Voltage.

Breakdown Voltage (V_{BR})

Breakdown voltage measured at a specified DC test current, typically 1mA. Usually a minimum and maximum is specified.

Peak Pulse Current (I_{PP})

Maximum pulse current which can be applied repetitively. Usually a 10x1000µs double exponential waveform, but can also be 8x20µs, if stated.

Maximum Clamping Voltage (V_C or V_{CL})

Maximum voltage which can be measured across the protector when subjected to the Maximum Peak Pulse Current.

Peak Pulse Power (P_{PP})

Expressed in Watts or Kilowatts, for a 1ms exponential transient (see figure 1, page 23) it is I_{PP} multiplied by V_{CL} .

TVS Diode Selection Checklist

1. Define Circuit Operating Parameters

Normal operating voltage type in DC or AC: _____

Device Type Required: Uni-directional Bi-directional

Normal operating voltage in volts: _____

Maximum transient current (I_{PP}): _____

Maximum clamping voltage (V_C): _____

Required peak reverse surge power rating: _____

Product mounting type (package): _____

Operating temperature: _____

2. Narrow TVS Diode Series for the Application

Please refer to the product selection charts and data sheets within this guide, factoring these key parameters:

Reverse Standoff Voltage (V_R):

The device V_R should be equal to, or greater than, the peak operating level of the circuit (or part of the circuit) to be protected. This is to ensure that TVS Diode does not clip the circuit drive voltage.

Peak Pulse Current (I_{PP}):

The Peak Pulse Current (I_{PP}) identifies the maximum current the TVS Diode can withstand without damage. The required I_{PP} can only be determined by dividing the peak transient voltage by the source impedance. Note that the TVS Diode failure mechanism is a short circuit; if the TVS Diode fails due to a transient, the circuit will still be protected.

Maximum Clamping Voltage (V_C):

This is the peak voltage that will appear across the TVS Diode when subjected to the Peak Pulse Current (I_{PP}), based on 10X1000µs exponential waveform. The V_C of each TVS Diode is identified in each series data sheet electrical characteristics table.

3. Verify Ambient Operating Parameters

Ensure that the application voltage is less than or equal to the device’s standoff voltage, and that the operating temperature limits are within those specified by the device.











4. Verify Device Mounting Style and Dimensions









Please refer to the dimension drawings contained within the data sheet of each series.





5. Test the Selected Device in Actual Application

Please contact Littelfuse if you would like assistance with testing and verifying suitability of a Littelfuse device within your product. We have extensive product testing lab capabilities and technical expertise to assist you.

Data Sheet Table of Contents

Surface Mount - Standard Applications (400 - 5000W)		
	SMAJ series, Surface Mount - 400W	7
	P4SMA series, Surface Mount - 400W	13
	SACB series, Surface Mount - 500W	19
	SMBJ series, Surface Mount - 600W	23
	P6SMB series, Surface Mount - 600W	29
	1KSMB series, Surface Mount - 1000W	35
	SMCJ series, Surface Mount - 1500W	41
	1.5SMC series, Surface Mount - 1500W	45
	SMDJ series, Surface Mount - 3000W	51
	5.0SMDJ series, Surface Mount - 5000W	57

Axial Leaded - Standard Applications (400 - 5000W)		
	P4KE series, Axial Leaded - 400W	63
	SA series, Axial Leaded - 500W	69
	SAC series, Axial Leaded - 500W	75
	P6KE series, Axial Leaded - 600W	79
	1.5KE series, Axial Leaded - 1500W	85
	LCE series, Axial Leaded - 1500W	91
	3KP series, Axial Leaded - 3000W	97
	5KP series, Axial Leaded - 5000W	103

Axial Leaded - High Power Applications (15000 - 30000W and 6 - 10kA)		
	15KPA series, Axial Leaded - 15000W	109
	20KPA series, Axial Leaded - 20000W	115
	30KPA series, Axial Leaded - 30000W	121
	AK6 series, Axial Leaded - 6kA	127
	AK10 series, Axial Leaded - 10kA	131

Axial Leaded - Automotive Applications		
	SLD series, Axial Leaded - 2200W	135

RoHS SMAJ Series



Agency Approvals

AGENCY	AGENCY FILE NUMBER
	E230531

Maximum Ratings and Thermal Characteristics ($T_A=25^\circ\text{C}$ unless otherwise noted)

Parameter	Symbol	Value	Unit
Peak Pulse Power Dissipation at $T_A=25^\circ\text{C}$ by 10x1000 μs waveform (Fig.1)(Note 1), (Note 2)	P_{PPM}	400	W
Power Dissipation on infinite heat sink at $T_A=50^\circ\text{C}$	$P_{M(AV)}$	3.3	W
Peak Forward Surge Current, 8.3ms Single Half Sine Wave (Note 3)	I_{FSM}	40	A
Maximum Instantaneous Forward Voltage at 25A for Unidirectional only (Note 4)	V_F	3.5V/6.5	V
Operating Junction and Storage Temperature Range	T_J, T_{STG}	-65 to 150	$^\circ\text{C}$
Typical Thermal Resistance Junction to Lead	$R_{\theta JL}$	30	$^\circ\text{C/W}$
Typical Thermal Resistance Junction to Ambient	$R_{\theta JA}$	120	$^\circ\text{C/W}$

Notes:

1. Non-repetitive current pulse, per Fig.3 and derated above $T_A=25^\circ\text{C}$ per Fig. 2.
2. Mounted on 5.0x5.0mm copper pad to each terminal.
3. Measured on 8.3ms single half sine wave or equivalent square wave for unidirectional device only.
4. $V_F < 3.5\text{V}$ for $V_{BR} \leq 200\text{V}$ and $V_F < 6.5\text{V}$ for $V_{BR} \geq 201\text{V}$.

Description

The SMAJ series is designed specifically to protect sensitive electronic equipment from voltage transients induced by lightning and other transient voltage events.

Features

- RoHS compliant
- For surface mounted applications to optimize board space
- Low profile package
- Built-in strain relief
- Glass passivated junction
- Low inductance
- Excellent clamping capability
- 400W Peak Pulsepower capability at 10 x 1000 μs waveform, repetition rate (duty cycle): 0.01 %
- Fast response time: typically less than 1.0ps from 0 Volts to V_{BR} min
- Typical I_R less than 1 μA above 12V
- High temperature soldering: 260 $^\circ\text{C}/40$ seconds at terminals
- Typical maximum temperature coefficient delta $V_{BR} = 0.1\% \times V_{BR}$ @ 25 $^\circ\text{C}$
- Plastic package has Underwriters Laboratory Flammability 94V-O
- Matte Tin Lead-free Plated

Applications

TVS diodes are ideal for the protection of I/O Interfaces, V_{CC} bus and other vulnerable circuits used in Telecom, Computer, Industrial and Consumer electronic applications.

Electrical Characteristics

Part Number (Uni)	Part Number (Bi)	Marking		Reverse Stand off Voltage V_R (Volts)	Breakdown Voltage V_{BR} (Volts) @ I_T		Test Current I_T (mA)	Maximum Clamping Voltage V_C @ I_{PP} (V)	Maximum Peak Pulse Current I_{PP} (A)	Maximum Reverse Leakage I_R @ V_R (μ A)	Agency Approval 
		UNI	BI		MIN	MAX					
SMAJ5.0A	SMAJ5.0CA	AE	WE	5.0	6.40	07.00	10	9.2	43.5	800	X
SMAJ6.0A	SMAJ6.0CA	AG	WG	6.0	6.67	07.37	10	10.3	38.8	800	X
SMAJ6.5A	SMAJ6.5CA	AK	WK	6.5	7.22	7.98	10	11.2	35.7	500	X
SMAJ7.0A	SMAJ7.0CA	AM	WM	7.0	7.78	8.60	10	12.0	33.3	200	X
SMAJ7.5A	SMAJ7.5CA	AP	WP	7.5	8.33	9.21	1	12.9	31.0	100	X
SMAJ8.0A	SMAJ8.0CA	AR	WR	8.0	8.89	9.83	1	13.6	29.4	50	X
SMAJ8.5A	SMAJ8.5CA	AT	WT	8.5	9.44	10.40	1	14.4	27.8	20	X
SMAJ9.0A	SMAJ9.0CA	AV	VV	9.0	10.00	11.10	1	15.4	26.0	10	X
SMAJ10A	SMAJ10CA	AX	WX	10.0	11.10	12.30	1	17.0	23.5	5	X
SMAJ11A	SMAJ11CA	AZ	WZ	11.0	12.20	13.50	1	18.2	22.0	1	X
SMAJ12A	SMAJ12CA	BE	XE	12.0	13.30	14.70	1	19.9	20.1	1	X
SMAJ13A	SMAJ13CA	BG	XG	13.0	14.40	15.90	1	21.5	18.6	1	X
SMAJ14A	SMAJ14CA	BK	XK	14.0	15.60	17.20	1	23.2	17.2	1	X
SMAJ15A	SMAJ15CA	BM	XM	15.0	16.70	18.50	1	24.4	16.4	1	X
SMAJ16A	SMAJ16CA	BP	XP	16.0	17.80	19.70	1	26.0	15.4	1	X
SMAJ17A	SMAJ17CA	BR	XR	17.0	18.90	20.90	1	27.6	14.5	1	X
SMAJ18A	SMAJ18CA	BT	XT	18.0	20.00	22.10	1	29.2	13.7	1	X
SMAJ20A	SMAJ20CA	BV	XV	20.0	22.20	24.50	1	32.4	12.3	1	X
SMAJ22A	SMAJ22CA	BX	XX	22.0	24.40	26.90	1	35.5	11.3	1	X
SMAJ24A	SMAJ24CA	BZ	XZ	24.0	26.70	29.50	1	38.9	10.3	1	X
SMAJ26A	SMAJ26CA	CE	YE	26.0	28.90	31.90	1	42.1	9.5	1	X
SMAJ28A	SMAJ28CA	CG	YG	28.0	31.10	34.40	1	45.4	8.8	1	X
SMAJ30A	SMAJ30CA	CK	YK	30.0	33.30	36.80	1	48.4	8.3	1	X
SMAJ33A	SMAJ33CA	CM	YM	33.0	36.70	40.60	1	53.3	7.5	1	X
SMAJ36A	SMAJ36CA	CP	YP	36.0	40.00	44.20	1	58.1	6.9	1	X
SMAJ40A	SMAJ40CA	CR	YR	40.0	44.40	49.10	1	64.5	6.2	1	X
SMAJ43A	SMAJ43CA	CT	YT	43.0	47.80	52.80	1	69.4	5.8	1	X
SMAJ45A	SMAJ45CA	CV	YV	45.0	50.00	55.30	1	72.7	5.5	1	X
SMAJ48A	SMAJ48CA	CX	YX	48.0	53.30	58.90	1	77.4	5.2	1	X
SMAJ51A	SMAJ51CA	CZ	YZ	51.0	56.70	62.70	1	82.4	4.9	1	X
SMAJ54A	SMAJ54CA	RE	ZE	54.0	60.00	66.30	1	87.1	4.6	1	X
SMAJ58A	SMAJ58CA	RG	ZG	58.0	64.40	71.20	1	93.6	4.3	1	X
SMAJ60A	SMAJ60CA	RK	ZK	60.0	66.70	73.70	1	96.8	4.1	1	X
SMAJ64A	SMAJ64CA	RM	ZM	64.0	71.10	78.60	1	103.0	3.9	1	X
SMAJ70A	SMAJ70CA	RP	ZP	70.0	77.80	86.00	1	113.0	3.5	1	X
SMAJ75A	SMAJ75CA	RR	ZR	75.0	83.30	92.10	1	121.0	3.3	1	X
SMAJ78A	SMAJ78CA	RT	ZT	78.0	86.70	95.80	1	126.0	3.2	1	X
SMAJ85A	SMAJ85CA	RV	ZV	85.0	94.40	104.00	1	137.0	2.9	1	X
SMAJ90A	SMAJ90CA	RX	ZX	90.0	100.00	111.00	1	146.0	2.7	1	X
SMAJ100A	SMAJ100CA	RZ	ZZ	100.0	111.00	123.00	1	162.0	2.5	1	X
SMAJ110A	SMAJ110CA	SE	VE	110.0	122.00	135.00	1	177.0	2.3	1	X
SMAJ120A	SMAJ120CA	SG	VG	120.0	133.00	147.00	1	193.0	2.1	1	X
SMAJ130A	SMAJ130CA	SK	VK	130.0	144.00	159.00	1	209.0	1.9	1	X
SMAJ150A	SMAJ150CA	SM	VM	150.0	167.00	185.00	1	243.0	1.6	1	X
SMAJ160A	SMAJ160CA	SP	VP	160.0	178.00	197.00	1	259.0	1.5	1	X
SMAJ170A	SMAJ170CA	SR	VR	170.0	189.00	209.00	1	275.0	1.5	1	X
SMAJ180A	SMAJ180CA	ST	VT	180.0	201.00	222.00	1	292.0	1.4	1	X
SMAJ200A	SMAJ200CA	SV	VV	200.0	224.00	247.00	1	324.0	1.2	1	X
SMAJ220A	SMAJ220CA	SX	VX	220.0	246.00	272.00	1	356.0	1.1	1	X
SMAJ250A	SMAJ250CA	SZ	VZ	250.0	279.00	309.00	1	405.0	1.0	1	X
SMAJ300A	SMAJ300CA	TE	UE	300.0	335.00	371.00	1	486.0	0.8	1	X
SMAJ350A	SMAJ350CA	TG	UG	350.0	391.00	432.00	1	567.0	0.7	1	X
SMAJ400A	SMAJ400CA	TK	UK	400.0	447.00	494.00	1	648.0	0.6	1	X
SMAJ440A	SMAJ440CA	TM	UM	440.0	492.00	543.00	1	713.0	0.6	1	X

For bidirectional type having V_{RWM} of 10 volts and less, the I_R limit is double.

For parts without A (V_{BR} is $\pm 10\%$ and V_C is 5% higher than with A parts).

Ratings and Characteristic Curves ($T_A=25^\circ\text{C}$ unless otherwise noted)

Figure 1 - Peak Pulse Power Rating Curve

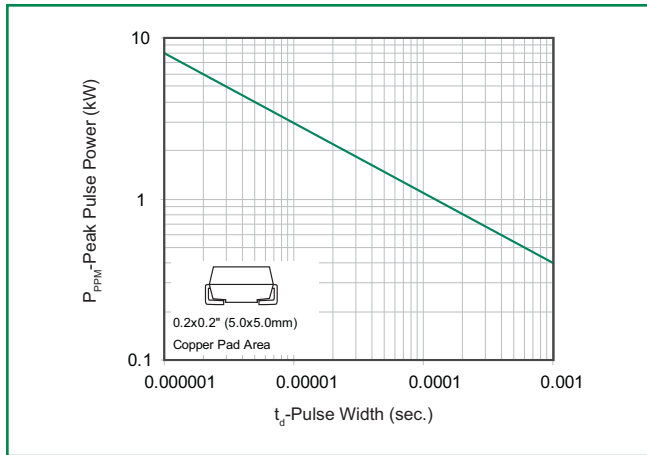

Figure 2 - Pulse Derating Curve

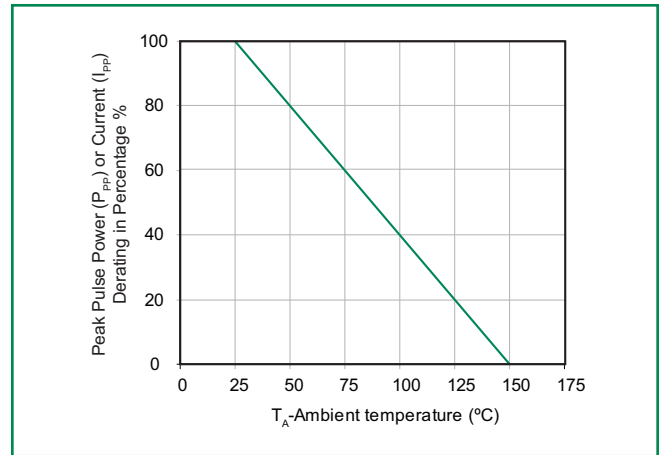

Figure 3 - Pulse Waveform

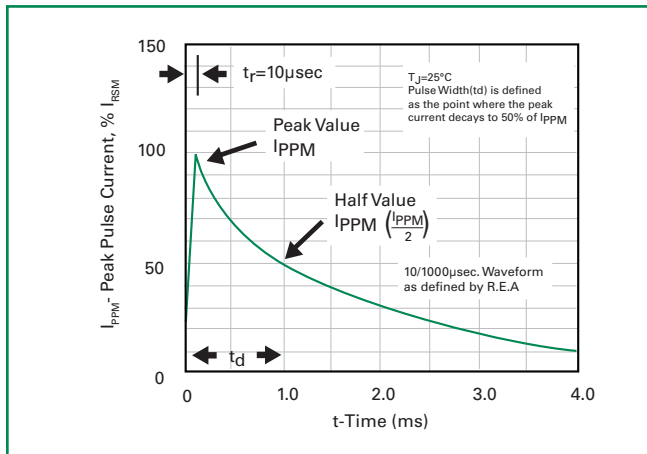

Figure 4 - Typical Junction Capacitance

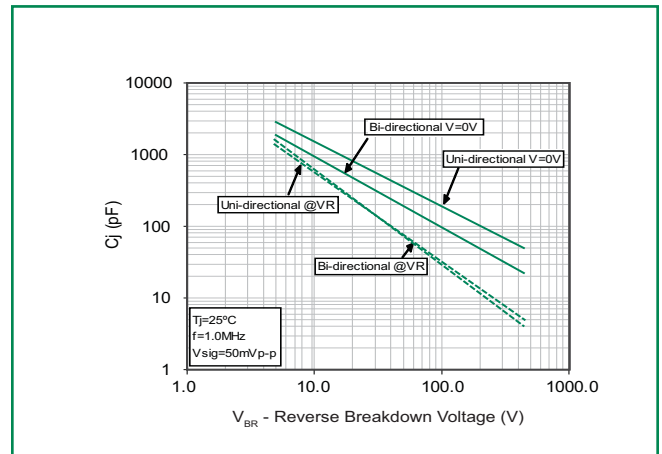

Figure 5 - Steady State Power Dissipation Derating Curve

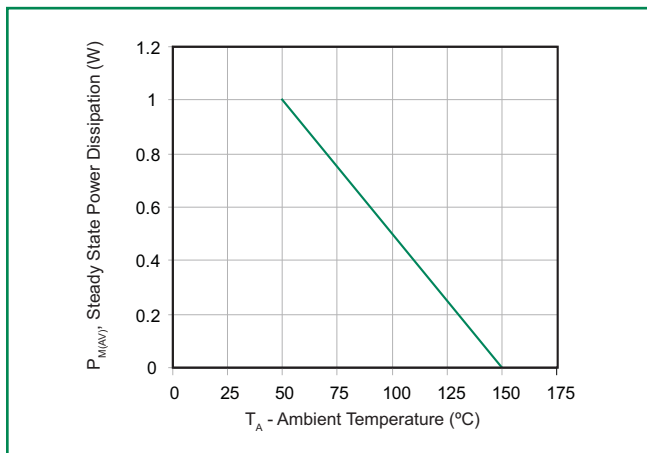
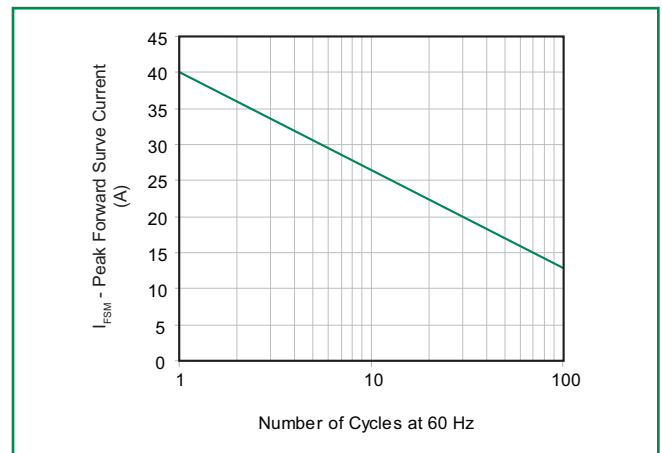
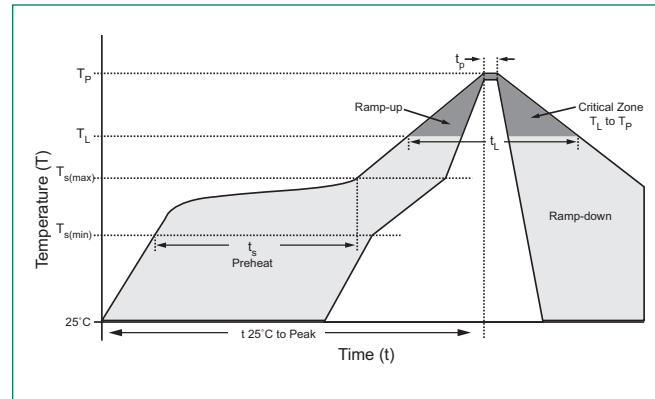

Figure 6 - Maximum Non-Repetitive Forward Surge Current Uni-Directional Only



Soldering Parameters

Reflow Condition		Lead-free assembly
Pre Heat	- Temperature Min ($T_{s(min)}$)	150°C
	- Temperature Max ($T_{s(max)}$)	200°C
	- Time (min to max) (t_s)	60 – 180 secs
Average ramp up rate (Liquidus Temp (T_L) to peak)		3°C/second max
$T_{s(max)}$ to T_L - Ramp-up Rate		3°C/second max
Reflow	- Temperature (T_L) (Liquidus)	217°C
	- Time (min to max) (t_s)	60 – 150 seconds
Peak Temperature (T_p)		260 ^{+0/-5} °C
Time within 5°C of actual peak Temperature (t_p)		20 – 40 seconds
Ramp-down Rate		6°C/second max
Time 25°C to peak Temperature (T_p)		8 minutes Max.
Do not exceed		280°C



Physical Specifications

Weight	0.002 ounce, 0.061 gram
Case	JEDEC DO-214AC Molded Plastic over glass passivated junction
Polarity	Color band denotes cathode except Bipolar
Terminal	Matte Tin-plated leads, Solderable per JESD22-B102D

Environmental Specifications

Temperature Cycle	MIL-STD-883F, Method 1010.8
Pressure Cooker	JESD 22-A102C
High Temp. Storage	JESD 22-A103C
HTRB	JESD , 22-108C
Thermal Shock	JESD 22 A 106

Dimensions

DO-214AC (SMA)

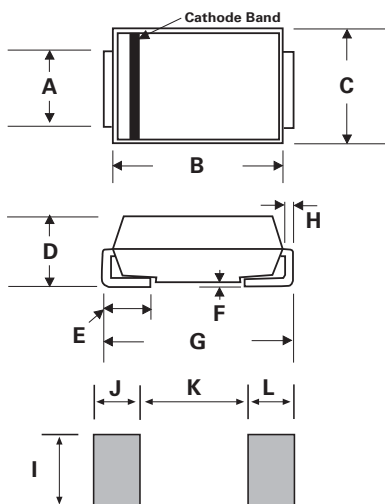

Dimensions	Inches		Millimeters	
	Min	Max	Min	Max
A	0.049	0.065	1.250	1.650
B	0.157	0.177	3.990	4.500
C	0.100	0.110	2.540	2.790
D	0.078	0.090	1.980	2.290
E	0.030	0.060	0.780	1.520
F	-	0.008	-	0.203
G	0.194	0.208	4.930	5.280
H	0.006	0.012	0.152	0.305
I	0.070	-	1.800	-
J	0.082	-	2.100	-
K	-	0.090	-	2.300
L	0.082	-	2.100	-

Part Numbering System

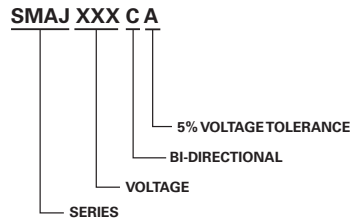

Part Marking System

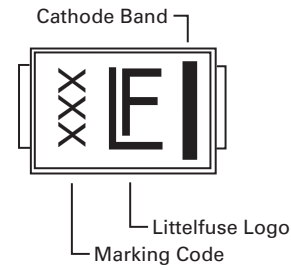

Packaging

Part number	Component Package	Quantity	Packaging Option	Packaging Specification
SMAJxxxXX	DO-214AC	5000	Tape & Reel – 12mm/13" tape	EIA RS-481

RoHS P4SMA Series

Agency Approvals

AGENCY	AGENCY FILE NUMBER
	E230531

Maximum Ratings and Thermal Characteristics
 (T_A=25°C unless otherwise noted)

Parameter	Symbol	Value	Unit
Peak Pulse Power Dissipation at T _A =25°C by 10x1000µs waveform (Fig.1)(Note 1), (Note 2)	P _{PPM}	400	W
Power Dissipation on infinite heat sink at T _A =50°C	P _{M(AV)}	3.3	W
Peak Forward Surge Current, 8.3ms Single Half Sine Wave (Note 3)	I _{FSM}	40	A
Maximum Instantaneous Forward Voltage at 25A for Unidirectional only (Note 4)	V _F	3.5V/6.5	V
Operating Junction and Storage Temperature Range	T _J , T _{STG}	-65 to 150	°C
Typical Thermal Resistance Junction to Lead	R _{θJL}	30	°C/W
Typical Thermal Resistance Junction to Ambient	R _{θJA}	120	°C/W

Notes:

1. Non-repetitive current pulse, per Fig. 3 and derated above T_A = 25°C per Fig. 2.
2. Mounted on 0.2x0.2" (5.0 x 5.0mm) copper pad to each terminal.
3. Measured on 8.3ms single half sine wave or equivalent square wave for unidirectional device only, duty cycle=4 per minute maximum.
4. V_F<3.5V for V_{BR} ≤ 200V and V_F<6.5V for V_{BR} ≥ 201V.

Description

The P4SMA series is designed specifically to protect sensitive electronic equipment from voltage transients induced by lightning and other transient voltage events.

Features

- RoHS compliant
- For surface mounted applications to optimize board space
- Low profile package
- Built-in strain relief
- Typical maximum temperature coefficient V_{BR} = 0.1% × V_{BR} @25°C
- Glass passivated chip junction
- 400W peak pulse power capability at 10x1000µs waveform, repetition rate (duty cycles):0.01%
- Fast response time: typically less than 1.0ps from 0V to BV min
- Excellent clamping capability
- Low incremental surge resistance
- Typical I_R less than 1µA above 12V
- High Temperature soldering guaranteed: 260°C/40 seconds at terminals
- Plastic package has Underwriters Laboratory Flammability 94V-O
- Matte Tin Lead-free Plated

Applications

TVS devices are ideal for the protection of I/O Interfaces, V_{CC} bus and other vulnerable circuits used in Telecom, Computer, Industrial and Consumer electronic applications.

Electrical Characteristics

Part Number (Uni)	Part Number (Bi)	Marking		Reverse Stand off Voltage V_R (Volts)	Breakdown Voltage V_{BR} (Volts) @ I_T		Test Current I_T (mA)	Maximum Clamping Voltage V_C @ I_{PP} (V)	Maximum Peak Pulse Current I_{PP} (A)	Maximum Reverse Leakage I_R @ V_R (μ A)	Agency Approval 
		UNI	BI		MIN	MAX					
P4SMA6.8A	P4SMA6.8CA	6V8A	6V8C	5.80	6.45	7.14	10	10.5	39.0	1000	X
P4SMA7.5A	P4SMA7.5CA	7V5A	7V5C	6.40	7.13	7.88	10	11.3	36.3	500	X
P4SMA8.2A	P4SMA8.2CA	8V2A	8V2C	7.02	7.79	8.61	10	12.1	33.9	200	X
P4SMA9.1A	P4SMA9.1CA	9V1A	9V1C	7.78	8.65	9.55	1	13.4	30.6	50	X
P4SMA10A	P4SMA10CA	10A	10C	8.55	9.50	10.50	1	14.5	28.3	10	X
P4SMA11A	P4SMA11CA	11A	11C	9.40	10.50	11.60	1	15.6	26.3	5	X
P4SMA12A	P4SMA12CA	12A	12C	10.20	11.40	12.60	1	16.7	24.6	5	X
P4SMA13A	P4SMA13CA	13A	13C	11.10	12.40	13.70	1	18.2	22.5	1	X
P4SMA15A	P4SMA15CA	15A	15C	12.80	14.30	15.80	1	21.2	19.3	1	X
P4SMA16A	P4SMA16CA	16A	16C	13.60	15.20	16.80	1	22.5	18.2	1	X
P4SMA18A	P4SMA18CA	18A	18C	15.30	17.10	18.90	1	25.5	16.1	1	X
P4SMA20A	P4SMA20CA	20A	20C	17.10	19.00	21.00	1	27.7	14.8	1	X
P4SMA22A	P4SMA22CA	22A	22C	18.80	20.90	23.10	1	30.6	13.4	1	X
P4SMA24A	P4SMA24CA	24A	24C	20.50	22.80	25.20	1	33.2	12.3	1	X
P4SMA27A	P4SMA27CA	27A	27C	23.10	25.70	28.40	1	37.5	10.9	1	X
P4SMA30A	P4SMA30CA	30A	30C	25.60	28.50	31.50	1	41.4	9.9	1	X
P4SMA33A	P4SMA33CA	33A	33C	28.20	31.40	34.70	1	45.7	9.0	1	X
P4SMA36A	P4SMA36CA	36A	36C	30.80	34.20	37.80	1	49.9	8.2	1	X
P4SMA39A	P4SMA39CA	39A	39C	33.30	37.10	41.00	1	53.9	7.6	1	X
P4SMA43A	P4SMA43CA	43A	43C	36.80	40.90	45.20	1	59.3	6.9	1	X
P4SMA47A	P4SMA47CA	47A	47C	40.20	44.70	49.40	1	64.8	6.3	1	X
P4SMA51A	P4SMA51CA	51A	51C	43.60	48.50	53.60	1	70.1	5.8	1	X
P4SMA56A	P4SMA56CA	56A	56C	47.80	53.20	58.80	1	77.0	5.3	1	X
P4SMA62A	P4SMA62CA	62A	62C	53.00	58.90	65.10	1	85.0	4.8	1	X
P4SMA68A	P4SMA68CA	68A	68C	58.10	64.60	71.40	1	92.0	4.5	1	X
P4SMA75A	P4SMA75CA	75A	75C	64.10	71.30	78.80	1	103.0	4.0	1	X
P4SMA82A	P4SMA82CA	82A	82C	70.10	77.90	86.10	1	113.0	3.6	1	X
P4SMA91A	P4SMA91CA	91A	91C	77.80	86.50	95.50	1	125.0	3.3	1	X
P4SMA100A	P4SMA100CA	100A	100C	85.50	95.00	105.00	1	137.0	3.0	1	X
P4SMA110A	P4SMA110CA	110A	110C	94.00	105.00	116.00	1	152.0	2.7	1	X
P4SMA120A	P4SMA120CA	120A	120C	102.00	114.00	126.00	1	165.0	2.5	1	X
P4SMA130A	P4SMA130CA	130A	130C	111.00	124.00	137.00	1	179.0	2.3	1	X
P4SMA150A	P4SMA150CA	150A	150C	128.00	143.00	158.00	1	207.0	2.0	1	X
P4SMA160A	P4SMA160CA	160A	160C	136.00	152.00	168.00	1	219.0	1.9	1	X
P4SMA170A	P4SMA170CA	170A	170C	145.00	162.00	179.00	1	234.0	1.8	1	X
P4SMA180A	P4SMA180CA	180A	180C	154.00	171.00	189.00	1	246.0	1.7	1	X
P4SMA200A	P4SMA200CA	200A	200C	171.00	190.00	210.00	1	274.0	1.5	1	X
P4SMA220A	P4SMA220CA	220A	220C	185.00	209.00	231.00	1	328.0	1.3	1	X
P4SMA250A	P4SMA250CA	250A	250C	214.00	237.00	263.00	1	344.0	1.2	1	X
P4SMA300A	P4SMA300CA	300A	300C	256.00	285.00	315.00	1	414.0	1.0	1	X
P4SMA350A	P4SMA350CA	350A	350C	300.00	332.00	368.00	1	482.0	0.9	1	X
P4SMA400A	P4SMA400CA	400A	400C	342.00	380.00	420.00	1	548.0	0.8	1	X
P4SMA440A	P4SMA440CA	440A	440C	376.00	418.00	462.00	1	602.0	0.7	1	X
P4SMA480A	P4SMA480CA	480A	480C	408.00	456.00	504.00	1	658.0	0.6	1	
P4SMA510A	P4SMA510CA	510A	510C	434.00	485.00	535.00	1	698.0	0.6	1	
P4SMA530A	P4SMA530CA	530A	530C	477.00	503.50	556.50	1	725.0	0.6	1	
P4SMA540A	P4SMA540CA	540A	540C	486.00	513.00	567.00	1	740.0	0.5	1	
P4SMA550A	P4SMA550CA	550A	550C	495.00	522.50	577.50	1	760.0	0.5	1	

The available parts are "A" type only, the parts without A (V_{BR} is $\pm 10\%$) is not available.

For bidirectional type having V_R of 10 volts and less, the I_R limit is double.

Ratings and Characteristic Curves ($T_A=25^\circ\text{C}$ unless otherwise noted)

Figure 1 - Peak Pulse Power Rating

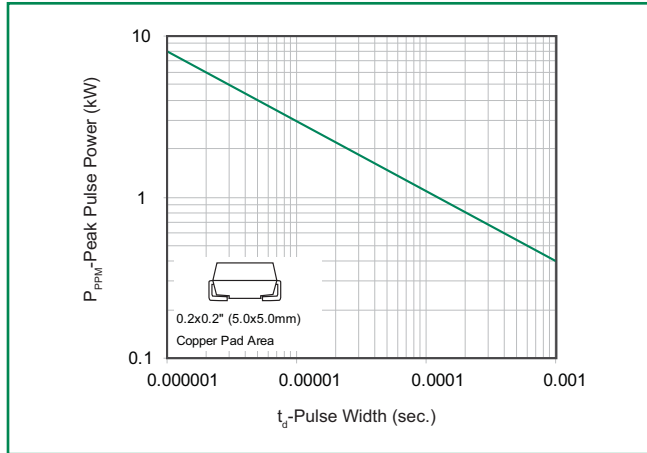

Figure 2 - Pulse Derating Curve

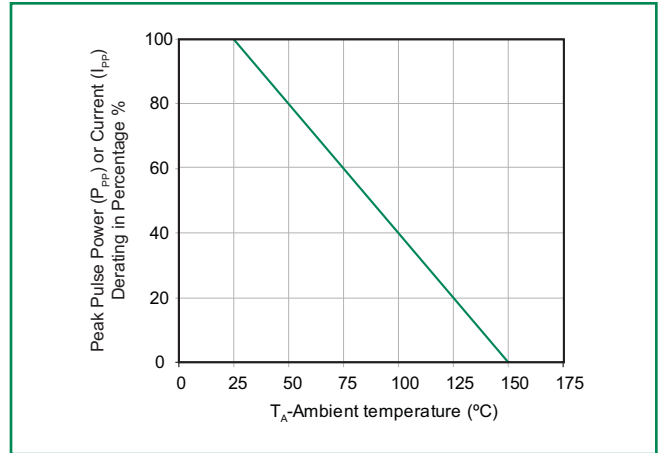

Figure 3 - Pulse Waveform

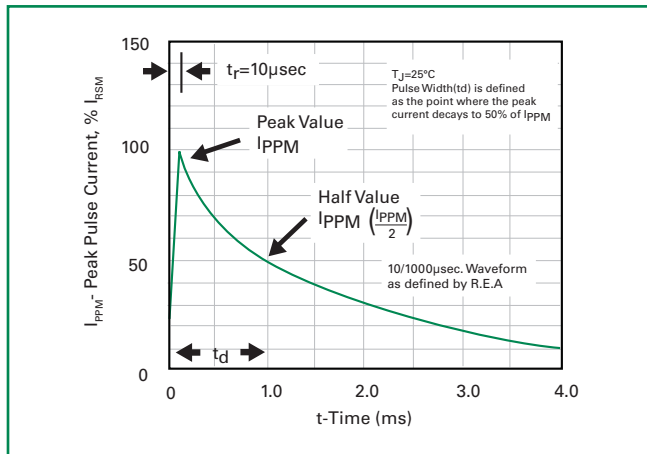

Figure 4 - Typical Junction Capacitance

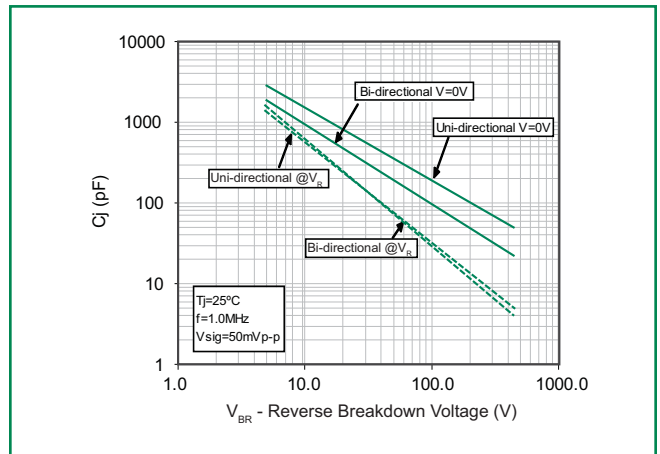

Figure 5 - Steady State Power Dissipation Derating Curve

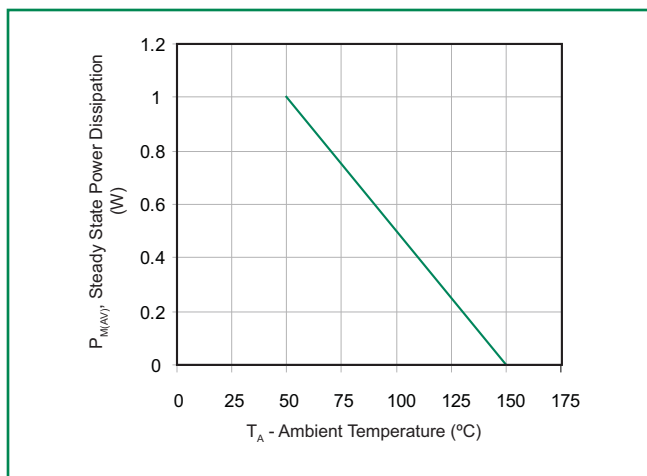
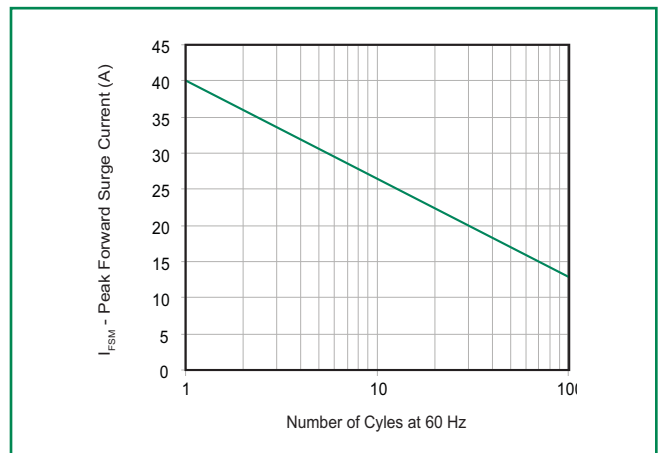
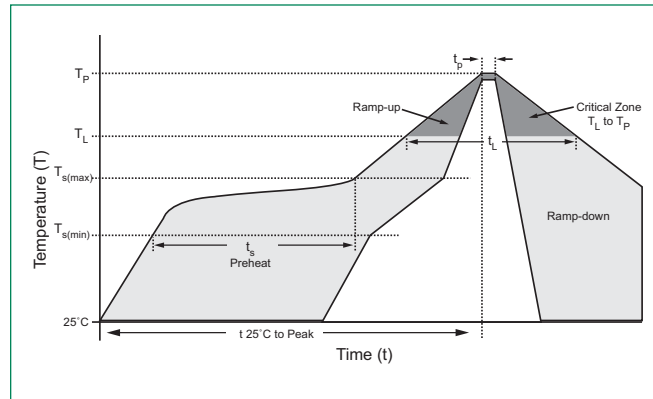

Figure 6 - Maximum Non-Repetitive Forward Surge Current Uni-Directional Only



Soldering Parameters

Reflow Condition		Lead-free assembly
Pre Heat	- Temperature Min ($T_{s(min)}$)	150°C
	- Temperature Max ($T_{s(max)}$)	200°C
	- Time (min to max) (t_s)	60 – 180 secs
Average ramp up rate (Liquidus Temp (T_L) to peak)		3°C/second max
$T_{s(max)}$ to T_L - Ramp-up Rate		3°C/second max
Reflow	- Temperature (T_L) (Liquidus)	217°C
	- Time (min to max) (t_s)	60 – 150 seconds
Peak Temperature (T_p)		260 ^{+0/-5} °C
Time within 5°C of actual peak Temperature (t_p)		20 – 40 seconds
Ramp-down Rate		6°C/second max
Time 25°C to peak Temperature (T_p)		8 minutes Max.
Do not exceed		280°C



Physical Specifications

Weight	0.002 ounce, 0.061 gram
Case	JEDEC DO-214AC. Molded plastic body over glass passivated junction
Polarity	Color band denotes positive end (cathode) except bidirectional
Terminal	Matte Tin-plated leads, Solderable per JESD22-B102D

Environmental Specifications

Temperature Cycle	JESD22-A104
Pressure Cooker	JESD 22-A102
High Temp. Storage	JESD22-A103
HTRB	JESD22-A108
Thermal Shock	JESD22-A106

Dimensions

DO-214AC (SMA)

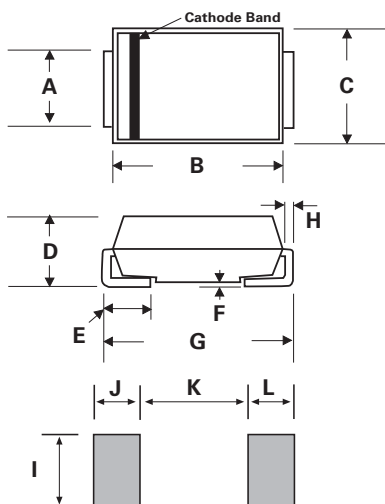

Dimensions	Inches		Millimeters	
	Min	Max	Min	Max
A	0.049	0.065	1.250	1.650
B	0.157	0.177	3.990	4.500
C	0.100	0.110	2.540	2.790
D	0.078	0.090	1.980	2.290
E	0.030	0.060	0.780	1.520
F	-	0.008	-	0.203
G	0.194	0.208	4.930	5.280
H	0.006	0.012	0.152	0.305
I	0.070	-	1.800	-
J	0.082	-	2.100	-
K	-	0.090	-	2.300
L	0.082	-	2.100	-

Part Numbering System

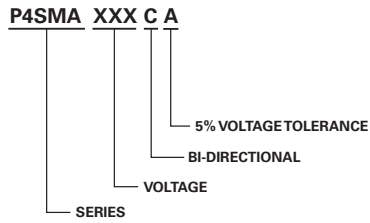

Part Marking System

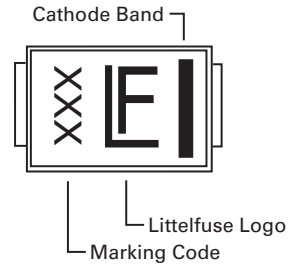

Packaging

Part number	Component Package	Quantity	Packaging Option	Packaging Specification
P4SMAxxxXX	DO-214AC	5000	Tape & Reel – 12mm/13" tape	EIA STD RS-481

RoHS SACB Series

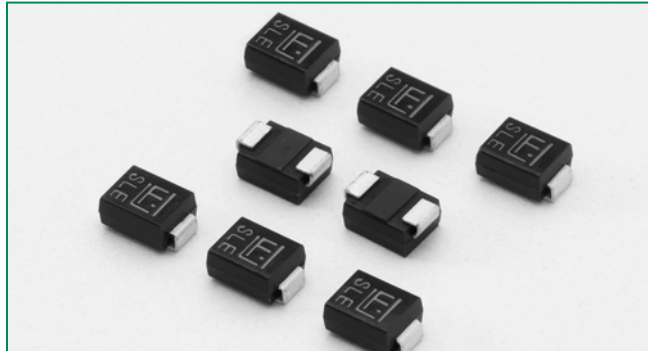

Agency Approvals

AGENCY	AGENCY FILE NUMBER
	E230531

**Maximum Ratings and Thermal Characteristics
(T_A=25°C unless otherwise noted)**

Parameter	Symbol	Value	Unit
Peak pulse power dissipation at T _a =25°C by 10×1000µs waveform (fig.1)(Note 1)	P _{PPM}	500	W
Power dissipation on infinite heat sink at T _j =50°C	P _{MAV}	3.0	W
Peak Pulse Power Dissipation at T _a =25°C by 10×1000µs waveform (Fig. 3) (Note 1)	I _{PPM}	See Table 1	Amps
Operating Junction and Storage Temperature Range	T _J , T _{STG}	-65 to 150	°C
Typical Thermal Resistance Junction to Lead	R _{θJL}	30	°C/W
Typical Thermal Resistance Junction to Ambient	R _{θJA}	120	°C/W

Note:

1. Non-repetitive current pulse, per Fig. 3 and derated above T_A = 25°C per Fig. 2.

Description

SACB series is designed specifically to protect sensitive electronic equipment from voltage transients induced by lightning and other transient voltage events.

Features

- RoHS compliant
- For surface mounted applications in order to optimize board space
- Low profile package
- Built-in strain relief
- Typical maximum temperature coefficient $\Delta V_{BR} = 0.1\% \times V_{BR} @ 25^\circ\text{C}$
- Glass passivated chip junction
- 500W peak pulse power capability at 10×1000µs waveform, repetition rate (duty cycles):0.01%
- Fast response time: typically less than 1.0ps from 0V to BV min
- Excellent clamping capability
- Low incremental surge resistance
- High Temperature soldering guaranteed: 260°C/40 seconds at terminals
- Plastic package has Underwriters Laboratory Flammability 94V-0
- Matte Tin Lead-free Plated

Applications

TVS devices are ideal for the protection of I/O Interfaces, V_{CC} bus and other vulnerable circuits used in Telecom, Computer, Industrial and Consumer electronic applications.

SACB Series

Electrical Characteristics

Part Number	Marking Code	Stand-Off Voltage (Note1) V_R (V)	Minimum Breakdown Voltage at $I_T=1.0\text{MA}$ $V_{BR}(V)$	Maximum Reverse Leakage at V_R I_R (μA)	Maximum Clamping Voltage at $I_{PP}=5.0\text{A}$ $V_C(V)$	Maximum Peak Pulse Current per (Fig.3) $I_{PP}(A)$	Maximum Junction Capacitance at 0 Volts (pF)	Working Inverse Blocking Voltage $V_{WIB}(V)$	Inverse Blocking Leakage Current at V_{WIB} @ I_{IB} (mA)	Peak Inverse Blocking Voltage V_{PIB} (V)	UL Recognition
SACB5.0	SKE	5.0	7.60	300	10.0	44.0	45	75	1.0	100	X
SACB6.0	SKG	6.0	7.90	300	11.2	41.0	45	75	1.0	100	X
SACB7.0	SKM	7.0	8.33	300	12.6	38.0	45	75	1.0	100	X
SACB8.0	SKR	8.0	8.89	100	13.4	36.0	45	75	1.0	100	X
SACB8.5	SKT	8.5	9.44	50	14.0	34.0	45	75	1.0	100	X
SACB10	SKX	10.0	11.10	5	16.3	29.0	45	75	1.0	100	X
SACB12	SLE	12.0	13.30	5	19.0	25.0	45	75	1.0	100	X
SACB15	SLM	15.0	16.70	5	23.6	20.0	45	75	1.0	100	X
SACB18	SLT	18.0	20.00	5	28.8	15.0	45	75	1.0	100	X
SACB22	SLX	22.0	24.40	5	35.4	14.0	45	75	1.0	100	X
SACB26	SME	26.0	28.90	5	42.3	11.1	45	75	1.0	100	X
SACB30	SMK	30.0	33.30	5	48.6	10.0	45	75	1.0	100	X
SACB36	SMP	36.0	40.00	5	60.0	8.6	45	75	1.0	100	X
SACB45	SMV	45.0	50.00	5	77.0	6.8	45	150	1.0	200	X
SACB50	SMZ	50.0	55.50	5	88.0	5.8	45	150	1.0	200	X

Ratings and Characteristic Curves ($T_A=25^\circ\text{C}$ unless otherwise noted)

Figure 1 - Peak Pulse Power Rating Curve

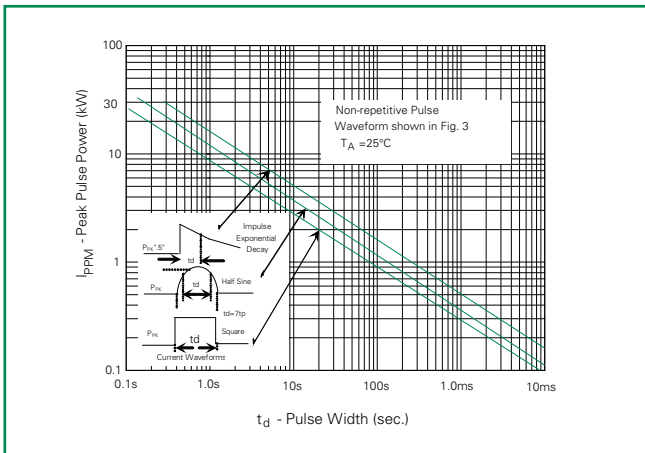

Figure 2 - Pulse Derating Curve

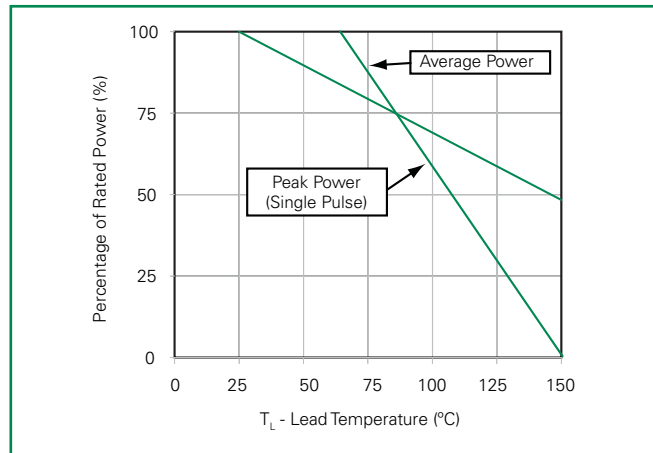

Figure 3 - Pulse Waveform

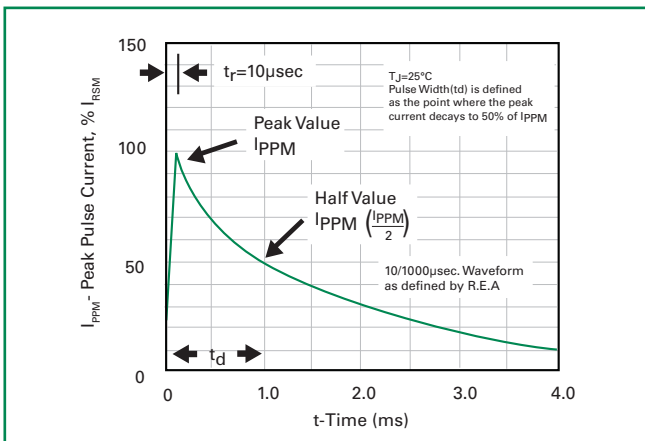
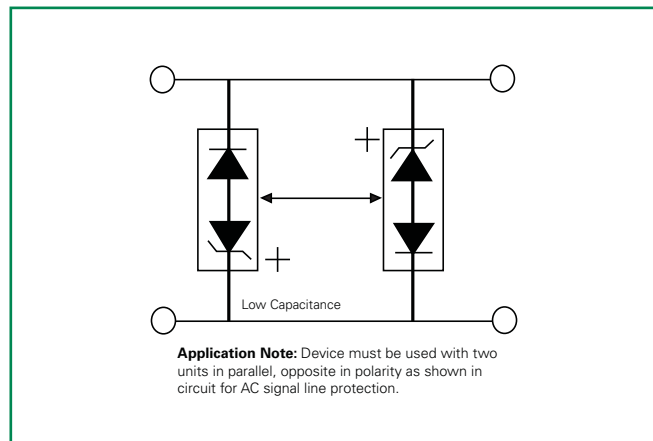
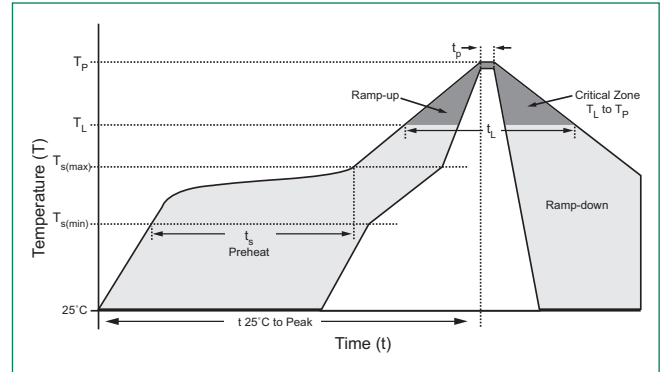

Figure 4 - AC Line Protection Application



Soldering Parameters

Reflow Condition		Lead-free assembly
Pre Heat	- Temperature Min ($T_{s(min)}$)	150°C
	- Temperature Max ($T_{s(max)}$)	200°C
	- Time (min to max) (t_s)	60 – 180 secs
Average ramp up rate (Liquidus Temp (T_L) to peak)		3°C/second max
$T_{s(max)}$ to T_L - Ramp-up Rate		3°C/second max
Reflow	- Temperature (T_L) (Liquidus)	217°C
	- Time (min to max) (t_s)	60 – 150 seconds
Peak Temperature (T_p)		260 ^{+0/-5} °C
Time within 5°C of actual peak Temperature (t_p)		20 – 40 seconds
Ramp-down Rate		6°C/second max
Time 25°C to peak Temperature (T_p)		8 minutes Max.
Do not exceed		280°C



Flow/Wave Soldering (Solder Dipping)

Peak Temperature :	265°C
Dipping Time :	10 seconds
Soldering :	1 time

Physical Specifications

Weight	0.003oz., 0.093g
Case	JEDEC DO-214AA molded plastic body over glass passivated junction.
Polarity	Color band denotes cathode except Bidirectional
Terminal	Matte Tin-plated leads. Solderable per JESD22-B102D.

Environmental Specifications

Temperature Cycle	JESD22-A104
Pressure Cooker	JESD 22-A102
High Temp. Storage	JESD22-A103
HTRB	JESD22-A108
Thermal Shock	JESD22-A106

Dimensions

DO-214AA (SMB J-Bend)

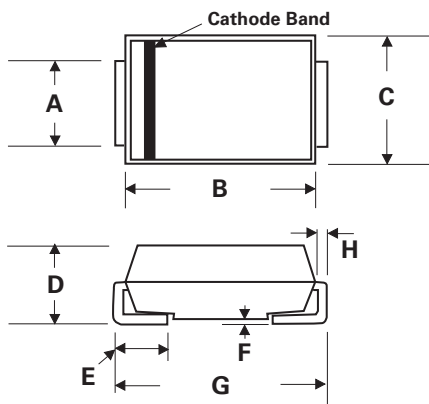

Dimensions	Inches		Millimeters	
	Min	Max	Min	Max
A	0.077	0.086	1.950	2.200
B	0.160	0.180	4.060	4.570
C	0.130	0.155	3.300	3.940
D	0.084	0.096	2.130	2.440
E	0.030	0.060	0.760	1.520
F	-	0.008	-	0.203
G	0.205	0.220	5.210	5.590
H	0.006	0.012	0.152	0.305

Part Numbering System

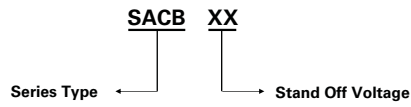

Part Marking System

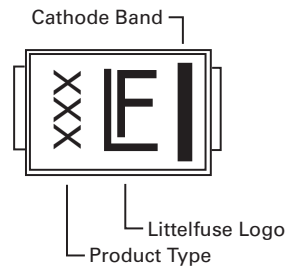

Packaging

Part number	Component Package	Quantity	Packaging Option	Packaging Specification
SACBXX	DO-214AA	3000	Tape & Reel – 12mm/13" tape	EIA STD RS-481

Schematic

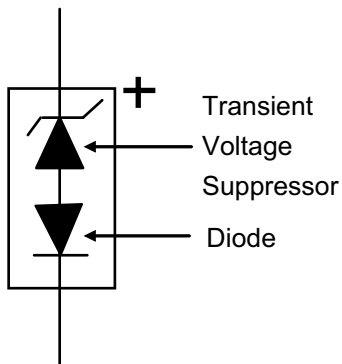

RoHS SMBJ Series



Agency Approvals

AGENCY	AGENCY FILE NUMBER
	E128662/E230531

Maximum Ratings and Thermal Characteristics (T_A=25°C unless otherwise noted)

Parameter	Symbol	Value	Unit
Peak Pulse Power Dissipation at T _A =25°C by 10x1000µs waveform (Fig.1)(Note 1), (Note 2)	P _{PPM}	600	W
Power Dissipation on infinite heat sink at T _A =50°C	P _{M(AV)}	5.0	W
Peak Forward Surge Current, 8.3ms Single Half Sine Wave (Note 3)	I _{FSM}	100	A
Maximum Instantaneous Forward Voltage at 50A for Unidirectional only (Note 4)	V _F	3.5V/5.0	V
Operating Junction and Storage Temperature Range	T _J , T _{STG}	-65 to 150	°C
Typical Thermal Resistance Junction to Lead	R _{θJL}	20	°C/W
Typical Thermal Resistance Junction to Ambient	R _{θJA}	100	°C/W

Notes:

1. Non-repetitive current pulse, per Fig. 3 and derated above T_A = 25°C per Fig. 2.
2. Mounted on copper pad area of 0.2x0.2" (5.0 x 5.0mm) to each terminal.
3. Measured on 8.3ms single half sine wave or equivalent square wave for unidirectional device only, duty cycle=4 per minute maximum.
4. V_F<3.5V for V_{BR} ≤ 200V and V_F<5.0V for V_{BR} ≥ 201V.

Description

The SMBJ series is designed specifically to protect sensitive electronic equipment from voltage transients induced by lightning and other transient voltage events.

Features

- RoHS compliant
- For surface mounted applications to optimize board space
- Low profile package
- Built-in strain relief
- Typical maximum temperature coefficient $\Delta V_{BR} = 0.1\% \times V_{BR} @ 25^\circ\text{C}$
- Glass passivated chip junction
- 600W peak pulse power capability at 10x1000µs waveform, repetition rate (duty cycles):0.01%
- Fast response time: typically less than 1.0ps from 0V to BV min
- Excellent clamping capability
- Low incremental surge resistance
- Typical I_R less than 1µA above 12V
- High Temperature soldering guaranteed: 260°C/40 seconds at terminals
- Plastic package has Underwriters Laboratory Flammability 94V-0
- Matte Tin Lead-free Plated

Applications

TVS devices are ideal for the protection of I/O Interfaces, V_{CC} bus and other vulnerable circuits used in Telecom, Computer, Industrial and Consumer electronic applications.

Electrical Characteristics

Part Number (Uni)	Part Number (Bi)	Marking		Reverse Stand off Voltage V_R (Volts)	Breakdown Voltage V_{BR} (Volts) @ I_T		Test Current I_T (mA)	Maximum Clamping Voltage V_C @ I_{PP} (V)	Maximum Peak Pulse Current I_{PP} (A)	Maximum Reverse Leakage I_R @ V_R (μ A)	Agency Approval 
		UNI	BI		MIN	MAX					
SMBJ5.0A	SMBJ5.0CA	KE	AE	5.0	6.40	7.00	10	9.2	65.3	800	X
SMBJ6.0A	SMBJ6.0CA	KG	AG	6.0	6.67	7.37	10	10.3	58.3	800	X
SMBJ6.5A	SMBJ6.5CA	KK	AK	6.5	7.22	7.98	10	11.2	53.6	500	X
SMBJ7.0A	SMBJ7.0CA	KM	AM	7.0	7.78	8.60	10	12.0	50.0	200	X
SMBJ7.5A	SMBJ7.5CA	KP	AP	7.5	8.33	9.21	1	12.9	46.6	100	X
SMBJ8.0A	SMBJ8.0CA	KR	AR	8.0	8.89	9.83	1	13.6	44.2	50	X
SMBJ8.5A	SMBJ8.5CA	KT	AT	8.5	9.44	10.40	1	14.4	41.7	20	X
SMBJ9.0A	SMBJ9.0CA	KV	AV	9.0	10.00	11.10	1	15.4	39.0	10	X
SMBJ10A	SMBJ10CA	KX	AX	10.0	11.10	12.30	1	17.0	35.3	5	X
SMBJ11A	SMBJ11CA	KZ	AZ	11.0	12.20	13.50	1	18.2	33.0	1	X
SMBJ12A	SMBJ12CA	LE	BE	12.0	13.30	14.70	1	19.9	30.2	1	X
SMBJ13A	SMBJ13CA	LG	BG	13.0	14.40	15.90	1	21.5	28.0	1	X
SMBJ14A	SMBJ14CA	LK	BK	14.0	15.60	17.20	1	23.2	25.9	1	X
SMBJ15A	SMBJ15CA	LM	BM	15.0	16.70	18.50	1	24.4	24.6	1	X
SMBJ16A	SMBJ16CA	LP	BP	16.0	17.80	19.70	1	26.0	23.1	1	X
SMBJ17A	SMBJ17CA	LR	BR	17.0	18.90	20.90	1	27.6	21.8	1	X
SMBJ18A	SMBJ18CA	LT	BT	18.0	20.00	22.10	1	29.2	20.6	1	X
SMBJ20A	SMBJ20CA	LV	BV	20.0	22.20	24.50	1	32.4	18.6	1	X
SMBJ22A	SMBJ22CA	LX	BX	22.0	24.40	26.90	1	35.5	16.9	1	X
SMBJ24A	SMBJ24CA	LZ	BZ	24.0	26.70	29.50	1	38.9	15.5	1	X
SMBJ26A	SMBJ26CA	ME	CE	26.0	28.90	31.90	1	42.1	14.3	1	X
SMBJ28A	SMBJ28CA	MG	CG	28.0	31.10	34.40	1	45.4	13.3	1	X
SMBJ30A	SMBJ30CA	MK	CK	30.0	33.30	36.80	1	48.4	12.4	1	X
SMBJ33A	SMBJ33CA	MM	CM	33.0	36.70	40.60	1	53.3	11.3	1	X
SMBJ36A	SMBJ36CA	MP	CP	36.0	40.00	44.20	1	58.1	10.4	1	X
SMBJ40A	SMBJ40CA	MR	CR	40.0	44.40	49.10	1	64.5	9.3	1	X
SMBJ43A	SMBJ43CA	MT	CT	43.0	47.80	52.80	1	69.4	8.7	1	X
SMBJ45A	SMBJ45CA	MV	CV	45.0	50.00	55.30	1	72.7	8.3	1	X
SMBJ48A	SMBJ48CA	MX	CX	48.0	53.30	58.90	1	77.4	7.8	1	X
SMBJ51A	SMBJ51CA	MZ	CZ	51.0	56.70	62.70	1	82.4	7.3	1	X
SMBJ54A	SMBJ54CA	NE	DE	54.0	60.00	66.30	1	87.1	6.9	1	X
SMBJ58A	SMBJ58CA	NG	DG	58.0	64.40	71.20	1	93.6	6.5	1	X
SMBJ60A	SMBJ60CA	NK	DK	60.0	66.70	73.70	1	96.8	6.2	1	X
SMBJ64A	SMBJ64CA	NM	DM	64.0	71.10	78.60	1	103.0	5.9	1	X
SMBJ70A	SMBJ70CA	NP	DP	70.0	77.80	86.00	1	113.0	5.3	1	X
SMBJ75A	SMBJ75CA	NR	DR	75.0	83.30	92.10	1	121.0	5.0	1	X
SMBJ78A	SMBJ78CA	NT	DT	78.0	86.70	95.80	1	126.0	4.8	1	X
SMBJ85A	SMBJ85CA	NV	DV	85.0	94.40	104.00	1	137.0	4.4	1	X
SMBJ90A	SMBJ90CA	NX	DX	90.0	100.00	111.00	1	146.0	4.1	1	X
SMBJ100A	SMBJ100CA	NZ	DZ	100.0	111.00	123.00	1	162.0	3.7	1	X
SMBJ110A	SMBJ110CA	PE	EE	110.0	122.00	135.00	1	177.0	3.4	1	X
SMBJ120A	SMBJ120CA	PG	EG	120.0	133.00	147.00	1	193.0	3.1	1	X
SMBJ130A	SMBJ130CA	PK	EK	130.0	144.00	159.00	1	209.0	2.9	1	X
SMBJ150A	SMBJ150CA	PM	EM	150.0	167.00	185.00	1	243.0	2.5	1	X
SMBJ160A	SMBJ160CA	PP	EP	160.0	178.00	197.00	1	259.0	2.3	1	X
SMBJ170A	SMBJ170CA	PR	ER	170.0	189.00	209.00	1	275.0	2.2	1	X
SMBJ180A	SMBJ180CA	PT	ET	180.0	201.00	222.00	1	292.0	2.1	1	X
SMBJ200A	SMBJ200CA	PV	EV	200.0	224.00	247.00	1	324.0	1.9	1	X
SMBJ220A	SMBJ220CA	PX	EX	220.0	246.00	272.00	1	356.0	1.7	1	X
SMBJ250A	SMBJ250CA	PZ	EZ	250.0	279.00	309.00	1	405.0	1.5	1	X
SMBJ300A	SMBJ300CA	QE	FE	300.0	335.00	371.00	1	486.0	1.3	1	X
SMBJ350A	SMBJ350CA	QG	FG	350.0	391.00	432.00	1	567.0	1.1	1	X
SMBJ400A	SMBJ400CA	QK	FK	400.0	447.00	494.00	1	648.0	0.9	1	X
SMBJ440A	SMBJ440CA	QM	FM	440.0	492.00	543.00	1	713.0	0.9	1	X

For bidirectional type having V_R of 10 volts and less, the I_R limit is double.

For parts without A, the V_{BR} is $\pm 10\%$ and V_C is 5% higher than with A parts.

Ratings and Characteristic Curves ($T_A=25^\circ\text{C}$ unless otherwise noted)

Figure 1 - Peak Pulse Power Rating

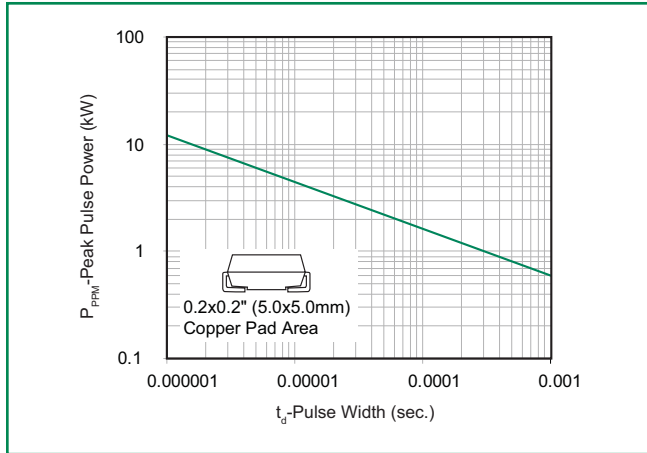

Figure 2 - Pulse Derating Curve

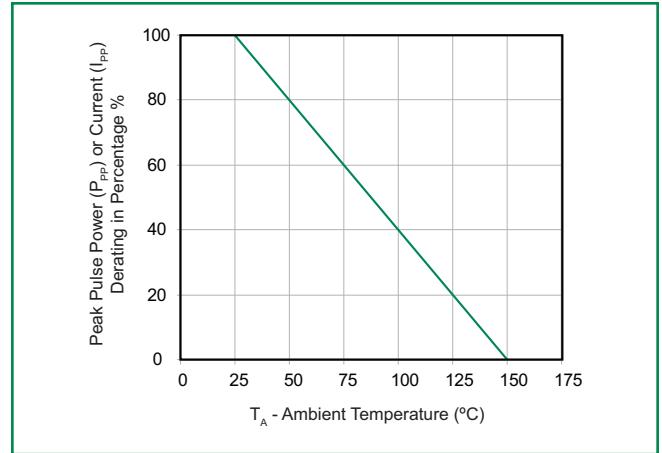

Figure 3 - Pulse Waveform

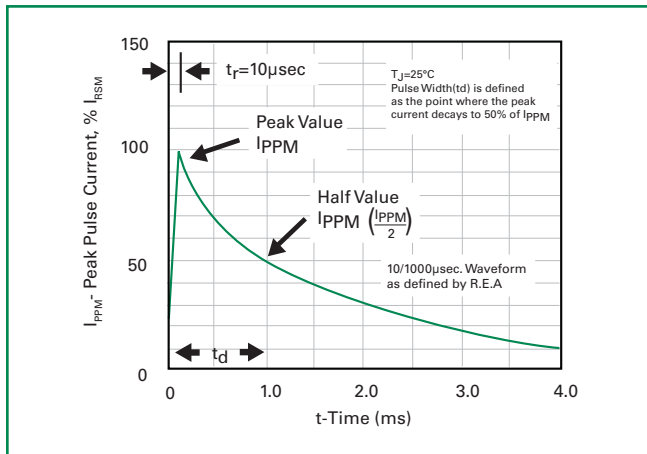

Figure 4 - Typical Junction Capacitance

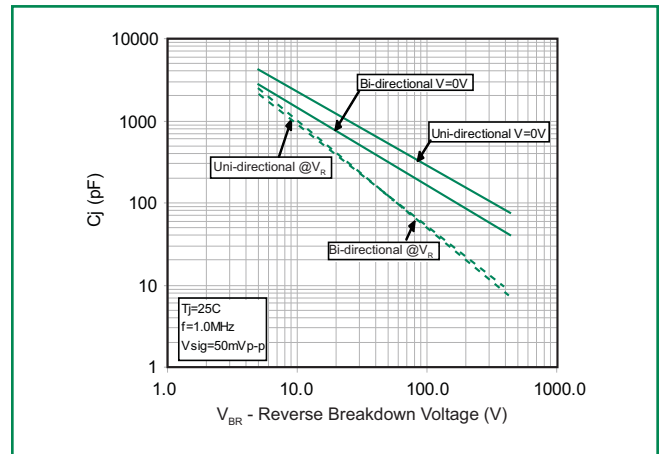

Figure 5 - Steady State Power Dissipation Derating Curve

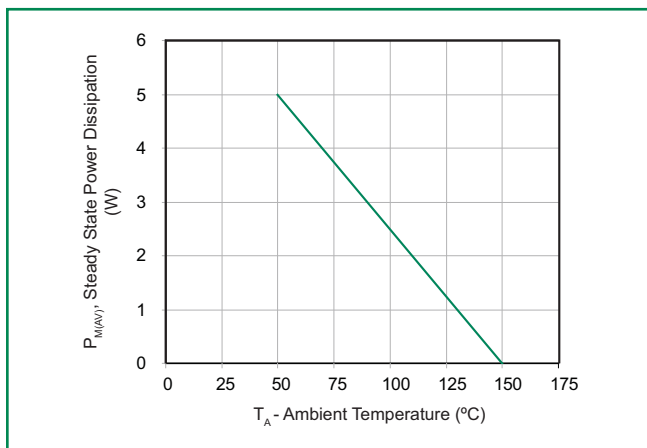
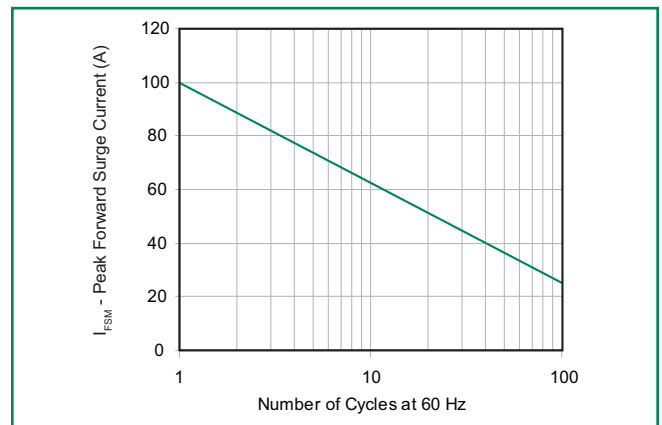
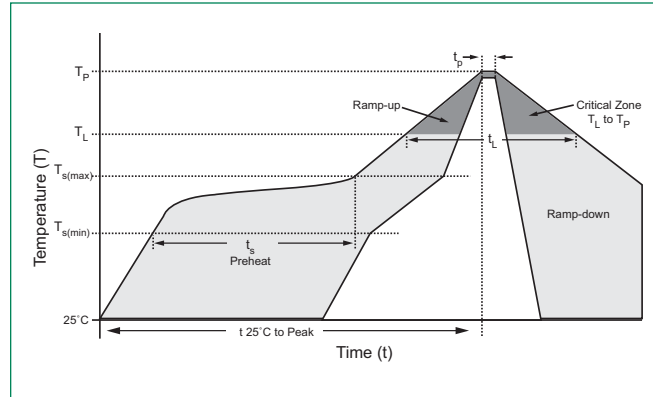

Figure 6 - Maximum Non-Repetitive Peak Forward Surge Current Uni-Directional Only



Soldering Parameters

Reflow Condition		Lead-free assembly
Pre Heat	- Temperature Min ($T_{s(min)}$)	150°C
	- Temperature Max ($T_{s(max)}$)	200°C
	- Time (min to max) (t_s)	60 – 180 secs
Average ramp up rate (Liquidus Temp (T_L) to peak)		3°C/second max
$T_{s(max)}$ to T_L - Ramp-up Rate		3°C/second max
Reflow	- Temperature (T_L) (Liquidus)	217°C
	- Time (min to max) (t_s)	60 – 150 seconds
Peak Temperature (T_p)		260 ^{+0/-5} °C
Time within 5°C of actual peak Temperature (t_p)		20 – 40 seconds
Ramp-down Rate		6°C/second max
Time 25°C to peak Temperature (T_p)		8 minutes Max.
Do not exceed		280°C



Physical Specifications

Weight	0.003 ounce, 0.093 grams
Case	JEDEC DO214AA. Molded plastic body over glass passivated junction
Polarity	Color band denotes cathode except Bidirectional
Terminal	Matte Tin-plated leads, Solderable per JESD22-B102D

Environmental Specifications

Temperature Cycle	JESD22-A104
Pressure Cooker	JESD 22-A102
High Temp. Storage	JESD22-A103
HTRB	JESD22-A108
Thermal Shock	JESD22-A106

Dimensions

DO-214AA (SMB J-Bend)

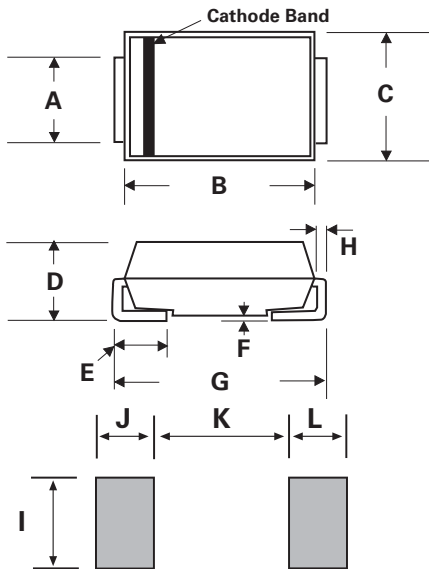

Dimensions	Inches		Millimeters	
	Min	Max	Min	Max
A	0.077	0.086	1.950	2.200
B	0.160	0.180	4.060	4.570
C	0.130	0.155	3.300	3.940
D	0.084	0.096	2.130	2.440
E	0.030	0.060	0.760	1.520
F	-	0.008	-	0.203
G	0.205	0.220	5.210	5.590
H	0.006	0.012	0.152	0.305
I	0.089	-	2.260	-
J	0.085	-	2.160	-
K	-	0.107	-	2.740
L	0.085	-	2.160	-

Part Numbering System

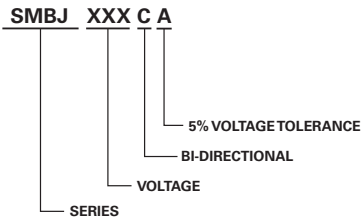

Part Marking System

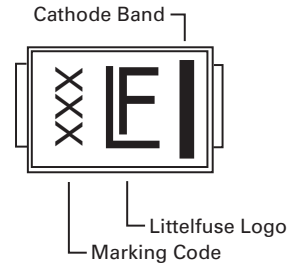

Packaging

Part number	Component Package	Quantity	Packaging Option	Packaging Specification
SMBJxxxXX	DO-214AA	3000	Tape & Reel – 12mm/13" tape	EIA STD RS-481

RoHS P6SMB Series

Agency Approvals

AGENCY	AGENCY FILE NUMBER
	E230531

Maximum Ratings and Thermal Characteristics
 (T_A=25°C unless otherwise noted)

Parameter	Symbol	Value	Unit
Peak Pulse Power Dissipation at T _A =25°C by 10x1000µs waveform (Fig.1)(Note 1), (Note 2)	P _{PPM}	600	W
Power Dissipation on infinite heat sink at T _A =50°C	P _{M(AV)}	5.0	W
Peak Forward Surge Current, 8.3ms Single Half Sine Wave (Note 3)	I _{FSM}	100	A
Maximum Instantaneous Forward Voltage at 50A for Unidirectional only (Note 4)	V _F	3.5V/5.0	V
Operating Junction and Storage Temperature Range	T _J , T _{STG}	-65 to 150	°C
Typical Thermal Resistance Junction to Lead	R _{θJL}	20	°C/W
Typical Thermal Resistance Junction to Ambient	R _{θJA}	100	°C/W

Notes:

1. Non-repetitive current pulse, per Fig. 3 and derated above T_A = 25°C per Fig. 2.
2. Mounted on copper pad area of 0.2x0.2" (5.0 x 5.0mm) to each terminal.
3. Measured on 8.3ms single half sine wave or equivalent square wave for unidirectional device only, duty cycle=4 per minute maximum.
4. V_F<3.5V for V_{BR} ≤ 200V and V_F<5.0V for V_{BR} ≥ 201V.

Description

The P6SMB series is designed specifically to protect sensitive electronic equipment from voltage transients induced by lightning and other transient voltage events.

Features

- RoHS compliant
- For surface mounted applications to optimize board space
- Low profile package
- Built-in strain relief
- Typical maximum temperature coefficient $\Delta V_{BR} = 0.1\% \times V_{BR} @25^\circ\text{C}$
- Glass passivated chip junction
- 600W peak pulse power capability at 10x1000µs waveform, repetition rate (duty cycles):0.01%
- Fast response time: typically less than 1.0ps from 0V to BV min
- Excellent clamping capability
- Low incremental surge resistance
- Typical I_R less than 1µA above 12V
- High Temperature soldering guaranteed: 260°C/40 seconds at terminals
- Plastic package has Underwriters Laboratory Flammability 94V-0
- Matte Tin Lead-free Plated

Applications

TVS devices are ideal for the protection of I/O Interfaces, V_{CC} bus and other vulnerable circuits used in Telecom, Computer, Industrial and Consumer electronic applications.

Electrical Characteristics

Part Number (Uni)	Part Number (Bi)	Marking		Reverse Stand off Voltage V_R (Volts)	Breakdown Voltage V_{BR} (Volts) @ I_T		Test Current I_T (mA)	Maximum Clamping Voltage V_C @ I_{PP} (V)	Maximum Peak Pulse Current I_{PP} (A)	Maximum Reverse Leakage I_R @ V_R (μ A)	Agency Approval 
		UNI	BI		MIN	MAX					
P6SMB6.8A	P6SMB6.8CA	6V8A	6V8C	5.80	6.45	7.14	10	10.5	58.1	1000	X
P6SMB7.5A	P6SMB7.5CA	7V5A	7V5C	6.40	7.13	7.88	10	11.3	54.0	500	X
P6SMB8.2A	P6SMB8.2CA	8V2A	8V2C	7.02	7.79	8.61	10	12.1	50.4	200	X
P6SMB9.1A	P6SMB9.1CA	9V1A	9V1C	7.78	8.65	9.55	1	13.4	45.5	50	X
P6SMB10A	P6SMB10CA	10A	10C	8.55	9.50	10.50	1	14.5	42.1	10	X
P6SMB11A	P6SMB11CA	11A	11C	9.40	10.50	11.60	1	15.6	39.1	5	X
P6SMB12A	P6SMB12CA	12A	12C	10.20	11.40	12.60	1	16.7	36.5	5	X
P6SMB13A	P6SMB13CA	13A	13C	11.10	12.40	13.70	1	18.2	33.5	1	X
P6SMB15A	P6SMB15CA	15A	15C	12.80	14.30	15.80	1	21.2	28.8	1	X
P6SMB16A	P6SMB16CA	16A	16C	13.60	15.20	16.80	1	22.5	27.1	1	X
P6SMB18A	P6SMB18CA	18A	18C	15.30	17.10	18.90	1	25.5	24.2	1	X
P6SMB20A	P6SMB20CA	20A	20C	17.10	19.00	21.00	1	27.7	22.0	1	X
P6SMB22A	P6SMB22CA	22A	22C	18.80	20.90	23.10	1	30.6	19.9	1	X
P6SMB24A	P6SMB24CA	24A	24C	20.50	22.80	25.20	1	33.2	18.4	1	X
P6SMB27A	P6SMB27CA	27A	27C	23.10	25.70	28.40	1	37.5	16.3	1	X
P6SMB30A	P6SMB30CA	30A	30C	25.60	28.50	31.50	1	41.4	14.7	1	X
P6SMB33A	P6SMB33CA	33A	33C	28.20	31.40	34.70	1	45.7	13.3	1	X
P6SMB36A	P6SMB36CA	36A	36C	30.80	34.20	37.80	1	49.9	12.2	1	X
P6SMB39A	P6SMB39CA	39A	39C	33.30	37.10	41.00	1	53.9	11.3	1	X
P6SMB43A	P6SMB43CA	43A	43C	36.80	40.90	45.20	1	59.3	10.3	1	X
P6SMB47A	P6SMB47CA	47A	47C	40.20	44.70	49.40	1	64.8	9.4	1	X
P6SMB51A	P6SMB51CA	51A	51C	43.60	48.50	53.60	1	70.1	8.7	1	X
P6SMB56A	P6SMB56CA	56A	56C	47.80	53.20	58.80	1	77.0	7.9	1	X
P6SMB62A	P6SMB62CA	62A	62C	53.00	58.90	65.10	1	85.0	7.2	1	X
P6SMB68A	P6SMB68CA	68A	68C	58.10	64.60	71.40	1	92.0	6.6	1	X
P6SMB75A	P6SMB75CA	75A	75C	64.10	71.30	78.80	1	103.0	5.9	1	X
P6SMB82A	P6SMB82CA	82A	82C	70.10	77.90	86.10	1	113.0	5.4	1	X
P6SMB91A	P6SMB91CA	91A	91C	77.80	86.50	95.50	1	125.0	4.9	1	X
P6SMB100A	P6SMB100CA	100A	100C	85.50	95.00	105.00	1	137.0	4.5	1	X
P6SMB110A	P6SMB110CA	110A	110C	94.00	105.00	116.00	1	152.0	4.0	1	X
P6SMB120A	P6SMB120CA	120A	120C	102.00	114.00	126.00	1	165.0	3.7	1	X
P6SMB130A	P6SMB130CA	130A	130C	111.00	124.00	137.00	1	179.0	3.4	1	X
P6SMB150A	P6SMB150CA	150A	150C	128.00	143.00	158.00	1	207.0	2.9	1	X
P6SMB160A	P6SMB160CA	160A	160C	136.00	152.00	168.00	1	219.0	2.8	1	X
P6SMB170A	P6SMB170CA	170A	170C	145.00	162.00	179.00	1	234.0	2.6	1	X
P6SMB180A	P6SMB180CA	180A	180C	154.00	171.00	189.00	1	246.0	2.5	1	X
P6SMB200A	P6SMB200CA	200A	200C	171.00	190.00	210.00	1	274.0	2.2	1	X
P6SMB220A	P6SMB220CA	220A	220C	185.00	209.00	231.00	1	328.0	1.9	1	X
P6SMB250A	P6SMB250CA	250A	250C	214.00	237.00	263.00	1	344.0	1.8	1	X
P6SMB300A	P6SMB300CA	300A	300C	256.00	285.00	315.00	1	414.0	1.5	1	X
P6SMB350A	P6SMB350CA	350A	350C	300.00	332.00	368.00	1	482.0	1.3	1	X
P6SMB400A	P6SMB400CA	400A	400C	342.00	380.00	420.00	1	548.0	1.1	1	X
P6SMB440A	P6SMB440CA	440A	440C	376.00	418.00	462.00	1	602.0	1.0	1	X
P6SMB480A	P6SMB480CA	480A	480C	408.00	456.00	504.00	1	658.0	0.9	1	
P6SMB510A	P6SMB510CA	510A	510C	434.00	485.00	535.00	1	698.0	0.9	1	
P6SMB530A	P6SMB530CA	530A	530C	477.00	503.50	556.50	1	725.0	0.8	1	
P6SMB540A	P6SMB540CA	540A	540C	486.00	513.00	567.00	1	740.0	0.8	1	
P6SMB550A	P6SMB550CA	550A	550C	495.00	522.50	577.50	1	760.0	0.8	1	

For bidirectional type having V_R of 10 volts and less, the I_R limit is double.

The available parts are "A" type only, the parts without A (V_{BR} is $\pm 10\%$) is not available.

Ratings and Characteristic Curves ($T_A=25^\circ\text{C}$ unless otherwise noted)

Figure 1 - Peak Pulse Power Rating

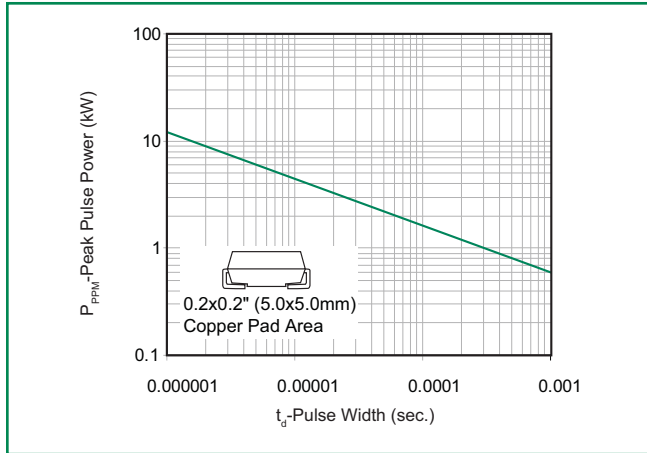

Figure 2 - Pulse Derating Curve

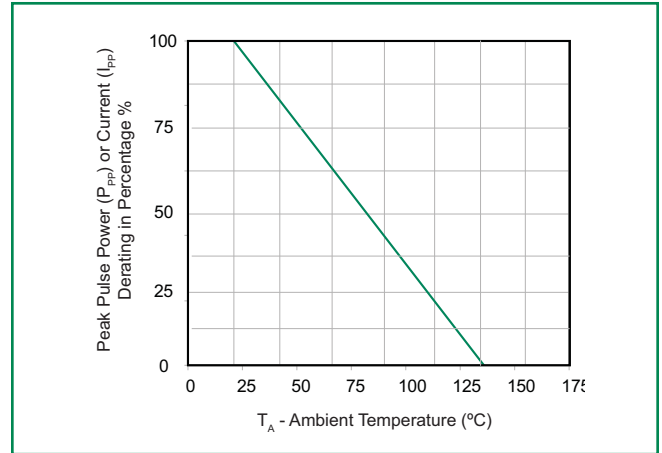

Figure 3 - Pulse Waveform

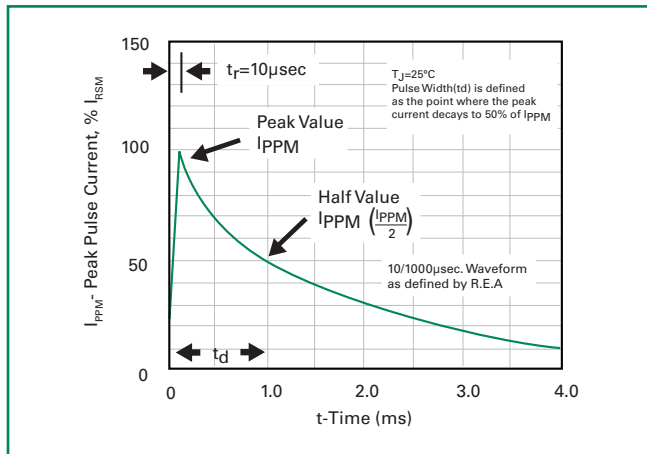

Figure 4 - Typical Junction Capacitance

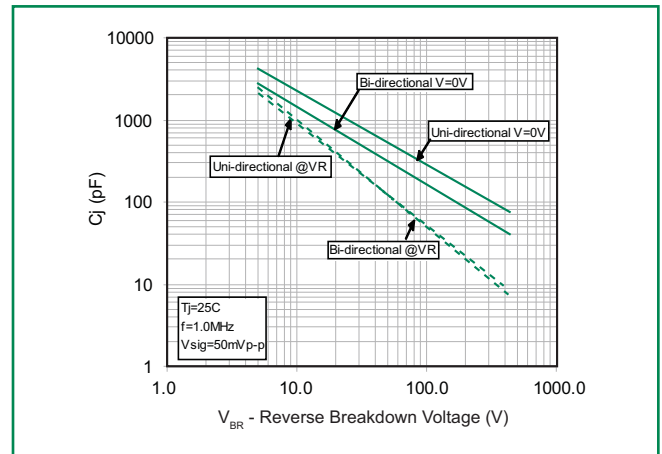

Figure 5 - Steady State Power Dissipation Derating Curve

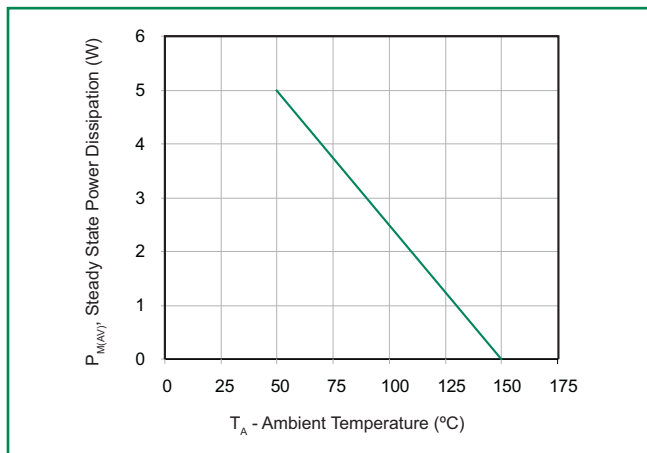
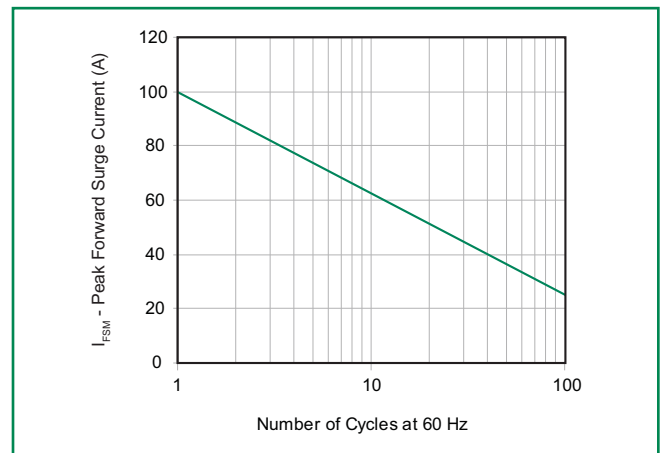
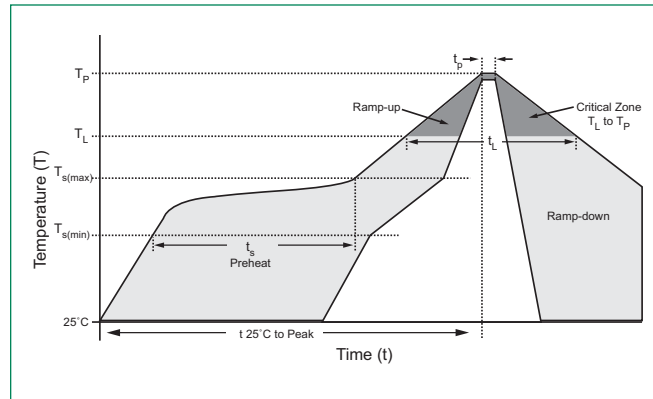

Figure 6 - Maximum Non-Repetitive Peak Forward Surge Current Uni-Directional Only



Soldering Parameters

Reflow Condition		Lead-free assembly
Pre Heat	- Temperature Min ($T_{s(min)}$)	150°C
	- Temperature Max ($T_{s(max)}$)	200°C
	- Time (min to max) (t_s)	60 – 180 secs
Average ramp up rate (Liquidus Temp (T_L) to peak)		3°C/second max
$T_{s(max)}$ to T_L - Ramp-up Rate		3°C/second max
Reflow	- Temperature (T_L) (Liquidus)	217°C
	- Time (min to max) (t_s)	60 – 150 seconds
Peak Temperature (T_p)		260 ^{+0/-5} °C
Time within 5°C of actual peak Temperature (t_p)		20 – 40 seconds
Ramp-down Rate		6°C/second max
Time 25°C to peak Temperature (T_p)		8 minutes Max.
Do not exceed		280°C



Physical Specifications

Weight	0.003 ounce, 0.093 grams
Case	JEDEC DO214AA. Molded plastic body over glass passivated junction
Polarity	Color band denotes cathode except Bidirectional.
Terminal	Matte Tin-plated leads, Solderable per JESD22-B102D

Environmental Specifications

Temperature Cycle	JESD22-A104
Pressure Cooker	JESD 22-A102
High Temp. Storage	JESD22-A103
HTRB	JESD22-A108
Thermal Shock	JESD22-A106

Dimensions

DO-214AA (SMB J-Bend)

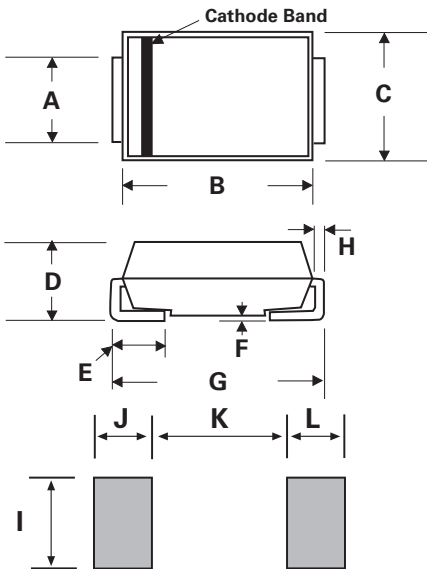

Dimensions	Inches		Millimeters	
	Min	Max	Min	Max
A	0.077	0.086	1.950	2.200
B	0.160	0.180	4.060	4.570
C	0.130	0.155	3.300	3.940
D	0.084	0.096	2.130	2.440
E	0.030	0.060	0.760	1.520
F	-	0.008	-	0.203
G	0.205	0.220	5.210	5.590
H	0.006	0.012	0.152	0.305
I	0.089	-	2.260	-
J	0.085	-	2.160	-
K	-	0.107	-	2.740
L	0.085	-	2.160	-

Part Numbering System

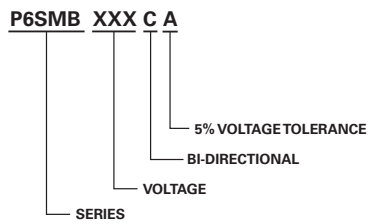

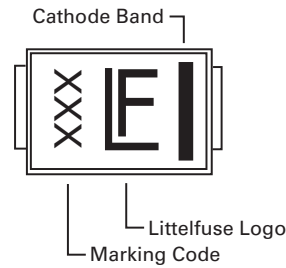

Part Marking System

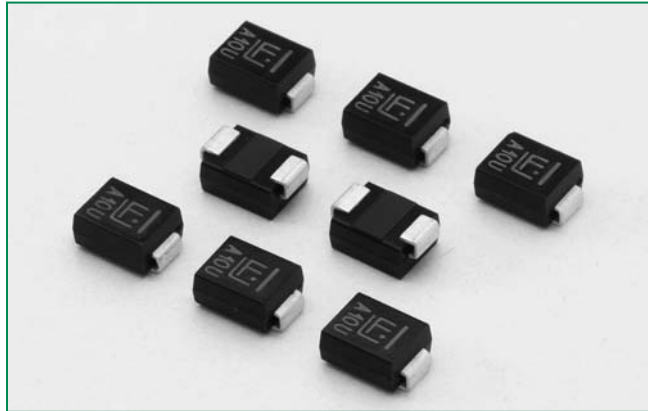

Packaging

Part number	Component Package	Quantity	Packaging Option	Packaging Specification
P6SMBxxxXX	DO-214AA	3000	Tape & Reel – 12mm/13" tape	EIA STD RS-481

RoHS 1KSMB Series

Agency Approvals

AGENCY	AGENCY FILE NUMBER
	E128662

Maximum Ratings and Thermal Characteristics
 (T_A=25°C unless otherwise noted)

Parameter	Symbol	Value	Unit
Peak Pulse Power Dissipation at T _A =25°C by 10x1000µs waveform (Fig.1)(Note 1), (Note 2)	P _{PPM}	1000	W
Power Dissipation on infinite heat sink at T _A =50°C	P _{M(AV)}	5.0	W
Peak Forward Surge Current, 8.3ms Single Half Sine Wave (Note 3)	I _{FSM}	100	A
Maximum Instantaneous Forward Voltage at 50A for Unidirectional only (Note 4)	V _F	3.5V/5.0	V
Operating Junction and Storage Temperature Range	T _J , T _{STG}	-65 to 150	°C
Typical Thermal Resistance Junction to Lead	R _{θJL}	20	°C/W
Typical Thermal Resistance Junction to Ambient	R _{θJA}	100	°C/W

Notes:

1. Non-repetitive current pulse, per Fig. 3 and derated above T_A = 25°C per Fig. 2.
2. Mounted on copper pad area of 0.2x0.2" (5.0 x 5.0mm) to each terminal.
3. Measured on 8.3ms single half sine wave or equivalent square wave for unidirectional device only, duty cycle=4 per minute maximum.
4. V_F<3.5V for V_{BR} ≤ 50V and V_F<5.0V for V_{BR} ≥ 51V.

Description

The 1KSMB series is designed specifically to protect sensitive electronic equipment from voltage transients induced by lightning and other transient voltage events.

Features

- RoHS compliant
- For surface mounted applications to optimize board space
- Low profile package
- Built-in strain relief
- Typical maximum temperature coefficient $\Delta V_{BR} = 0.1\% \times V_{BR} @ 25^\circ\text{C}$
- Glass passivated chip junction
- 1000W peak pulse power capability at 10x1000µs waveform, repetition rate (duty cycles):0.01%
- Fast response time: typically less than 1.0ps from 0V to BV min
- Excellent clamping capability
- Low incremental surge resistance
- Typical I_R less than 1µA above 12V
- High Temperature soldering guaranteed: 260°C/40 seconds at terminals
- Plastic package has Underwriters Laboratory Flammability 94V-0
- Matte Tin Lead-free Plated
- Available in breakdown Voltage from 6.8V to 160V specially designed for automotive applications
- Offers High-Surge rating in compact package: bridges the gap between 600W and 1.5KW

Applications

TVS devices are ideal for the protection of I/O Interfaces, V_{CC} bus and other vulnerable circuits used in Telecom, Computer, Industrial and Consumer electronic applications.

Electrical Characteristics

Part Number (Uni)	Part Number (Bi)	Marking		Reverse Stand off Voltage V_R (Volts)	Breakdown Voltage V_{BR} (Volts) @ I_T		Test Current I_T (mA)	Maximum Clamping Voltage V_C @ I_{PP} (V)	Maximum Peak Pulse Current I_{PP} (A)	Maximum Reverse Leakage I_R @ V_R (μ A)	Agency Approval 
		UNI	BI		MIN	MAX					
1KSMB6.8A	1KSMB6.8CA	A10A	N10A	5.80	6.45	7.14	10	10.5	95.2	900	x
1KSMB7.5A	1KSMB7.5CA	A10B	N10B	6.40	7.13	7.88	10	11.3	88.5	400	x
1KSMB8.2A	1KSMB8.2CA	A10C	N10C	7.02	7.79	8.61	10	12.1	82.6	180	x
1KSMB9.1A	1KSMB9.1CA	A10D	N10D	7.78	8.65	9.55	1	13.4	74.6	45	x
1KSMB10A	1KSMB10CA	A10E	N10E	8.55	9.50	10.50	1	14.5	69.0	8	x
1KSMB11A	1KSMB11CA	A10F	N10F	9.40	10.50	11.60	1	15.6	64.1	4	x
1KSMB12A	1KSMB12CA	A10G	N10G	10.20	11.40	12.60	1	16.7	59.9	1	x
1KSMB13A	1KSMB13CA	A10H	N10H	11.10	12.40	13.70	1	18.2	54.9	1	x
1KSMB15A	1KSMB15CA	A10I	N10I	12.80	14.30	15.80	1	21.2	47.2	1	x
1KSMB16A	1KSMB16CA	A10J	N10J	13.60	15.20	16.80	1	22.5	44.4	1	x
1KSMB18A	1KSMB18CA	A10K	N10K	15.30	17.10	18.90	1	25.5	39.2	1	x
1KSMB20A	1KSMB20CA	A10L	N10L	17.10	19.00	21.00	1	27.7	36.1	1	x
1KSMB22A	1KSMB22CA	A10M	N10M	18.80	20.90	23.10	1	30.6	32.7	1	x
1KSMB24A	1KSMB24CA	A10N	N10N	20.50	22.80	25.20	1	33.2	30.1	1	x
1KSMB27A	1KSMB27CA	A10O	N10O	23.10	25.70	28.40	1	37.5	26.7	1	x
1KSMB30A	1KSMB30CA	A10P	N10P	25.60	28.50	31.50	1	41.4	24.2	1	x
1KSMB33A	1KSMB33CA	A10Q	N10Q	28.20	31.40	34.70	1	45.7	21.9	1	x
1KSMB36A	1KSMB36CA	A10R	N10R	30.80	34.20	37.80	1	49.9	20.0	1	x
1KSMB39A	1KSMB39CA	A10S	N10S	33.30	37.10	41.00	1	53.9	18.6	1	x
1KSMB43A	1KSMB43CA	A10T	N10T	36.80	40.90	45.20	1	59.3	16.9	1	x
1KSMB47A	1KSMB47CA	A10U	N10U	40.20	44.70	49.40	1	64.8	15.4	1	x
1KSMB51A	1KSMB51CA	A10V	N10V	43.60	48.50	53.60	1	70.1	14.3	1	x
1KSMB56A	1KSMB56CA	A10W	N10W	47.80	53.20	58.80	1	77.0	13.0	1	x
1KSMB62A	1KSMB62CA	A10X	N10X	53.00	58.90	65.10	1	85.0	11.8	1	x
1KSMB68A	1KSMB68CA	A10Y	N10Y	58.10	64.60	71.40	1	92.0	10.9	1	x
1KSMB75A	1KSMB75CA	A10Z	N10Z	64.10	71.30	78.80	1	103.0	9.7	1	x
1KSMB82A	1KSMB82CA	B10A	O10A	70.10	77.90	86.10	1	113.0	8.8	1	x
1KSMB91A	1KSMB91CA	B10B	O10B	77.80	86.50	95.50	1	125.0	8.0	1	x
1KSMB100A	1KSMB100CA	B10C	O10C	85.50	95.00	105.00	1	137.0	7.3	1	x
1KSMB110A	1KSMB110CA	B10D	O10D	94.00	105.00	116.00	1	152.0	6.6	1	
1KSMB120A	1KSMB120CA	B10E	O10E	102.00	114.00	126.00	1	165.0	6.1	1	
1KSMB130A	1KSMB130CA	B10F	O10F	111.00	124.00	137.00	1	179.0	5.6	1	
1KSMB150A	1KSMB150CA	B10G	O10G	128.00	143.00	158.00	1	207.0	4.8	1	
1KSMB160A	1KSMB160CA	B10H	O10H	136.00	152.00	168.00	1	219.0	4.6	1	

For bidirectional type having V_R of 10 volts and less, the I_R limit is double.

The available parts are "A" type only, the parts without A (V_{BR} is $\pm 10\%$) is not available.

Ratings and Characteristic Curves ($T_A=25^\circ\text{C}$ unless otherwise noted)

Figure 1 - Peak Pulse Power Rating Curve

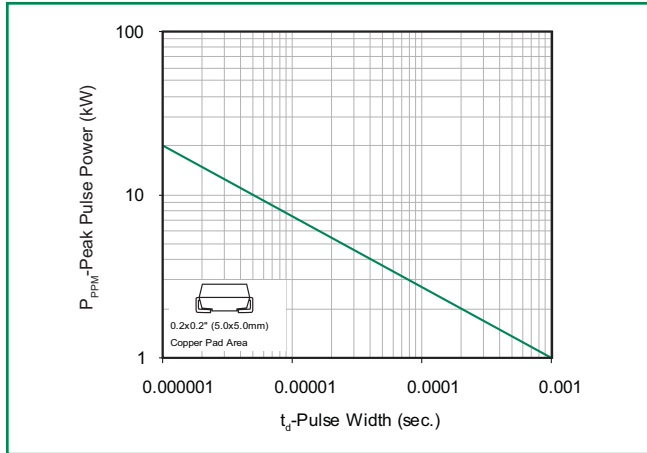

Figure 2 - Pulse Derating Curve

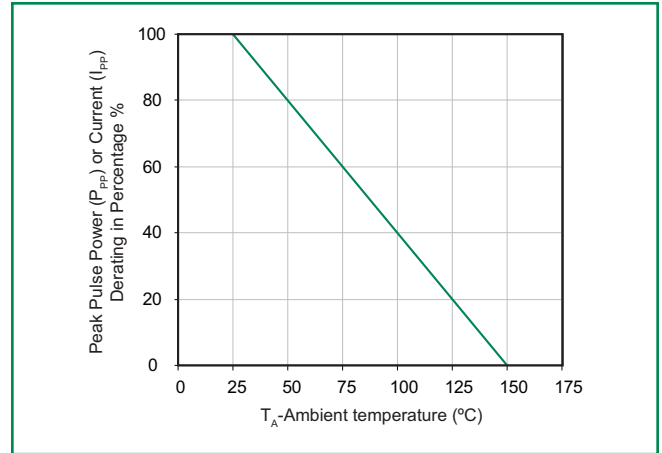

Figure 3 - Pulse Waveform

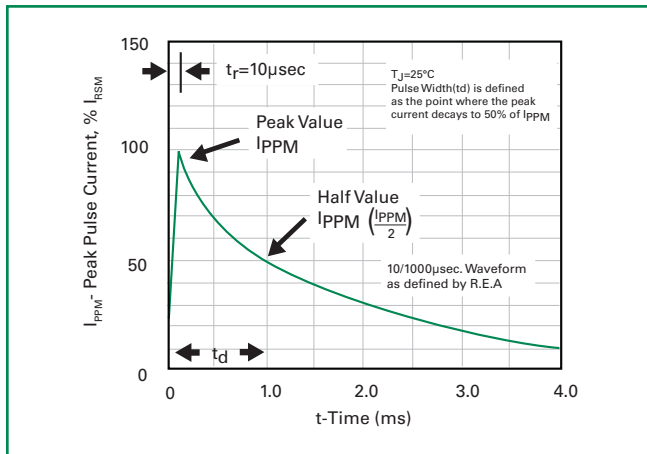

Figure 4 - Typical Junction Capacitance

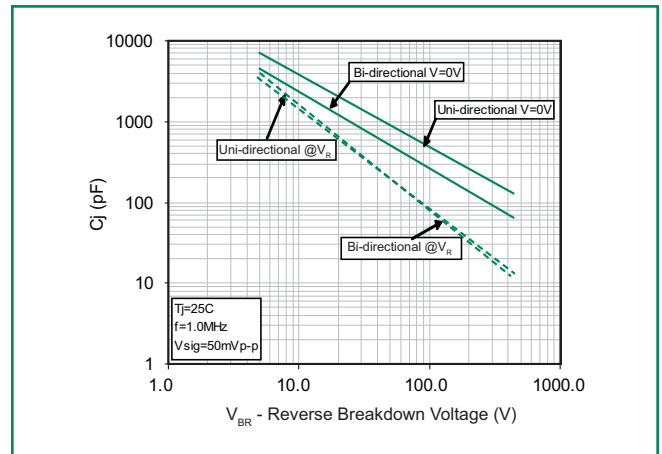

Figure 5 - Steady State Power Dissipation Derating Curve

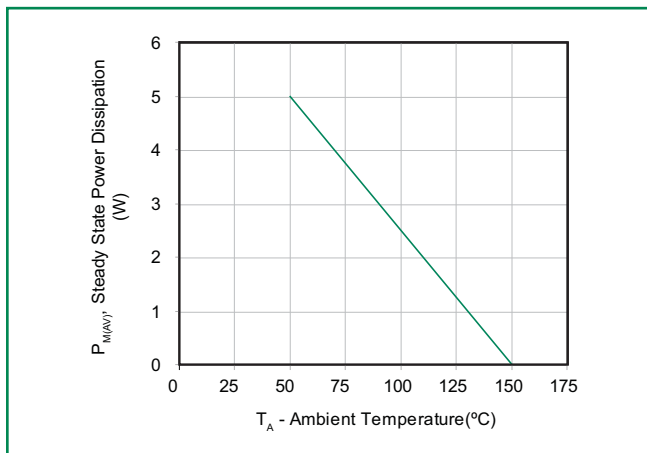
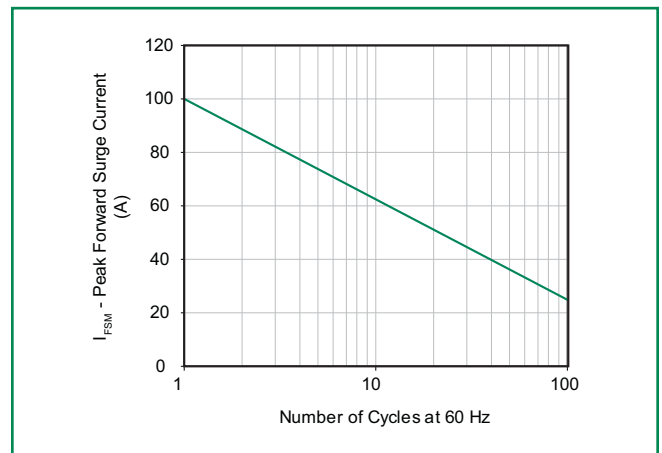
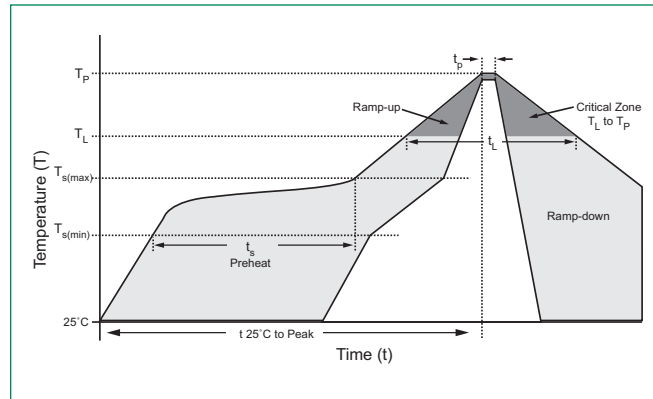

Figure 6 - Maximum Non-Repetitive Peak Forward Surge Current Uni-Directional Only



Soldering Parameters

Reflow Condition		Lead-free assembly
Pre Heat	- Temperature Min ($T_{s(min)}$)	150°C
	- Temperature Max ($T_{s(max)}$)	200°C
	- Time (min to max) (t_s)	60 – 180 secs
Average ramp up rate (Liquidus Temp (T_L) to peak)		3°C/second max
$T_{s(max)}$ to T_L - Ramp-up Rate		3°C/second max
Reflow	- Temperature (T_L) (Liquidus)	217°C
	- Time (min to max) (t_s)	60 – 150 seconds
Peak Temperature (T_p)		260 ^{+0/-5} °C
Time within 5°C of actual peak Temperature (t_p)		20 – 40 seconds
Ramp-down Rate		6°C/second max
Time 25°C to peak Temperature (T_p)		8 minutes Max.
Do not exceed		280°C



Physical Specifications

Weight	0.003 ounce, 0.093 grams
Case	JEDEC DO214AA. Molded plastic body over glass passivated junction
Polarity	Color band denotes cathode except Bidirectional.
Terminal	Matte Tin-plated leads, Solderable per JESD22-B102D

Environmental Specifications

Temperature Cycle	JESD22-A104
Pressure Cooker	JESD 22-A102
High Temp. Storage	JESD22-A103
HTRB	JESD22-A108
Thermal Shock	JESD22-A106

Dimensions

DO-214AA (SMB J-Bend)

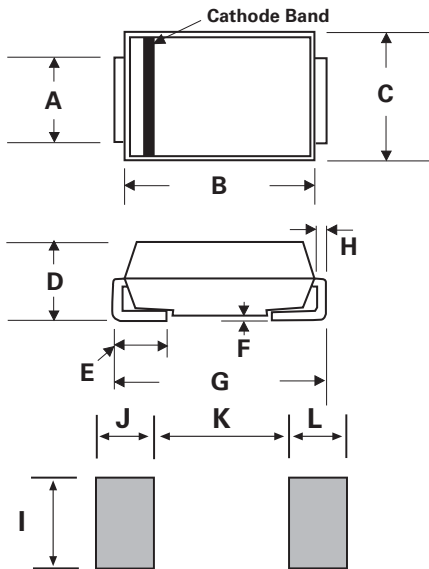

Dimensions	Inches		Millimeters	
	Min	Max	Min	Max
A	0.077	0.086	1.950	2.200
B	0.160	0.180	4.060	4.570
C	0.130	0.155	3.300	3.940
D	0.084	0.096	2.130	2.440
E	0.030	0.060	0.760	1.520
F	-	0.008	-	0.203
G	0.205	0.220	5.210	5.590
H	0.006	0.012	0.152	0.305
I	0.089	-	2.260	-
J	0.085	-	2.160	-
K	-	0.107	-	2.740
L	0.085	-	2.160	-

Part Numbering System

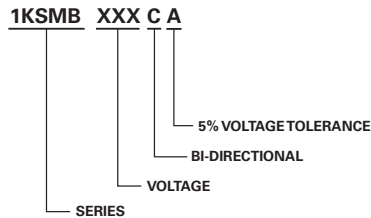

Part Marking System

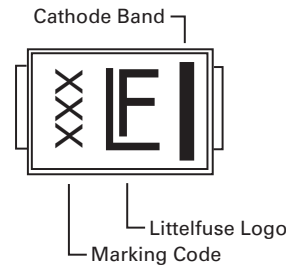

Packaging

Part number	Component Package	Quantity	Packaging Option	Packaging Specification
1KSMBxxxXX	DO-214AA	3000	Tape & Reel – 12mm/13" tape	EIA STD RS-481

RoHS SMCJ Series

Agency Approvals

AGENCY	AGENCY FILE NUMBER
	E230531

**Maximum Ratings and Thermal Characteristics
(T_A=25°C unless otherwise noted)**

Parameter	Symbol	Value	Unit
Peak Pulse Power Dissipation at T _A =25°C by 10x1000µs waveform (Fig.1)(Note 1), (Note 2)	P _{PPM}	1500	W
Power Dissipation on infinite heat sink at T _A =50°C	P _{M(AV)}	6.5	W
Peak Forward Surge Current, 8.3ms Single Half Sine Wave (Note 3)	I _{FSM}	200	A
Maximum Instantaneous Forward Voltage at 100A for Unidirectional only (Note 4)	V _F	3.5/5.0	V
Operating Junction and Storage Temperature Range	T _J , T _{STG}	-65 to 150	°C
Typical Thermal Resistance Junction to Lead	R _{θJL}	15	°C/W
Typical Thermal Resistance Junction to Ambient	R _{θJA}	75	°C/W

Notes:

1. Non-repetitive current pulse, per Fig. 3 and derated above T_A = 25°C per Fig. 2.
2. Mounted on copper pad area of 0.31x0.31" (8.0 x 8.0mm) to each terminal.
3. Measured on 8.3ms single half sine wave or equivalent square wave for unidirectional device only, duty cycle=4 per minute maximum.
4. V_F<3.5V for V_{BR} ≤ 200V and V_F<5.0V for V_{BR} ≥ 201V.

Description

The SMCJ series is designed specifically to protect sensitive electronic equipment from voltage transients induced by lightning and other transient voltage events.

Features

- RoHS compliant
- For surface mounted applications to optimize board space
- Low profile package
- Built-in strain relief
- Typical maximum temperature coefficient $\Delta V_{BR} = 0.1\% \times V_{BR}$ @25°C
- Glass passivated chip junction
- 1500W peak pulse power capability at 10x1000µs waveform, repetition rate (duty cycles):0.01%
- Fast response time: typically less than 1.0ps from 0V to BV min
- Excellent clamping capability
- Low incremental surge resistance
- Typical I_R less than 1µA above 12V
- High Temperature soldering guaranteed: 260°C/40 seconds at terminals
- Plastic package has Underwriters Laboratory Flammability 94V-O
- Matte Tin Lead-free Plated

Applications

TVS devices are ideal for the protection of I/O Interfaces, V_{CC} bus and other vulnerable circuits used in Telecom, Computer, Industrial and Consumer electronic applications.

Electrical Characteristics

Part Number (Uni)	Part Number (Bi)	Marking		Reverse Stand off Voltage V_R (Volts)	Breakdown Voltage V_{BR} (Volts) @ I_T		Test Current I_T (mA)	Maximum Clamping Voltage V_C @ I_{PP} (V)	Maximum Peak Pulse Current I_{PP} (A)	Maximum Reverse Leakage I_R @ V_R (μ A)	Agency Approval 
		UNI	BI		MIN	MAX					
SMCJ5.0A	SMCJ5.0CA	GDE	BDE	5.0	6.40	7.00	10	9.2	163.0	800	X
SMCJ6.0A	SMCJ6.0CA	GDG	BDG	6.0	6.67	7.37	10	10.3	145.7	800	X
SMCJ6.5A	SMCJ6.5CA	GDK	BDK	6.5	7.22	7.98	10	11.2	134.0	500	X
SMCJ7.0A	SMCJ7.0CA	GDM	BDM	7.0	7.78	8.60	10	12.0	125.0	200	X
SMCJ7.5A	SMCJ7.5CA	GDP	BDP	7.5	8.33	9.21	1	12.9	116.3	100	X
SMCJ8.0A	SMCJ8.0CA	GDR	BDR	8.0	8.89	9.83	1	13.6	110.3	50	X
SMCJ8.5A	SMCJ8.5CA	GDT	BDT	8.5	9.44	10.40	1	14.4	104.2	20	X
SMCJ9.0A	SMCJ9.0CA	GDV	BDV	9.0	10.00	11.10	1	15.4	97.4	10	X
SMCJ10A	SMCJ10CA	GDX	BDX	10.0	11.10	12.30	1	17.0	88.3	5	X
SMCJ11A	SMCJ11CA	GDZ	BDZ	11.0	12.20	13.50	1	18.2	82.5	1	X
SMCJ12A	SMCJ12CA	GEE	BEE	12.0	13.30	14.70	1	19.9	75.4	1	X
SMCJ13A	SMCJ13CA	GEG	BEG	13.0	14.40	15.90	1	21.5	69.8	1	X
SMCJ14A	SMCJ14CA	GEK	BEK	14.0	15.60	17.20	1	23.2	64.7	1	X
SMCJ15A	SMCJ15CA	GEM	BEM	15.0	16.70	18.50	1	24.4	61.5	1	X
SMCJ16A	SMCJ16CA	GEP	BEP	16.0	17.80	19.70	1	26.0	57.7	1	X
SMCJ17A	SMCJ17CA	GER	BER	17.0	18.90	20.90	1	27.6	54.4	1	X
SMCJ18A	SMCJ18CA	GET	BET	18.0	20.00	22.10	1	29.2	51.4	1	X
SMCJ20A	SMCJ20CA	GEV	BEV	20.0	22.20	24.50	1	32.4	46.3	1	X
SMCJ22A	SMCJ22CA	GEX	BEX	22.0	24.40	26.90	1	35.5	42.3	1	X
SMCJ24A	SMCJ24CA	GEZ	BEZ	24.0	26.70	29.50	1	38.9	38.6	1	X
SMCJ26A	SMCJ26CA	GFE	BEF	26.0	28.90	31.90	1	42.1	35.7	1	X
SMCJ28A	SMCJ28CA	GFG	BEF	28.0	31.10	34.40	1	45.4	33.1	1	X
SMCJ30A	SMCJ30CA	GFK	BEF	30.0	33.30	36.80	1	48.4	31.0	1	X
SMCJ33A	SMCJ33CA	GFM	BFM	33.0	36.70	40.60	1	53.3	28.2	1	X
SMCJ36A	SMCJ36CA	GFP	BFP	36.0	40.00	44.20	1	58.1	25.9	1	X
SMCJ40A	SMCJ40CA	GFR	BFR	40.0	44.40	49.10	1	64.5	23.3	1	X
SMCJ43A	SMCJ43CA	GFT	BFT	43.0	47.80	52.80	1	69.4	21.7	1	X
SMCJ45A	SMCJ45CA	GFV	BFV	45.0	50.00	55.30	1	72.7	20.6	1	X
SMCJ48A	SMCJ48CA	GFX	BFX	48.0	53.30	58.90	1	77.4	19.4	1	X
SMCJ51A	SMCJ51CA	GFZ	BFZ	51.0	56.70	62.70	1	82.4	18.2	1	X
SMCJ54A	SMCJ54CA	GGE	BGE	54.0	60.00	66.30	1	87.1	17.3	1	X
SMCJ58A	SMCJ58CA	GGG	BGG	58.0	64.40	71.20	1	93.6	16.1	1	X
SMCJ60A	SMCJ60CA	GGK	BGK	60.0	66.70	73.70	1	96.8	15.5	1	X
SMCJ64A	SMCJ64CA	GGM	BGM	64.0	71.10	78.60	1	103.0	14.6	1	X
SMCJ70A	SMCJ70CA	GGP	BGP	70.0	77.80	86.00	1	113.0	13.3	1	X
SMCJ75A	SMCJ75CA	GGR	BGR	75.0	83.30	92.10	1	121.0	12.4	1	X
SMCJ78A	SMCJ78CA	GGT	BGT	78.0	86.70	95.80	1	126.0	11.9	1	X
SMCJ85A	SMCJ85CA	GGV	BGV	85.0	94.40	104.00	1	137.0	11.0	1	X
SMCJ90A	SMCJ90CA	GGX	BGX	90.0	100.00	111.00	1	146.0	10.3	1	X
SMCJ100A	SMCJ100CA	GGZ	BGZ	100.0	111.00	123.00	1	162.0	9.3	1	X
SMCJ110A	SMCJ110CA	GHE	BHE	110.0	122.00	135.00	1	177.0	8.5	1	X
SMCJ120A	SMCJ120CA	GHG	BHG	120.0	133.00	147.00	1	193.0	7.8	1	X
SMCJ130A	SMCJ130CA	GHK	BHK	130.0	144.00	159.00	1	209.0	7.2	1	X
SMCJ150A	SMCJ150CA	GHM	BHM	150.0	167.00	185.00	1	243.0	6.2	1	X
SMCJ160A	SMCJ160CA	GHP	BHP	160.0	178.00	197.00	1	259.0	5.8	1	X
SMCJ170A	SMCJ170CA	GHR	BHR	170.0	189.00	209.00	1	275.0	5.5	1	X
SMCJ180A	SMCJ180CA	GHT	BHT	180.0	201.00	222.00	1	292.0	5.1	1	X
SMCJ200A	SMCJ200CA	GHV	BHV	200.0	224.00	247.00	1	324.0	4.6	1	X
SMCJ220A	SMCJ220CA	GHX	BHX	220.0	246.00	272.00	1	356.0	4.2	1	X
SMCJ250A	SMCJ250CA	GHZ	BHZ	250.0	279.00	309.00	1	405.0	3.7	1	X
SMCJ300A	SMCJ300CA	GJE	BJE	300.0	335.00	371.00	1	486.0	3.1	1	X
SMCJ350A	SMCJ350CA	GJG	BJG	350.0	391.00	432.00	1	567.0	2.6	1	X
SMCJ400A	SMCJ400CA	GJK	BJK	400.0	447.00	494.00	1	648.0	2.3	1	X
SMCJ440A	SMCJ440CA	GJM	BJM	440.0	492.00	543.00	1	713.0	2.1	1	X

For bidirectional type having V_R of 10 volts and less, the I_R limit is double.

For parts without A, the V_{BR} is $\pm 10\%$ and V_C is 5% higher than with A parts.

Ratings and Characteristic Curves ($T_A=25^\circ\text{C}$ unless otherwise noted)

Figure 1 - Peak Pulse Power Rating

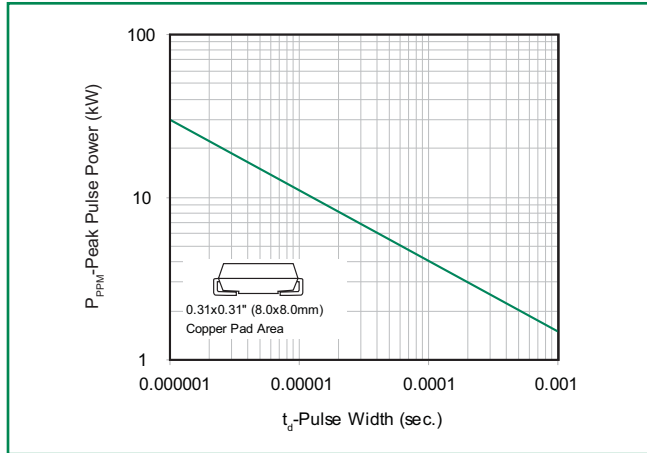

Figure 2 - Pulse Derating Curve

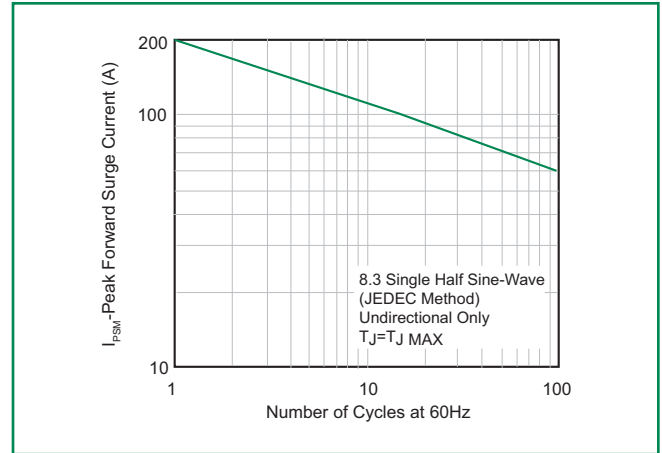

Figure 3 - Pulse Waveform

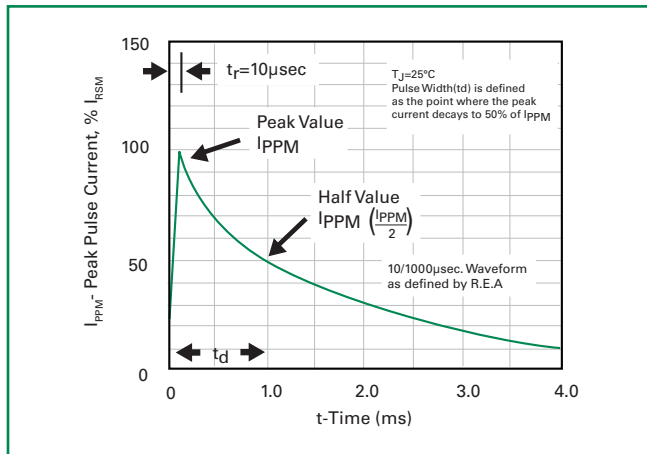

Figure 4 - Typical Junction Capacitance

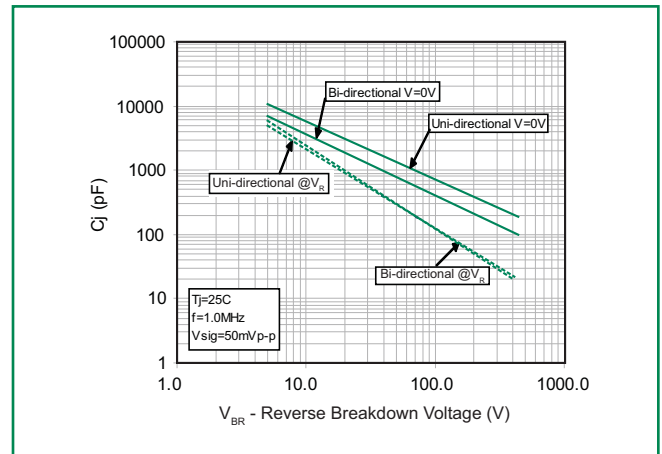

Figure 5 - Steady State Power Dissipation Derating Curve

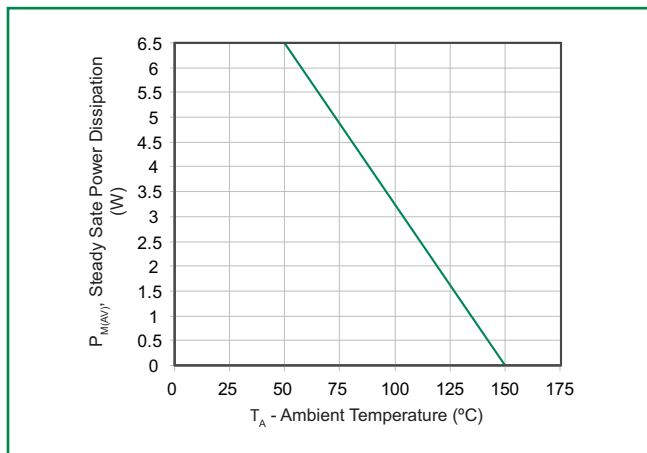
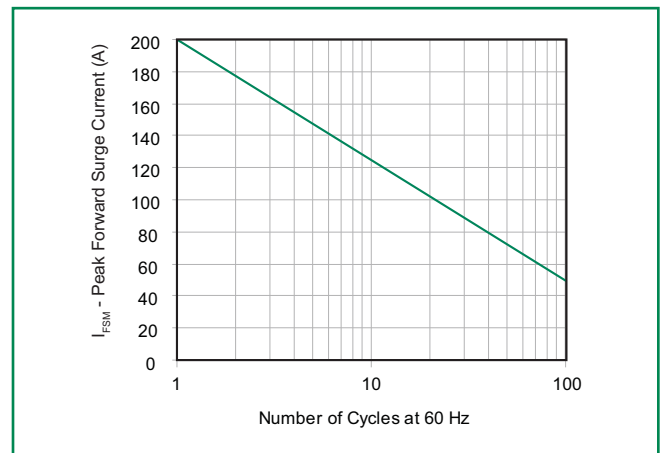
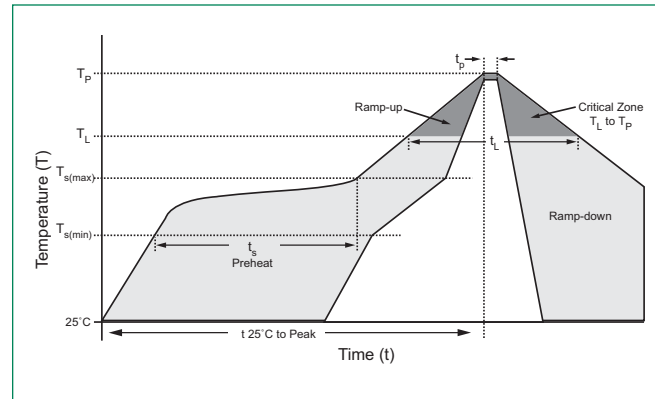

Figure 6 - Maximum Non-Repetitive Peak Forward Surge Current Uni-Directional Only



Soldering Parameters

Reflow Condition		Lead-free assembly
Pre Heat	- Temperature Min ($T_{s(min)}$)	150°C
	- Temperature Max ($T_{s(max)}$)	200°C
	- Time (min to max) (t_s)	60 – 180 secs
Average ramp up rate (Liquidus Temp (T_L) to peak)		3°C/second max
$T_{s(max)}$ to T_L - Ramp-up Rate		3°C/second max
Reflow	- Temperature (T_L) (Liquidus)	217°C
	- Time (min to max) (t_s)	60 – 150 seconds
Peak Temperature (T_p)		260 ^{+0/-5} °C
Time within 5°C of actual peak Temperature (t_p)		20 – 40 seconds
Ramp-down Rate		6°C/second max
Time 25°C to peak Temperature (T_p)		8 minutes Max.
Do not exceed		280°C



Physical Specifications

Weight	0.007 ounce, 0.21 grams
Case	JEDEC DO214AB. Molded plastic body over glass passivated junction
Polarity	Color band denotes positive end (cathode) except Bidirectional.
Terminal	Matte Tin-plated leads, Solderable per JESD22-B102D

Environmental Specifications

Temperature Cycle	JESD22-A104
Pressure Cooker	JESD 22-A102
High Temp. Storage	JESD22-A103
HTRB	JESD22-A108
Thermal Shock	JESD22-A106

Dimensions

DO-214AB (SMC J-Bend)

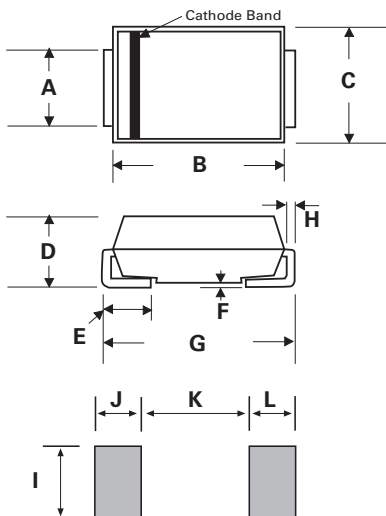

Dimensions	Inches		Millimeters	
	Min	Max	Min	Max
A	0.114	0.126	2.900	3.200
B	0.260	0.280	6.600	7.110
C	0.220	0.245	5.590	6.220
D	0.079	0.103	2.060	2.620
E	0.030	0.060	0.760	1.520
F	-	0.008	-	0.203
G	0.305	0.320	7.750	8.130
H	0.006	0.012	0.152	0.305
I	0.129	-	3.300	-
J	0.094	-	2.400	-
K	-	0.165	-	4.200
L	0.094	-	2.400	-

Part Numbering System

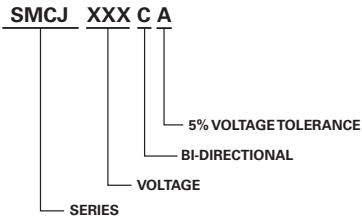

Part Marking System

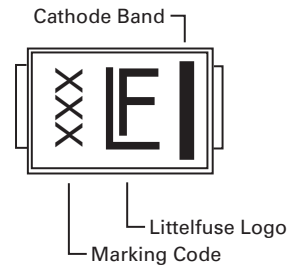

Packaging

Part number	Component Package	Quantity	Packaging Option	Packaging Specification
SMCJxxxXX	DO-214AB	3000	Tape & Reel – 16mm/13" tape	EIA STD RS-481

RoHS 1.5SMC Series



Agency Approvals

AGENCY	AGENCY FILE NUMBER
	E230531

Maximum Ratings and Thermal Characteristics (T_A=25°C unless otherwise noted)

Parameter	Symbol	Value	Unit
Peak Pulse Power Dissipation at T _A =25°C by 10x1000µs waveform (Fig.1)(Note 1), (Note 2)	P _{PPM}	1500	W
Power Dissipation on infinite heat sink at T _A =50°C	P _{MAV}	6.5	W
Peak Forward Surge Current, 8.3ms Single Half Sine Wave (Note 3)	I _{FSM}	200	A
Maximum Instantaneous Forward Voltage at 100A for Unidirectional only (Note 4)	V _F	3.5/5.0	V
Operating Junction and Storage Temperature Range	T _J , T _{STG}	-65 to 150	°C
Typical Thermal Resistance Junction to Lead	R _{θJL}	15	°C/W
Typical Thermal Resistance Junction to Ambient	R _{θJA}	75	°C/W

Notes:

1. Non-repetitive current pulse, per Fig. 3 and derated above T_A = 25°C per Fig. 2.
2. Mounted on copper pad area of 0.31x0.31" (8.0 x 8.0mm) to each terminal.
3. Measured on 8.3ms single half sine wave or equivalent square wave for unidirectional device only, duty cycle=4 per minute maximum.
4. V_F<3.5V for V_{BR} ≤ 200V and V_F<5.0V for V_{BR} ≥ 201V.

Description

The 1.5SMC series is designed specifically to protect sensitive electronic equipment from voltage transients induced by lightning and other transient voltage events.

Features

- RoHS compliant
- For surface mounted applications to optimize board space
- Low profile package.
- Built-in strain relief
- Typical maximum temperature coefficient $\Delta V_{BR} = 0.1\% \times V_{BR} @25^\circ\text{C}$
- Glass passivated chip junction
- 1500W peak pulse power capability at 10x1000µs waveform, repetition rate (duty cycles):0.01%
- Fast response time: typically less than 1.0ps from 0V to BV min
- Excellent clamping capability
- Low incremental surge resistance
- Typical I_R less than 1µA above 13V
- High Temperature soldering guaranteed: 260°C/40 seconds at terminals
- Plastic package has Underwriters Laboratory Flammability 94V-O
- Matte Tin Lead-free Plated

Applications

TVS devices are ideal for the protection of I/O Interfaces, V_{CC} bus and other vulnerable circuits used in Telecom, Computer, Industrial and Consumer electronic applications.

Electrical Characteristics

Part Number (Uni)	Part Number (Bi)	Marking		Reverse Stand off Voltage V_R (Volts)	Breakdown Voltage V_{BR} (Volts) @ I_T		Test Current I_T (mA)	Maximum Clamping Voltage V_C @ I_{PP} (V)	Maximum Peak Pulse Current I_{PP} (A)	Maximum Reverse Leakage I_R @ V_R (μ A)	Agency Approval 
		UNI	BI		MIN	MAX					
1.5SMC6.8A	1.5SMC6.8CA	6V8A	6V8C	5.80	6.45	7.14	10	10.5	144.8	1000	X
1.5SMC7.5A	1.5SMC7.5CA	7V5A	7V5C	6.40	7.13	7.88	10	11.3	134.5	500	X
1.5SMC8.2A	1.5SMC8.2CA	8V2A	8V2C	7.02	7.79	8.61	10	12.1	125.6	200	X
1.5SMC9.1A	1.5SMC9.1CA	9V1A	9V1C	7.78	8.65	9.50	1	13.4	113.4	50	X
1.5SMC10A	1.5SMC10CA	10A	10C	8.55	9.50	10.50	1	14.5	104.8	10	X
1.5SMC11A	1.5SMC11CA	11A	11C	9.40	10.50	11.60	1	15.6	97.4	5	X
1.5SMC12A	1.5SMC12CA	12A	12C	10.20	11.40	12.60	1	16.7	91.0	5	X
1.5SMC13A	1.5SMC13CA	13A	13C	11.10	12.40	13.70	1	18.2	83.5	1	X
1.5SMC15A	1.5SMC15CA	15A	15C	12.80	14.30	15.80	1	21.2	71.7	1	X
1.5SMC16A	1.5SMC16CA	16A	16C	13.60	15.20	16.80	1	22.5	67.6	1	X
1.5SMC18A	1.5SMC18CA	18A	18C	15.30	17.10	18.90	1	25.2	60.3	1	X
1.5SMC20A	1.5SMC20CA	20A	20C	17.10	19.00	21.00	1	27.7	54.9	1	X
1.5SMC22A	1.5SMC22CA	22A	22C	18.80	20.90	23.10	1	30.6	49.7	1	X
1.5SMC24A	1.5SMC24CA	24A	24C	20.50	22.80	25.20	1	33.2	45.8	1	X
1.5SMC27A	1.5SMC27CA	27A	27C	23.10	25.70	28.40	1	37.5	40.5	1	X
1.5SMC30A	1.5SMC30CA	30A	30C	25.60	28.50	31.50	1	41.4	36.7	1	X
1.5SMC33A	1.5SMC33CA	33A	33C	28.20	31.40	34.70	1	45.7	33.3	1	X
1.5SMC36A	1.5SMC36CA	36A	36C	30.80	34.20	37.80	1	49.9	30.5	1	X
1.5SMC39A	1.5SMC39CA	39A	39C	33.30	37.10	41.00	1	53.9	28.2	1	X
1.5SMC43A	1.5SMC43CA	43A	43C	36.80	40.90	45.20	1	59.3	25.6	1	X
1.5SMC47A	1.5SMC47CA	47A	47C	40.20	44.70	49.40	1	64.8	23.5	1	X
1.5SMC51A	1.5SMC51CA	51A	51C	43.60	48.50	53.60	1	70.1	21.7	1	X
1.5SMC56A	1.5SMC56CA	56A	56C	47.80	53.20	58.80	1	77.0	19.7	1	X
1.5SMC62A	1.5SMC62CA	62A	62C	53.00	58.90	65.10	1	85.0	17.9	1	X
1.5SMC68A	1.5SMC68CA	68A	68C	58.10	64.60	71.40	1	92.0	16.5	1	X
1.5SMC75A	1.5SMC75CA	75A	75C	64.10	71.30	78.80	1	103.0	14.8	1	X
1.5SMC82A	1.5SMC82CA	82A	82C	70.10	77.90	86.10	1	113.0	13.5	1	X
1.5SMC91A	1.5SMC91CA	91A	91C	77.80	86.50	95.50	1	125.0	12.2	1	X
1.5SMC100A	1.5SMC100CA	68A	100C	85.50	95.00	105.00	1	137.0	11.1	1	X
1.5SMC110A	1.5SMC110CA	75A	110C	94.00	105.00	116.00	1	152.0	10.0	1	X
1.5SMC120A	1.5SMC120CA	120A	120C	102.00	114.00	126.00	1	165.0	9.2	1	X
1.5SMC130A	1.5SMC130CA	130A	130C	111.00	124.00	137.00	1	179.0	8.5	1	X
1.5SMC150A	1.5SMC150CA	150A	150C	128.00	143.00	158.00	1	207.0	7.3	1	X
1.5SMC160A	1.5SMC160CA	160A	160C	136.00	152.00	168.00	1	219.0	6.9	1	X
1.5SMC170A	1.5SMC170CA	170A	170C	145.00	162.00	179.00	1	234.0	6.5	1	X
1.5SMC180A	1.5SMC180CA	180A	180C	154.00	171.00	189.00	1	246.0	6.2	1	X
1.5SMC200A	1.5SMC200CA	200A	200C	171.00	190.00	210.00	1	274.0	5.5	1	X
1.5SMC220A	1.5SMC220CA	220A	220C	185.00	209.00	231.00	1	328.0	4.6	1	X
1.5SMC250A	1.5SMC250CA	250A	250C	214.00	237.00	263.00	1	344.0	4.4	1	X
1.5SMC300A	1.5SMC300CA	300A	300C	256.00	285.00	315.00	1	414.0	3.7	1	X
1.5SMC350A	1.5SMC350CA	350A	350C	300.00	332.00	368.00	1	482.0	3.2	1	X
1.5SMC400A	1.5SMC400CA	400A	400C	342.00	380.00	420.00	1	548.0	2.8	1	X
1.5SMC440A	1.5SMC440CA	440A	440C	376.00	418.00	462.00	1	602.0	2.5	1	X
1.5SMC480A	1.5SMC480CA	480A	480C	408.00	456.00	504.00	1	658.0	2.3	1	X
1.5SMC510A	1.5SMC510CA	510A	510C	434.00	485.00	535.00	1	698.0	2.1	1	X
1.5SMC530A	1.5SMC530CA	530A	530C	477.00	503.50	556.50	1	725.0	2.1	1	X
1.5SMC540A	1.5SMC540CA	540A	540C	486.00	513.00	567.00	1	740.0	2.0	1	X
1.5SMC550A	1.5SMC550CA	550A	550C	495.00	522.50	577.50	1	760.0	2.0	1	X

For bidirectional type having V_R of 10 volts and less, the I_R limit is double.

The available parts are "A" type only, the parts without A (V_{BR} is $\pm 10\%$) is not available.

Ratings and Characteristic Curves ($T_A=25^\circ\text{C}$ unless otherwise noted)

Figure 1 - Peak Pulse Power Rating

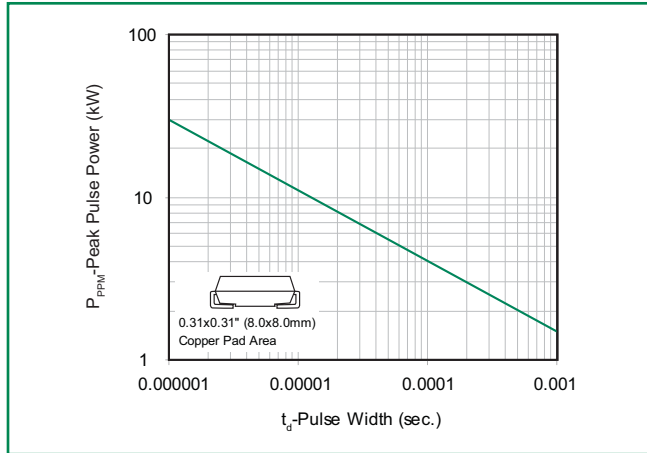

Figure 2 - Pulse Derating Curve

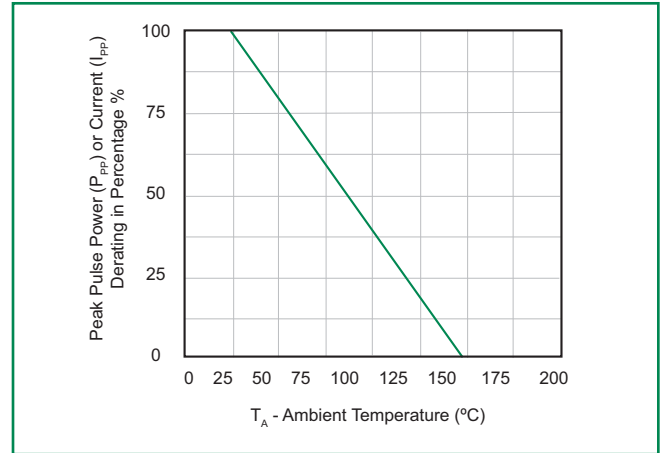

Figure 3 - Pulse Waveform

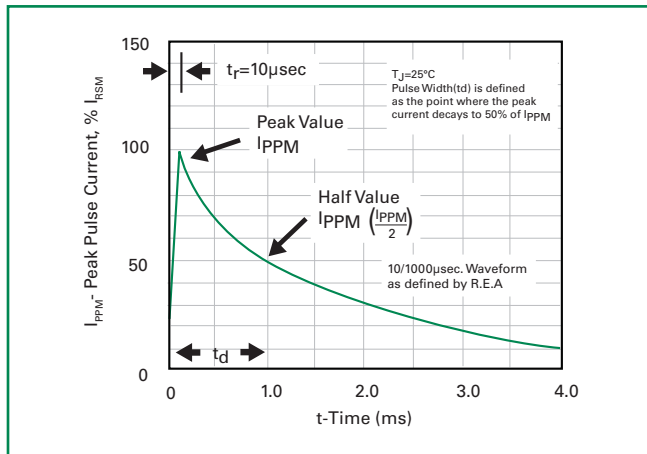

Figure 4 - Typical Junction Capacitance

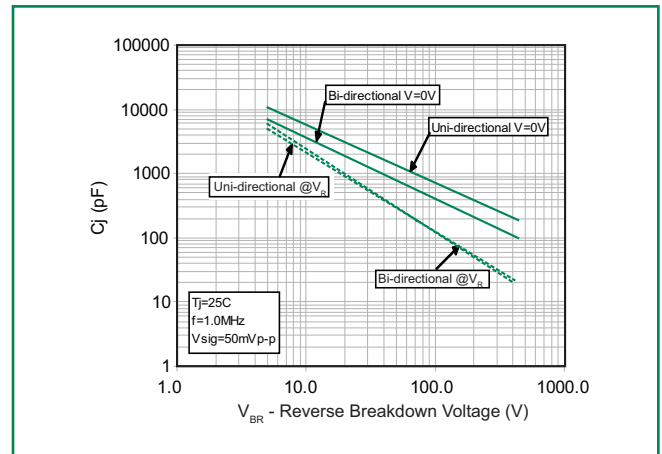

Figure 5 - Steady State Power Dissipation Derating Curve

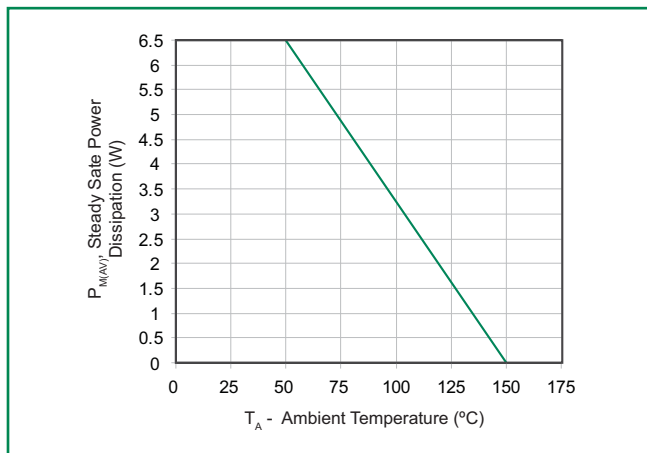
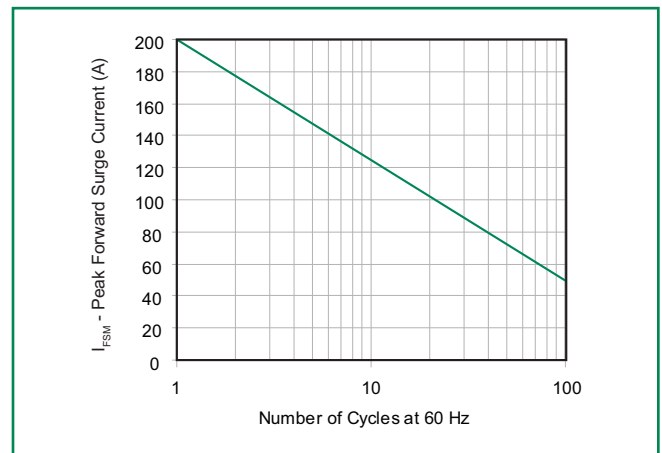
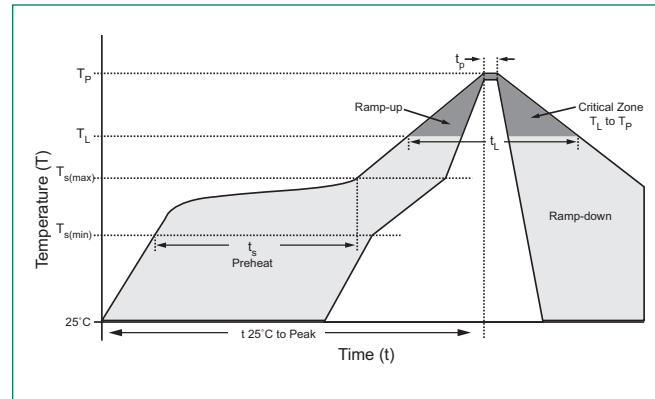

Figure 6 - Maximum Non-Repetitive Peak Forward Surge Current Uni-Directional Only



Soldering Parameters

Reflow Condition		Lead-free assembly
Pre Heat	- Temperature Min ($T_{s(min)}$)	150°C
	- Temperature Max ($T_{s(max)}$)	200°C
	- Time (min to max) (t_s)	60 – 180 secs
Average ramp up rate (Liquidus Temp (T_L) to peak)		3°C/second max
$T_{s(max)}$ to T_L - Ramp-up Rate		3°C/second max
Reflow	- Temperature (T_L) (Liquidus)	217°C
	- Time (min to max) (t_s)	60 – 150 seconds
Peak Temperature (T_p)		260 ^{+0/-5} °C
Time within 5°C of actual peak Temperature (t_p)		20 – 40 seconds
Ramp-down Rate		6°C/second max
Time 25°C to peak Temperature (T_p)		8 minutes Max.
Do not exceed		280°C



Physical Specifications

Weight	0.007 ounce, 0.21 grams
Case	JEDEC DO214AB. Molded plastic body over glass passivated junction
Polarity	Color band denotes positive end (cathode) except Bidirectional.
Terminal	Matte Tin-plated leads, Solderable per JESD22-B102D

Environmental Specifications

Temperature Cycle	JESD22-A104
Pressure Cooker	JESD 22-A102
High Temp. Storage	JESD22-A103
HTRB	JESD22-A108
Thermal Shock	JESD22-A106

Dimensions

DO-214AB (SMC J-Bend)

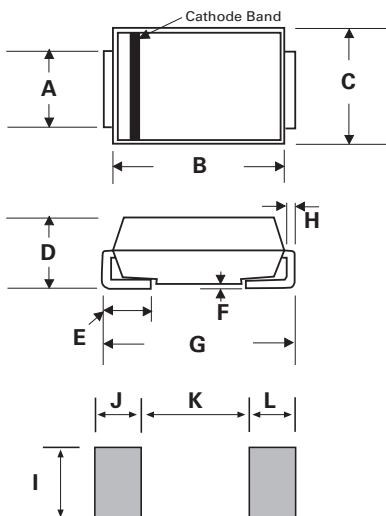

Dimensions	Inches		Millimeters	
	Min	Max	Min	Max
A	0.114	0.126	2.900	3.200
B	0.260	0.280	6.600	7.110
C	0.220	0.245	5.590	6.220
D	0.079	0.103	2.060	2.620
E	0.030	0.060	0.760	1.520
F	-	0.008	-	0.203
G	0.305	0.320	7.750	8.130
H	0.006	0.012	0.152	0.305
I	0.129	-	3.300	-
J	0.094	-	2.400	-
K	-	0.165	-	4.200
L	0.094	-	2.400	-

Part Numbering System

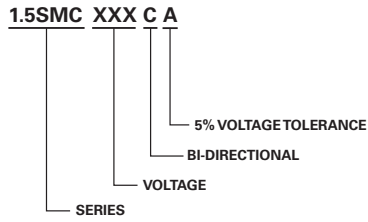

Part Marking System

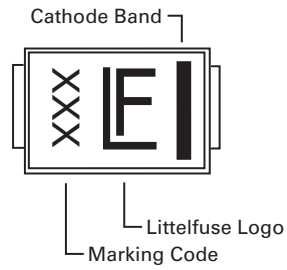

Packaging

Part number	Component Package	Quantity	Packaging Option	Packaging Specification
1.5SMCxxxXX	DO-214AB	3000	Tape & Reel – 16mm/13" tape	EIA STD RS-481

RoHS SMDJ Series

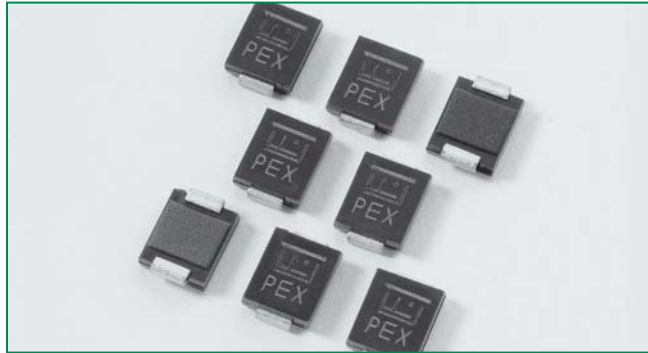

Agency Approvals

AGENCY	AGENCY FILE NUMBER
	E230531

Maximum Ratings and Thermal Characteristics (T_A=25°C unless otherwise noted)

Parameter	Symbol	Value	Unit
Peak Pulse Power Dissipation at T _A =25°C by 10x1000µs waveform (Fig.1)(Note 1), (Note 2)	P _{PPM}	3000	W
Power Dissipation on infinite heat sink at T _A =50°C	P _{M(AV)}	6.5	W
Peak Forward Surge Current, 8.3ms Single Half Sine Wave (Note 3)	I _{FSM}	300	A
Maximum Instantaneous Forward Voltage at 100A for Unidirectional only	V _F	3.5	V
Operating Junction and Storage Temperature Range	T _J , T _{STG}	-65 to 150	°C
Typical Thermal Resistance Junction to Lead	R _{θJL}	15	°C/W
Typical Thermal Resistance Junction to Ambient	R _{θJA}	75	°C/W

Notes:

1. Non-repetitive current pulse, per Fig. 3 and derated above T_A = 25°C per Fig. 2.
2. Mounted on copper pad area of 0.31x0.31" (8.0 x 8.0mm) to each terminal.
3. Measured on 8.3ms single half sine wave or equivalent square wave for unidirectional device only, duty cycle=4 per minute maximum.

Description

The SMDJ series is designed specifically to protect sensitive electronic equipment from voltage transients induced by lightning and other transient voltage events.

Features

- RoHS compliant
- For surface mounted applications in order to optimize board space
- Low profile package
- Built-in strain relief
- Typical maximum temperature coefficient $\Delta V_{BR} = 0.1\% \times V_{BR} @ 25^\circ\text{C}$
- Glass passivated chip junction
- 3000W peak pulse power capability at 10x1000µs waveform, repetition rate (duty cycles):0.01%
- Fast response time: typically less than 1.0ps from 0V to BV min
- Excellent clamping capability
- Low incremental surge resistance
- Typical I_R less than 2µA above 12V
- High Temperature soldering guaranteed: 260°C/40 seconds at terminals
- Plastic package has Underwriters Laboratory Flammability 94V-0
- Matte Tin Lead-free Plated

Applications

TVS devices are ideal for the protection of I/O Interfaces, V_{CC} bus and other vulnerable circuits used in Telecom, Computer, Industrial and Consumer electronic applications.

Electrical Characteristics

Part Number (Uni)	Part Number (Bi)	Marking		Reverse Stand off Voltage V_R (Volts)	Breakdown Voltage V_{BR} (Volts) @ I_T		Test Current I_T (mA)	Maximum Clamping Voltage V_C @ I_{PP} (V)	Maximum Peak Pulse Current I_{PP} (A)	Maximum Reverse Leakage I_R @ V_R (μ A)	Agency Approval 
		UNI	BI		MIN	MAX					
SMDJ5.0A	SMDJ5.0CA	RDE	DDE	5.0	6.40	7.00	10	9.2	326.1	800	X
SMDJ6.0A	SMDJ6.0CA	RDG	DDG	6.0	6.67	7.37	10	10.3	291.3	800	X
SMDJ6.5A	SMDJ6.5CA	RDK	DDK	6.5	7.22	7.98	10	11.2	267.9	500	X
SMDJ7.0A	SMDJ7.0CA	PDM	DDM	7.0	7.78	8.60	10	12.0	250.0	200	X
SMDJ7.5A	SMDJ7.5CA	PDP	DDP	7.5	8.33	9.21	1	12.9	232.6	100	X
SMDJ8.0A	SMDJ8.0CA	PDR	DDR	8.0	8.89	9.83	1	13.6	220.6	50	X
SMDJ8.5A	SMDJ8.5CA	PDT	DDT	8.5	9.44	10.40	1	14.4	208.3	20	X
SMDJ9.0A	SMDJ9.0CA	PDV	DDV	9.0	10.00	11.10	1	15.4	194.8	10	X
SMDJ10A	SMDJ10CA	PDX	DDX	10.0	11.10	12.30	1	17.0	176.5	5	X
SMDJ11A	SMDJ11CA	PDZ	DDZ	11.0	12.20	13.50	1	18.2	164.8	2	X
SMDJ12A	SMDJ12CA	PEE	DEE	12.0	13.30	14.70	1	19.9	150.8	2	X
SMDJ13A	SMDJ13CA	PEG	DEG	13.0	14.40	15.90	1	21.5	139.5	2	X
SMDJ14A	SMDJ14CA	PEK	DEK	14.0	15.60	17.20	1	23.2	129.3	2	X
SMDJ15A	SMDJ15CA	PEM	DEM	15.0	16.70	18.50	1	24.4	123.0	2	X
SMDJ16A	SMDJ16CA	PEP	DEP	16.0	17.80	19.70	1	26.0	115.4	2	X
SMDJ17A	SMDJ17CA	PER	DER	17.0	18.90	20.90	1	27.6	108.7	2	X
SMDJ18A	SMDJ18CA	PET	DET	18.0	20.00	22.10	1	29.2	102.7	2	X
SMDJ20A	SMDJ20CA	PEV	DEV	20.0	22.20	24.50	1	32.4	92.6	2	X
SMDJ22A	SMDJ22CA	PEX	DEX	22.0	24.40	26.90	1	35.5	84.5	2	X
SMDJ24A	SMDJ24CA	PEZ	DEZ	24.0	26.70	29.50	1	38.9	77.1	2	X
SMDJ26A	SMDJ26CA	PFE	DFE	26.0	28.90	31.90	1	42.1	71.3	2	X
SMDJ28A	SMDJ28CA	PFG	DFG	28.0	31.10	34.40	1	45.4	66.1	2	X
SMDJ30A	SMDJ30CA	PFK	DFK	30.0	33.30	36.80	1	48.4	62.0	2	X
SMDJ33A	SMDJ33CA	PFM	DFM	33.0	36.70	40.60	1	53.3	56.3	2	X
SMDJ36A	SMDJ36CA	PFP	DFP	36.0	40.00	44.20	1	58.1	51.6	2	X
SMDJ40A	SMDJ40CA	PFR	DFR	40.0	44.40	49.10	1	64.5	46.5	2	X
SMDJ43A	SMDJ43CA	PFT	DFT	43.0	47.80	52.80	1	69.4	43.2	2	X
SMDJ45A	SMDJ45CA	PFV	DFV	45.0	50.00	55.30	1	72.7	41.3	2	X
SMDJ48A	SMDJ48CA	PFX	DFX	48.0	53.30	58.90	1	77.4	38.8	2	X
SMDJ51A	SMDJ51CA	PFZ	DFZ	51.0	56.70	62.70	1	82.4	36.4	2	X
SMDJ54A	SMDJ54CA	RGE	DGE	54.0	60.00	66.30	1	87.1	34.4	2	X
SMDJ58A	SMDJ58CA	PGG	DGG	58.0	64.40	71.20	1	93.6	32.1	2	X
SMDJ60A	SMDJ60CA	PGK	DGK	60.0	66.70	73.70	1	96.8	31.0	2	X
SMDJ64A	SMDJ64CA	PGM	DGM	64.0	71.10	78.60	1	103.0	29.1	2	X
SMDJ70A	SMDJ70CA	PGP	DGP	70.0	77.80	86.00	1	113.0	26.5	2	X
SMDJ75A	SMDJ75CA	PGR	DGR	75.0	83.30	92.10	1	121.0	24.8	2	X
SMDJ78A	SMDJ78CA	PGT	DGT	78.0	86.70	95.80	1	126.0	23.8	2	X
SMDJ85A	SMDJ85CA	PGV	DGV	85.0	94.40	104.00	1	137.0	21.9	2	X
SMDJ90A	SMDJ90CA	PGX	DGX	90.0	100.00	111.00	1	146.0	20.5	2	X
SMDJ100A	SMDJ100CA	PGZ	DGZ	100.0	111.00	123.00	1	162.0	18.5	2	X
SMDJ110A	SMDJ110CA	PHE	DHE	110.0	122.00	135.00	1	177.0	16.9	2	X
SMDJ120A	SMDJ120CA	PHG	DHG	120.0	133.00	147.00	1	193.0	15.5	2	X
SMDJ130A	SMDJ130CA	PHK	DHK	130.0	144.00	159.00	1	209.0	14.4	2	X
SMDJ150A	SMDJ150CA	PHM	DHM	150.0	167.00	185.00	1	243.0	12.3	2	X
SMDJ160A	SMDJ160CA	PHP	DHP	160.0	178.00	197.00	1	259.0	11.6	2	X
SMDJ170A	SMDJ170CA	PHR	DHR	170.0	189.00	209.00	1	275.0	10.9	2	X

For parts without A, the V_{BR} is $\pm 10\%$, and V_C is 5% higher than A parts.

For bidirectional type having V_R of 10 volts and less, the I_R limit is double.

Ratings and Characteristic Curves ($T_A=25^\circ\text{C}$ unless otherwise noted)

Figure 1 - Peak Pulse Power Rating Curve

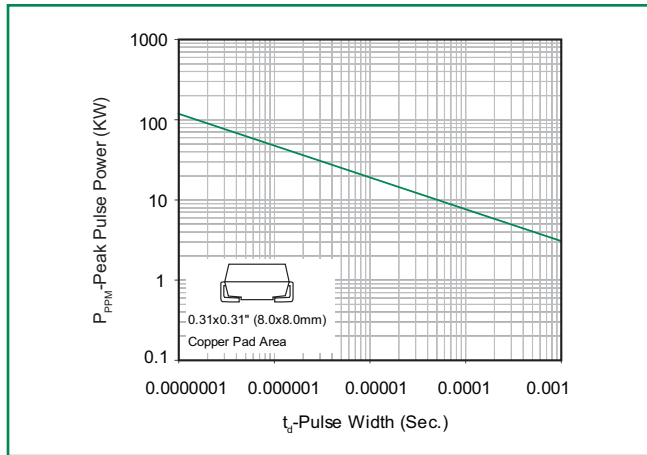

Figure 2 - Pulse Derating Curve

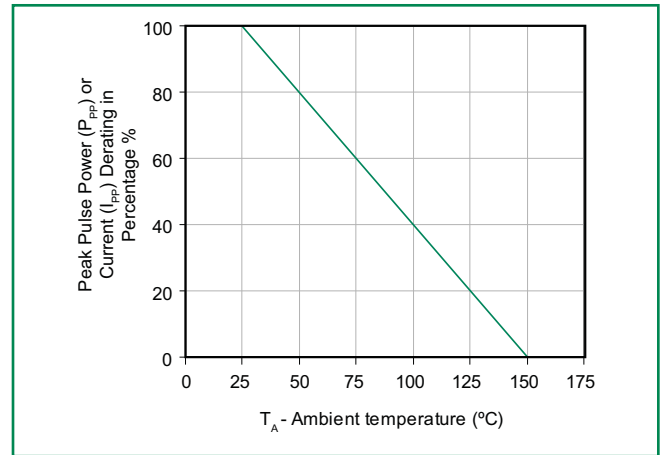

Figure 3 - Pulse Waveform

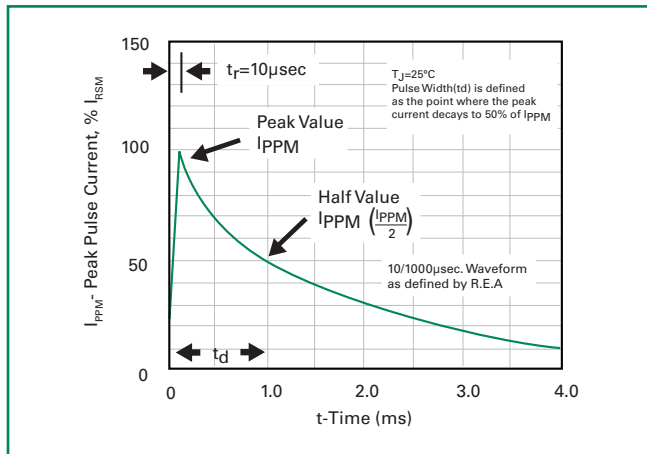

Figure 4 - Typical Junction Capacitance

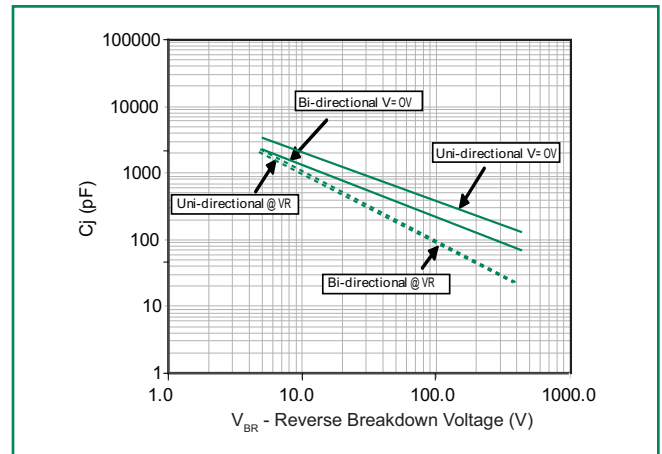

Figure 5 - Steady State Power Derating Curve

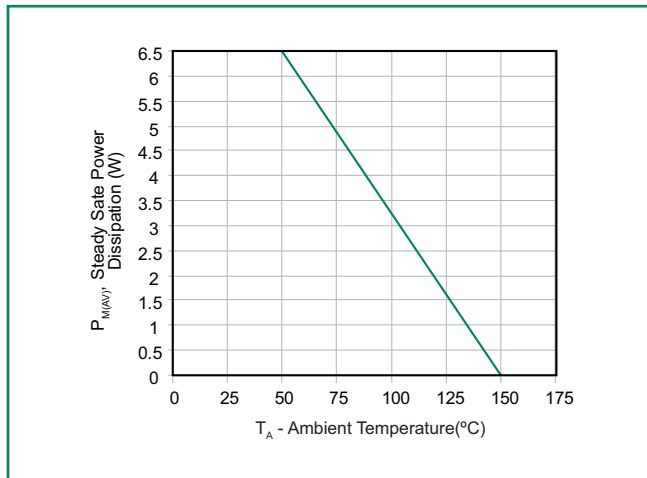
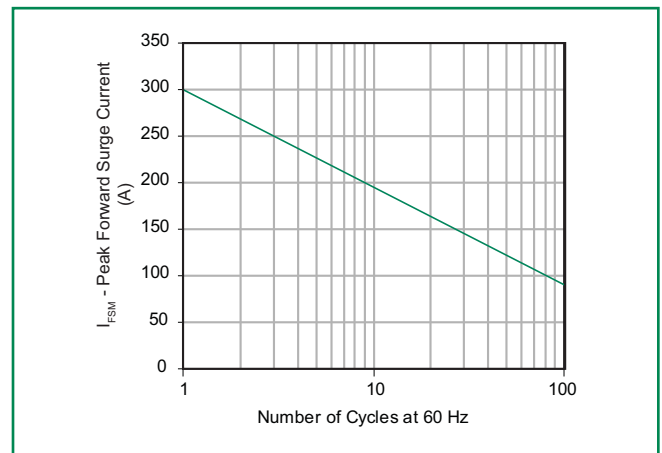
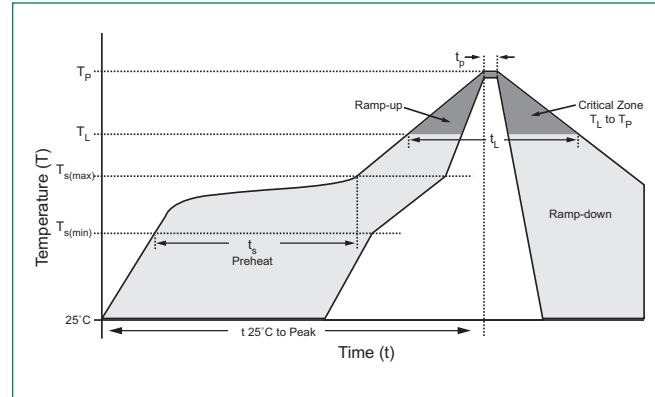

Figure 6 - Maximum Non-Repetitive Peak Forward Surge Current Uni-Directional only



Soldering Parameters

Reflow Condition		Lead-free assembly
Pre Heat	- Temperature Min ($T_{s(min)}$)	150°C
	- Temperature Max ($T_{s(max)}$)	200°C
	- Time (min to max) (t_s)	60 – 180 secs
Average ramp up rate (Liquidus Temp (T_L) to peak)		3°C/second max
$T_{s(max)}$ to T_L - Ramp-up Rate		3°C/second max
Reflow	- Temperature (T_L) (Liquidus)	217°C
	- Time (min to max) (t_s)	60 – 150 seconds
Peak Temperature (T_p)		260 ^{+0/-5} °C
Time within 5°C of actual peak Temperature (t_p)		20 – 40 seconds
Ramp-down Rate		6°C/second max
Time 25°C to peak Temperature (T_p)		8 minutes Max.
Do not exceed		280°C



Physical Specifications

Weight	0.007 ounce, 0.21 grams
Case	JEDEC DO214AB. Molded plastic body over glass passivated junction
Polarity	Color band denotes positive end (cathode) except Bidirectional.
Terminal	Matte Tin-plated leads, Solderable per JESD22-B102D

Environmental Specifications

Temperature Cycle	JESD22-A104
Pressure Cooker	JESD 22-A102
High Temp. Storage	JESD22-A103
HTRB	JESD22-A108
Thermal Shock	JESD22-A106

Dimensions

DO-214AB (SMC J-Bend)

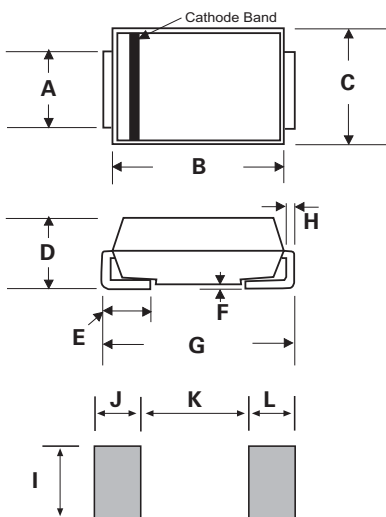

Dimensions	Inches		Millimeters	
	Min	Max	Min	Max
A	0.114	0.126	2.900	3.200
B	0.260	0.280	6.600	7.110
C	0.220	0.245	5.590	6.220
D	0.079	0.103	2.060	2.620
E	0.030	0.060	0.760	1.520
F	-	0.008	-	0.203
G	0.305	0.320	7.750	8.130
H	0.006	0.012	0.152	0.305
I	0.129	-	3.300	-
J	0.094	-	2.400	-
K	-	0.165	-	4.200
L	0.094	-	2.400	-

Part Numbering System

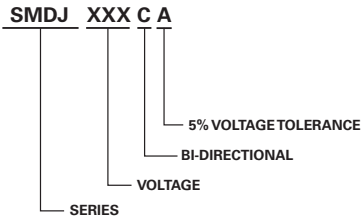

Part Marking System

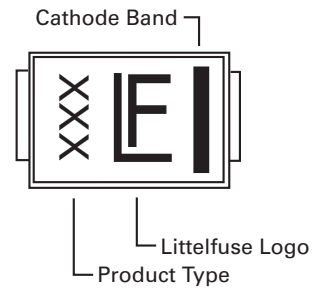

Packaging

Part number	Component Package	Quantity	Packaging Option	Packaging Specification
SMDJxxxXX	DO-214AB	3000	Tape & Reel – 16mm/13" tape	EIA STD RS-481

RoHS 5.0SMDJ Series



Agency Approvals

AGENCY	AGENCY FILE NUMBER
	E230531

**Maximum Ratings and Thermal Characteristics
(T_A=25°C unless otherwise noted)**

Parameter	Symbol	Value	Unit
Peak Pulse Power Dissipation at T _A =25°C by 10x1000µs waveform (Fig.1)(Note 1), (Note 2)	P _{PPM}	5000	W
Power Dissipation on infinite heat sink at T _A =50°C	P _{M(AV)}	6.5	W
Peak Forward Surge Current, 8.3ms Single Half Sine Wave (Note 3)	I _{FSM}	300	A
Maximum Instantaneous Forward Voltage at 100A for Unidirectional only	V _F	5.0	V
Operating Junction and Storage Temperature Range	T _J , T _{STG}	-65 to 150	°C
Typical Thermal Resistance Junction to Lead	R _{θJL}	15	°C/W
Typical Thermal Resistance Junction to Ambient	R _{θJA}	75	°C/W

Notes:

1. Non-repetitive current pulse, per Fig. 3 and derated above T_A = 25°C per Fig. 2.
2. Mounted on copper pad area of 0.31x0.31" (8.0 x 8.0mm) to each terminal.
3. Measured on 8.3ms single half sine wave or equivalent square wave for unidirectional device only, duty cycle=4 per minute maximum.

Description

The 5.0SMDJ series is designed specifically to protect sensitive electronic equipment from voltage transients induced by lightning and other transient voltage events.

Features

- RoHS compliant
- For surface mounted applications to optimize board space
- Low profile package
- Built-in strain relief
- Typical maximum temperature coefficient $\Delta V_{BR} = 0.1\% \times V_{BR} @25^\circ\text{C}$
- Glass passivated chip junction
- 5000W peak pulse power capability at 10x1000µs waveform, repetition rate (duty cycles):0.01%
- Fast response time: typically less than 1.0ps from 0V to BV min
- Excellent clamping capability
- Low incremental surge resistance
- Typical I_R less than 5µA above 22V
- High Temperature soldering guaranteed: 260°C/40 seconds at terminals
- Plastic package has Underwriters Laboratory Flammability 94V-0
- Matte Tin Lead-free Plated

Applications

TVS devices are ideal for the protection of I/O Interfaces, V_{CC} bus and other vulnerable circuits used in Telecom, Computer, Industrial and Consumer electronic applications.

Electrical Characteristics

Part Number (Uni)	Part Number (Bi)	Marking		Reverse Stand off Voltage V_R (Volts)	Breakdown Voltage V_{BR} (Volts) @ I_T		Test Current I_T (mA)	Maximum Clamping Voltage V_C @ I_{PP} (V)	Maximum Peak Pulse Current I_{PP} (A)	Maximum Reverse Leakage I_R @ V_R (μ A)	Agency Approval 
		UNI	BI		MIN	MAX					
5.0SMDJ12A	5.0SMDJ12CA	5PEP	5BEP	12.0	13.30	14.70	10	19.9	252.00	800	
5.0SMDJ13A	5.0SMDJ13CA	5PEQ	5BEQ	13.0	14.40	15.90	10	21.5	233.00	500	
5.0SMDJ14A	5.0SMDJ14CA	5PER	5BER	14.0	15.60	17.20	10	23.2	216.00	200	
5.0SMDJ15A	5.0SMDJ15CA	5PES	5BES	15.0	16.70	18.50	1	24.4	205.00	100	
5.0SMDJ16A	5.0SMDJ16CA	5PET	5BET	16.0	17.80	19.70	1	26.0	193.00	50	
5.0SMDJ17A	5.0SMDJ17CA	5PEU	5BEU	17.0	18.90	20.90	1	27.6	181.00	20	
5.0SMDJ18A	5.0SMDJ18CA	5PEV	5BEV	18.0	20.00	22.10	1	29.2	172.00	10	
5.0SMDJ20A	5.0SMDJ20CA	5PEW	5BEW	20.0	22.20	24.50	1	32.4	155.00	5	X
5.0SMDJ22A	5.0SMDJ22CA	5PEX	5BEX	22.0	24.40	26.90	1	35.5	141.00	5	X
5.0SMDJ24A	5.0SMDJ24CA	5PEZ	5BEZ	24.0	26.70	29.50	1	38.9	129.00	5	X
5.0SMDJ26A	5.0SMDJ26CA	5PFE	5BFE	26.0	28.90	31.90	1	42.1	119.00	5	X
5.0SMDJ28A	5.0SMDJ28CA	5PFG	5BFG	28.0	31.10	34.40	1	45.4	110.00	5	X
5.0SMDJ30A	5.0SMDJ30CA	5PFK	5BFK	30.0	33.30	36.80	1	48.4	103.00	5	X
5.0SMDJ33A	5.0SMDJ33CA	5PFM	5BFM	33.0	36.70	40.60	1	53.3	93.90	5	X
5.0SMDJ36A	5.0SMDJ36CA	5PFP	5BFP	36.0	40.00	44.20	1	58.1	86.10	5	X
5.0SMDJ40A	5.0SMDJ40CA	5PFR	5BFR	40.0	44.40	49.10	1	64.5	77.60	5	X
5.0SMDJ43A	5.0SMDJ43CA	5PFT	5BFT	43.0	47.80	52.80	1	69.4	72.10	5	X
5.0SMDJ45A	5.0SMDJ45CA	5PFV	5BFV	45.0	50.00	55.30	1	72.7	68.80	5	X
5.0SMDJ48A	-	5PFX	-	48.0	53.30	58.90	1	77.4	64.70	5	X
5.0SMDJ51A	-	5PFZ	-	51.0	56.70	62.70	1	82.4	60.70	5	X
5.0SMDJ54A	-	5RGE	-	54.0	60.00	66.30	1	87.1	57.50	5	X
5.0SMDJ58A	-	5PGG	-	58.0	64.40	71.20	1	93.6	53.50	5	X
5.0SMDJ60A	-	5PGK	-	60.0	66.70	73.70	1	96.8	51.70	5	X
5.0SMDJ64A	-	5PGM	-	64.0	71.10	78.60	1	103.0	48.60	5	X
5.0SMDJ70A	-	5PGP	-	70.0	77.80	86.00	1	113.0	44.30	5	X
5.0SMDJ75A	-	5PGR	-	75.0	83.30	92.10	1	121.0	41.40	5	X
5.0SMDJ78A	-	5PGT	-	78.0	86.70	95.80	1	126.0	39.70	5	X
5.0SMDJ85A	-	5PGV	-	85.0	94.40	104.00	1	137.0	36.50	5	X
5.0SMDJ90A	-	5PGX	-	90.0	100.00	111.00	1	146.0	34.30	5	X
5.0SMDJ100A	-	5PGZ	-	100.0	111.00	123.00	1	162.0	30.90	5	X
5.0SMDJ110A	-	5PHE	-	110.0	122.00	135.00	1	177.0	28.30	5	X
5.0SMDJ120A	-	5PHG	-	120.0	133.00	147.00	1	193.0	26.00	5	X
5.0SMDJ130A	-	5PHK	-	130.0	144.00	159.00	1	209.0	24.00	5	X
5.0SMDJ150A	-	5PHM	-	150.0	167.00	185.00	1	243.0	20.60	5	X
5.0SMDJ160A	-	5PHP	-	160.0	178.00	197.00	1	259.0	19.30	5	X
5.0SMDJ170A	-	5PHR	-	170.0	189.00	209.00	1	275.0	18.20	5	X

For Bidirectional type having V_R of 20 volts and less, the I_R limit is double.

Ratings and Characteristic Curves ($T_A=25^\circ\text{C}$ unless otherwise noted)

Figure 1 - Peak Pulse Power Rating Curve

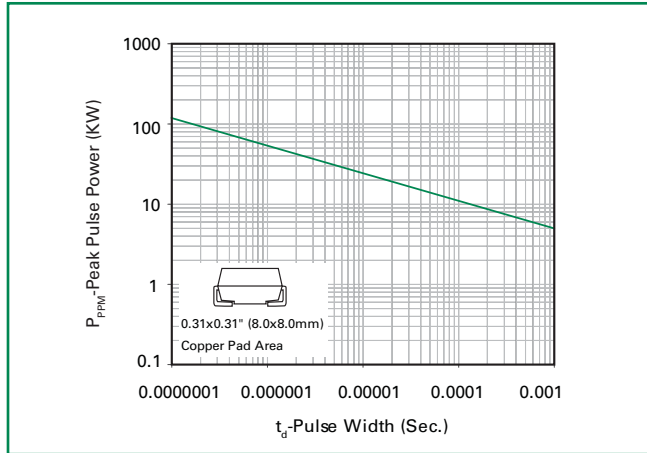

Figure 2 - Pulse Derating Curve

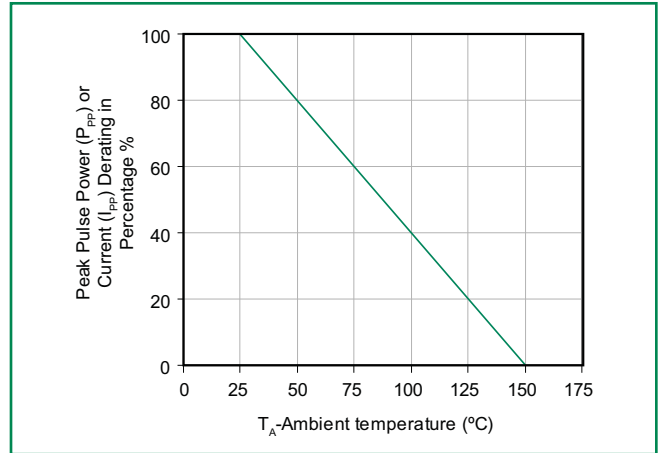

Figure 3 - Pulse Waveform

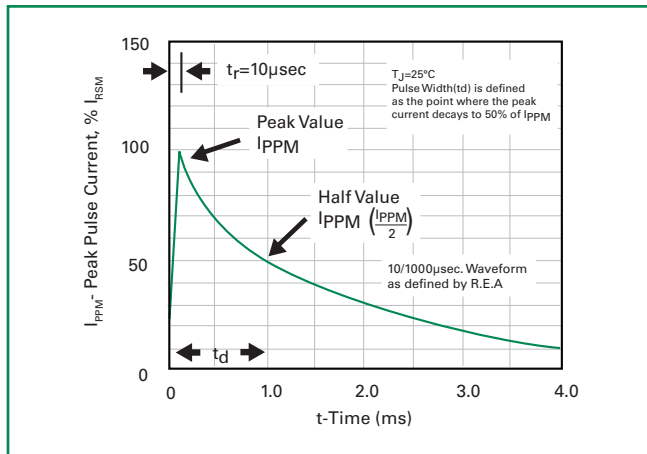

Figure 4 - Typical Junction Capacitance

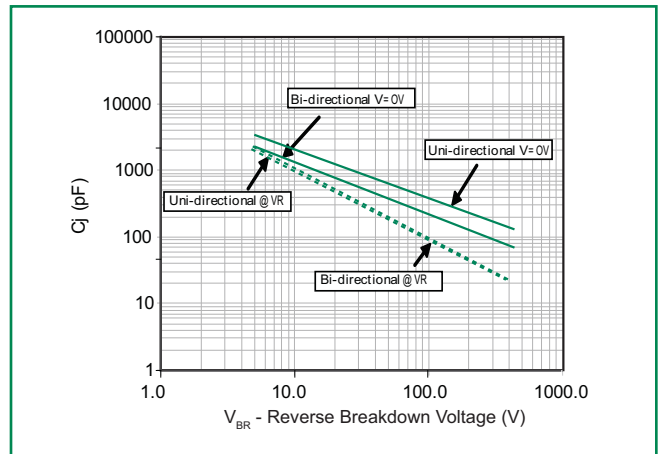

Figure 5 - Steady State Power Derating Curve

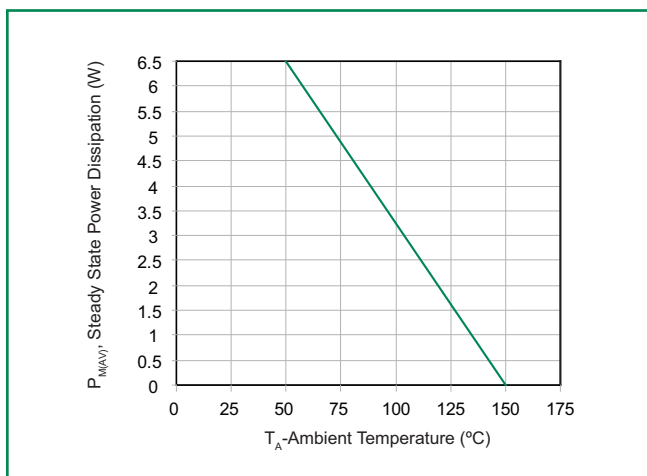
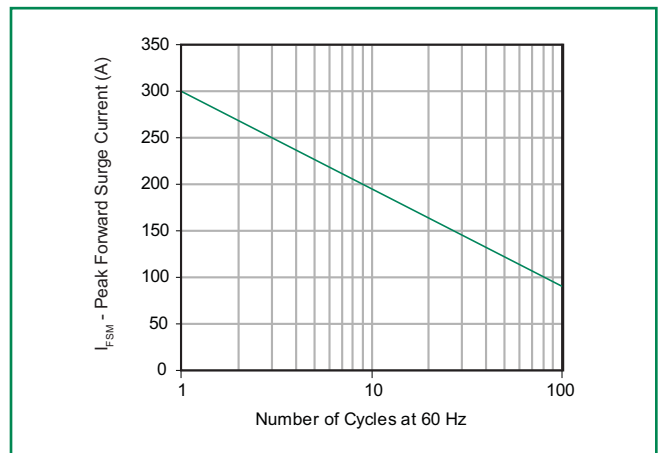
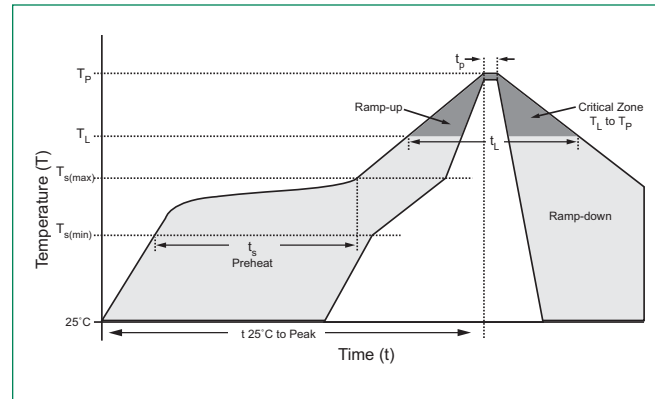

Figure 6 - Maximum Non-Repetitive Peak Forward Surge Current Uni-Directional Only



Soldering Parameters

Reflow Condition		Lead-free assembly
Pre Heat	- Temperature Min ($T_{s(min)}$)	150°C
	- Temperature Max ($T_{s(max)}$)	200°C
	- Time (min to max) (t_s)	60 – 180 secs
Average ramp up rate (Liquidus Temp (T_L) to peak)		3°C/second max
$T_{s(max)}$ to T_L - Ramp-up Rate		3°C/second max
Reflow	- Temperature (T_L) (Liquidus)	217°C
	- Time (min to max) (t_s)	60 – 150 seconds
Peak Temperature (T_p)		260 ^{+0/-5} °C
Time within 5°C of actual peak Temperature (t_p)		20 – 40 seconds
Ramp-down Rate		6°C/second max
Time 25°C to peak Temperature (T_p)		8 minutes Max.
Do not exceed		280°C



Physical Specifications

Weight	0.007 ounce, 0.21 grams
Case	JEDEC DO214AB. Molded plastic body over glass passivated junction
Polarity	Color band denotes positive end (cathode) except Bidirectional.
Terminal	Matte Tin-plated leads, Solderable per JESD22-B102D

Environmental Specifications

Temperature Cycle	JESD22-A104
Pressure Cooker	JESD 22-A102
High Temp. Storage	JESD22-A103
HTRB	JESD22-A108
Thermal Shock	JESD22-A106

Dimensions

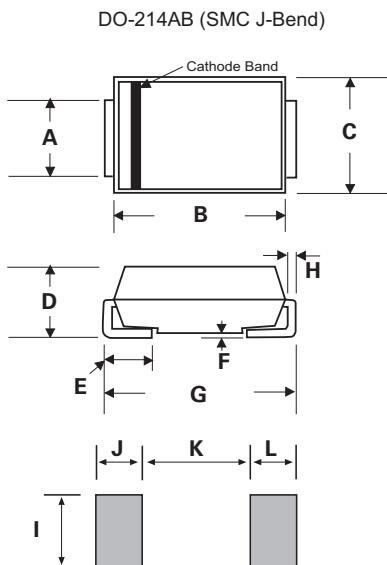

Dimensions	Inches		Millimeters	
	Min	Max	Min	Max
A	0.114	0.126	2.900	3.200
B	0.260	0.280	6.600	7.110
C	0.220	0.245	5.590	6.220
D	0.079	0.103	2.060	2.620
E	0.030	0.060	0.760	1.520
F	-	0.008	-	0.203
G	0.305	0.320	7.750	8.130
H	0.006	0.012	0.152	0.305
I	0.129	-	3.300	-
J	0.094	-	2.400	-
K	-	0.165	-	4.200
L	0.094	-	2.400	-

Part Numbering System

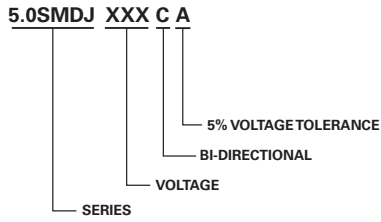

Part Marking System

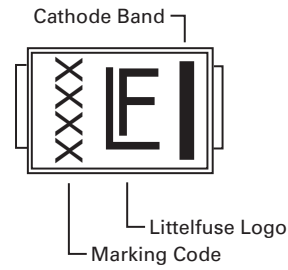

Packaging

Part number	Component Package	Quantity	Packaging Option	Packaging Specification
5.0SMDJxxxXX	DO-214AB	3000	Tape & Reel – 16mm/13" tape	EIA STD RS-481

RoHS P4KE Series



Agency Approvals

AGENCY	AGENCY FILE NUMBER
	E230531

**Maximum Ratings and Thermal Characteristics
(T_A=25°C unless otherwise noted)**

Parameter	Symbol	Value	Unit
Peak Pulse Power Dissipation by 10x1000µs test waveform (Fig.1) (Note 1)	P _{PPM}	400	W
Steady State Power Dissipation on infinite heat sink at T _L =75°C (Fig. 5)	P _D	1.5	W
Peak Forward Surge Current, 8.3ms Single Half Sine Wave Unidirectional only (Note 2)	I _{FSM}	40	A
Maximum Instantaneous Forward Voltage at 25A for Unidirectional only (Note 3)	V _F	3.5/5.0	V
Operating Junction and Storage Temperature Range	T _J , T _{STG}	-55 to 175	°C
Typical Thermal Resistance Junction to Lead	R _{θJL}	60	°C/W
Typical Thermal Resistance Junction to Ambient	R _{θJA}	100	°C/W

Notes:

1. Non-repetitive current pulse, per Fig. 3 and derated above T_A = 25°C per Fig. 2.
2. Measured on 8.3ms single half sine wave or equivalent square wave, duty cycle=4 per minute maximum.
3. V_F<3.5V for devices of V_{BR} ≤ 200V and V_F<5.0V for devices of V_{BR} ≥ 201V.

Description

The P4KE Series is designed specifically to protect sensitive electronic equipment from voltage transients induced by lightning and other transient voltage events.

Features

- RoHS compliant
- Typical maximum temperature coefficient $\Delta V_{BR} = 0.1\% \times V_{BR} @ 25^\circ\text{C}$
- Glass passivated chip junction in DO-41 Package
- 400W peak pulse capability at 10x1000µs waveform, repetition rate (duty cycles):0.01 %
- Fast response time: typically less than 1.0ps from 0 Volts to BV min
- Excellent clamping capability
- Low incremental surge resistance
- Typical I_R less than 1µA above 13V
- High temperature soldering guaranteed: 260°C/40 seconds / 0.375"(9.5mm) lead length, 5 lbs., (2.3kg) tension
- Plastic package has Underwriters Laboratory Flammability classification 94V-O
- Matte Tin Lead-free plated

Applications

TVS devices are ideal for the protection of I/O interfaces, V_{CC} bus and other vulnerable circuits used in telecom, computer, industrial and consumer electronic applications.

Transient Voltage Suppression Diodes

Axial Leaded – 400W > P4KE series

Electrical Characteristics

Part Number (Uni)	Part Number (Bi)	Reverse Stand off Voltage V_R (Volts)	Breakdown Voltage $V_{BR} @ I_T$ (V)		Test Current I_T (mA)	Maximum Clamping Voltage $V_C @ I_{PP}$ (V)	Maximum Peak Pulse Current I_{PP} (A)	Maximum Reverse Leakage $I_R @ V_R$ (μ A)	Agency Approval 
			MIN	MAX					
P4KE6.8A	P4KE6.8CA	5.80	6.45	7.14	10	10.5	39.00	1000	X
P4KE7.5A	P4KE7.5CA	6.40	7.13	7.88	10	11.3	36.30	500	X
P4KE8.2A	P4KE8.2CA	7.02	7.79	8.61	10	12.1	33.90	200	X
P4KE9.1A	P4KE9.1CA	7.78	8.65	9.55	1	13.4	30.60	50	X
P4KE10A	P4KE10CA	8.55	9.50	10.50	1	14.5	28.30	10	X
P4KE11A	P4KE11CA	9.40	10.50	11.60	1	15.6	26.30	5	X
P4KE12A	P4KE12CA	10.20	11.40	12.60	1	16.7	24.60	5	X
P4KE13A	P4KE13CA	11.10	12.40	13.70	1	18.2	22.50	1	X
P4KE15A	P4KE15CA	12.80	14.30	15.80	1	21.2	19.30	1	X
P4KE16A	P4KE16CA	13.60	15.20	16.80	1	22.5	18.20	1	X
P4KE18A	P4KE18CA	15.30	17.10	18.90	1	25.5	16.10	1	X
P4KE20A	P4KE20CA	17.10	19.00	21.00	1	27.7	14.80	1	X
P4KE22A	P4KE22CA	18.80	20.90	23.10	1	30.6	13.40	1	X
P4KE24A	P4KE24CA	20.50	22.80	25.20	1	33.2	12.30	1	X
P4KE27A	P4KE27CA	23.10	25.70	28.40	1	37.5	10.90	1	X
P4KE30A	P4KE30CA	25.60	28.50	31.50	1	41.4	9.90	1	X
P4KE33A	P4KE33CA	28.20	31.40	34.70	1	45.7	9.00	1	X
P4KE36A	P4KE36CA	30.80	34.20	37.80	1	49.9	8.20	1	X
P4KE39A	P4KE39CA	33.30	37.10	41.00	1	53.9	7.60	1	X
P4KE43A	P4KE43CA	36.80	40.90	45.20	1	59.3	6.90	1	X
P4KE47A	P4KE47CA	40.20	44.70	49.40	1	64.8	6.30	1	X
P4KE51A	P4KE51CA	43.60	48.50	53.60	1	70.1	5.80	1	X
P4KE56A	P4KE56CA	47.80	53.20	58.80	1	77.0	5.30	1	X
P4KE62A	P4KE62CA	53.00	58.90	65.10	1	85.0	4.80	1	X
P4KE68A	P4KE68CA	58.10	64.60	71.40	1	92.0	4.50	1	X
P4KE75A	P4KE75CA	64.10	71.30	78.80	1	103.0	4.00	1	X
P4KE82A	P4KE82CA	70.10	77.90	86.10	1	113.0	3.60	1	X
P4KE91A	P4KE91CA	77.80	86.50	95.50	1	125.0	3.30	1	X
P4KE100A	P4KE100CA	85.50	95.00	105.00	1	137.0	3.00	1	X
P4KE110A	P4KE110CA	94.00	105.00	116.00	1	152.0	2.70	1	X
P4KE120A	P4KE120CA	102.00	114.00	126.00	1	165.0	2.50	1	X
P4KE130A	P4KE130CA	111.00	124.00	137.00	1	179.0	2.30	1	X
P4KE150A	P4KE150CA	128.00	143.00	158.00	1	207.0	2.00	1	X
P4KE160A	P4KE160CA	136.00	152.00	168.00	1	219.0	1.90	1	X
P4KE170A	P4KE170CA	145.00	162.00	179.00	1	234.0	1.80	1	X
P4KE180A	P4KE180CA	154.00	171.00	189.00	1	246.0	1.70	1	X
P4KE200A	P4KE200CA	171.00	190.00	210.00	1	274.0	1.50	1	X
P4KE220A	P4KE220CA	185.00	209.00	231.00	1	328.0	1.30	1	X
P4KE250A	P4KE250CA	214.00	237.00	263.00	1	344.0	1.20	1	X
P4KE300A	P4KE300CA	256.00	285.00	315.00	1	414.0	1.00	1	X
P4KE350A	P4KE350CA	300.00	332.00	368.00	1	482.0	0.85	1	X
P4KE400A	P4KE400CA	342.00	380.00	420.00	1	548.0	0.75	1	X
P4KE440A	P4KE440CA	376.00	418.00	462.00	1	602.0	0.68	1	X
P4KE480A	P4KE480CA	408.00	456.00	504.00	1	658.0	0.61	1	
P4KE510A	P4KE510CA	434.00	485.00	535.00	1	698.0	0.57	1	
P4KE530A	P4KE530CA	477.00	503.50	556.50	1	725.0	0.55	1	
P4KE540A	P4KE540CA	486.00	513.00	567.00	1	740.0	0.54	1	
P4KE550A	P4KE550CA	495.00	522.50	577.50	1	760.0	0.52	1	

For bidirectional type having V_R of 10 volts and less, the I_R limit is double.

For parts without A, the V_{BR} is $\pm 10\%$ and V_C is 5% higher than with A parts

Ratings and Characteristic Curves ($T_A=25^\circ\text{C}$ unless otherwise noted)

Figure 1 - Peak Pulse Power Rating

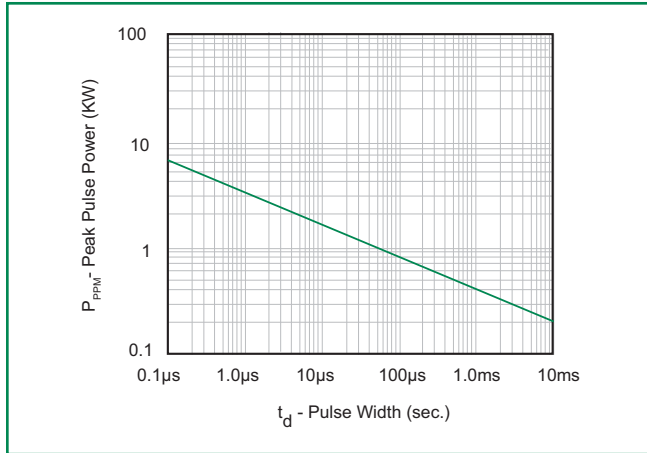

Figure 2 - Pulse Derating Curve

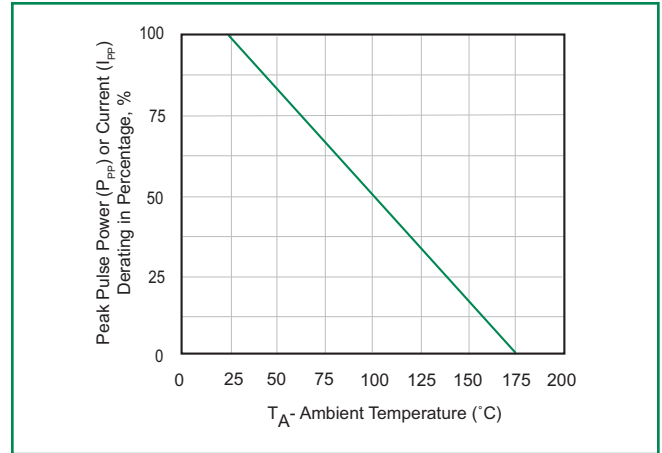

Figure 3 - Pulse Waveform

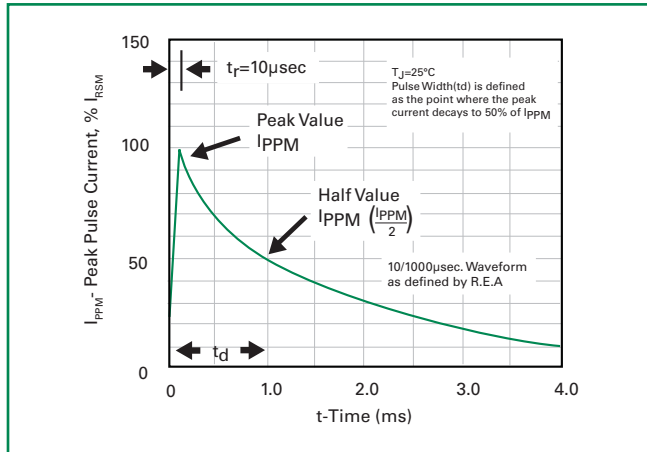

Figure 4 - Typical Junction Capacitance Uni-Directional

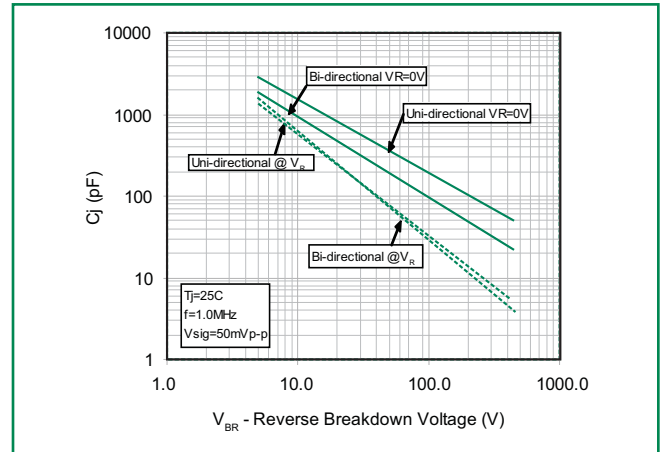

Figure 5 - Steady Pulse Derating Curve

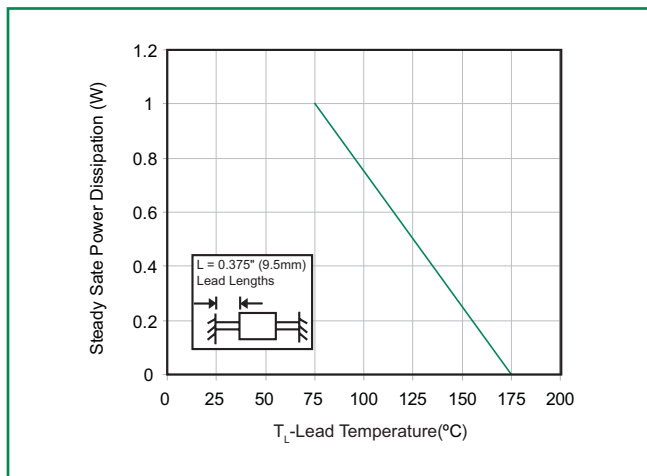
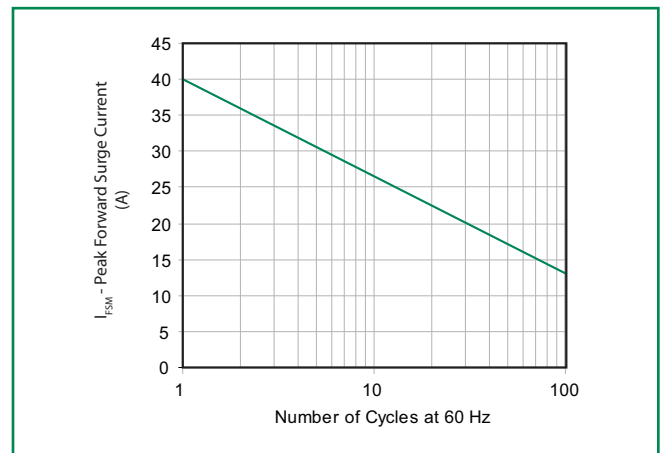
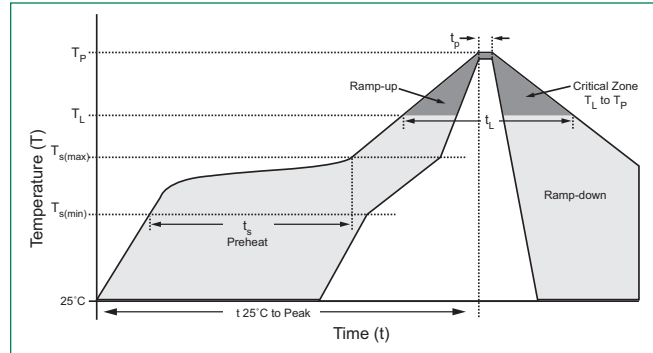

Figure 6 - Maximum Non-Repetitive Peak Forward Surge Current Uni-Directional Only



Soldering Parameters

Reflow Condition		Lead-free assembly
Pre Heat	- Temperature Min ($T_{s(min)}$)	150°C
	- Temperature Max ($T_{s(max)}$)	200°C
	- Time (min to max) (t_s)	60 – 180 secs
Average ramp up rate (Liquidus Temp (T_L) to peak)		3°C/second max
$T_{s(max)}$ to T_L - Ramp-up Rate		3°C/second max
Reflow	- Temperature (T_L) (Liquidus)	217°C
	- Time (min to max) (t_s)	60 – 150 seconds
Peak Temperature (T_p)		260 ^{+0/-5} °C
Time within 5°C of actual peak Temperature (t_p)		20 – 40 seconds
Ramp-down Rate		6°C/second max
Time 25°C to peak Temperature (T_p)		8 minutes Max.
Do not exceed		280°C



Flow/Wave Soldering (Solder Dipping)

Peak Temperature :	260°C
Dipping Time :	5 seconds
Soldering :	1 time

Physical Specifications

Weight	0.012oz., 0.3g
Case	JEDEC DO-204AL (DO-41) molded plastic body over passivated junction.
Polarity	Color band denotes the cathode except Bipolar.
Terminal	Matte Tin axial leads, solderable per JESD22-B102D.

Environmental Specifications

Temperature Cycle	JESD22-A104
Pressure Cooker	JESD 22-A102
High Temp. Storage	JESD22-A103
HTRB	JESD22-A108
Thermal Shock	JESD22-A106

Dimensions

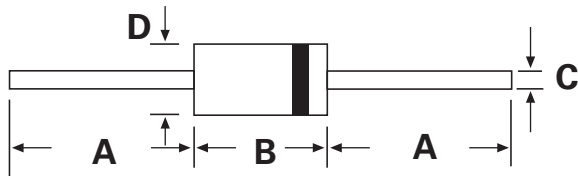

DO-204AL (DO-41)

Dimensions	Inches		Millimeters	
	Min	Max	Min	Max
A	1.000	-	25.40	-
B	0.160	0.205	4.10	5.20
C	0.028	0.034	0.71	0.86
D	0.080	0.107	2.00	2.70

Part Numbering System

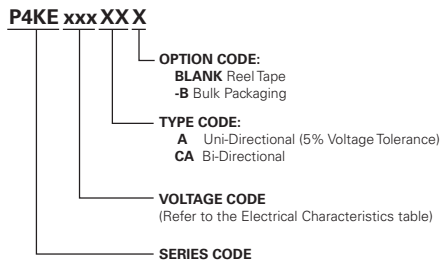

Part Marking System

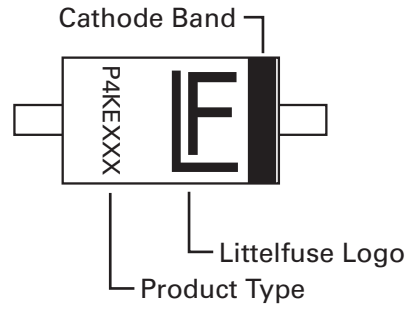

Packaging

Part Number	Component Package	Quantity	Packaging Option	Packaging Specification
P4KExxxXX	DO-204AL	5000	Tape & Reel	EIA STD RS-296E
P4KExxxXX-B	DO-204AL	500	BOX	Littelfuse Concord Packing Spec. DM-0016

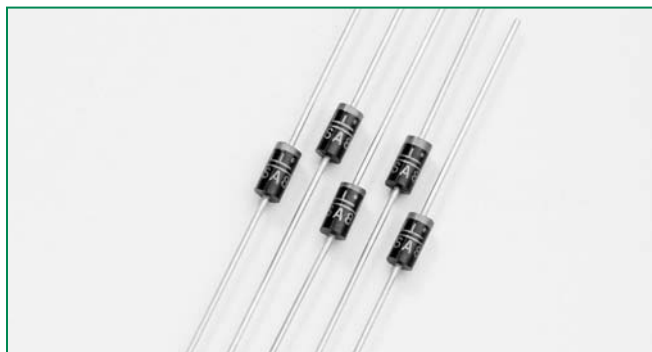

Agency Approvals

AGENCY	AGENCY FILE NUMBER
	E128662/E230531

Maximum Ratings and Thermal Characteristics (T_A=25°C unless otherwise noted)

Parameter	Symbol	Value	Unit
Peak Pulse Power Dissipation by 10x1000µs test waveform (Fig.1) (Note 1)	P _{PPM}	500	W
Steady State Power Dissipation on infinite heat sink at T _L =75°C (Fig. 5)	P _D	3.0	W
Peak Forward Surge Current, 8.3ms Single Half Sine Wave Unidirectional only (Note 2)	I _{FSM}	70	A
Maximum Instantaneous Forward Voltage at 35A for Unidirectional only (Note 3)	V _F	3.5/5.0	V
Operating Junction and Storage Temperature Range	T _J , T _{STG}	-55 to 175	°C
Typical Thermal Resistance Junction to Lead	R _{θJL}	20	°C/W
Typical Thermal Resistance Junction to Ambient	R _{θJA}	75	°C/W

Notes:

1. Non-repetitive current pulse, per Fig. 3 and derated above T_A = 25°C per Fig. 2.
2. Measured on 8.3ms single half sine wave or equivalent square wave, duty cycle=4 per minute maximum.
3. V_F<3.5V for devices of V_{BR} ≤ 200V and V_F<5.0V for devices of V_{BR} ≥ 201V.

Description

The SA Series is designed specifically to protect sensitive electronic equipment from voltage transients induced by lightning and other transient voltage events.

Features

- RoHS compliant
- Typical maximum temperature coefficient $\Delta V_{BR} = 0.1\% \times V_{BR} @ 25^\circ\text{C}$
- Glass passivated chip junction in DO-15 Package
- 500W peak pulse capability at 10x1000µs waveform, repetition rate (duty cycles):0.01%
- Fast response time: typically less than 1.0ps from 0 Volts to BV min
- Excellent clamping capability
- Low incremental surge resistance
- Typical I_R less than 1µA above 13V
- High temperature soldering guaranteed: 260°C/40 seconds / 0.375"(9.5mm) lead length, 5 lbs., (2.3kg) tension
- Plastic package has Underwriters Laboratory Flammability classification 94V-0
- Matte Tin Lead-free plated

Applications

TVS devices are ideal for the protection of I/O interfaces, V_{CC} bus and other vulnerable circuits used in telecom, computer, industrial and consumer electronic applications.

Electrical Characteristics

Part Number (Uni)	Part Number (Bi)	Reverse Stand off Voltage V_R (V)	Breakdown Voltage V_{BR} (Volts) @ I_T		Test Current I_T (mA)	Maximum Clamping Voltage V_C @ I_{PP} (V)	Maximum Peak Pulse Current I_{PP} (A)	Maximum Reverse Leakage I_R @ V_R (μ A)	Agency Approval 
			MIN	MAX					
SA5.0A	SA5.0CA	5.0	6.40	7.00	10	9.2	55.4	600	X
SA6.0A	SA6.0CA	6.0	6.67	7.37	10	10.3	49.5	600	X
SA6.5A	SA6.5CA	6.5	7.22	7.98	10	11.2	45.5	400	X
SA7.0A	SA7.0CA	7.0	7.78	8.60	10	12.0	42.5	150	X
SA7.5A	SA7.5CA	7.5	8.33	9.21	1	12.9	39.5	50	X
SA8.0A	SA8.0CA	8.0	8.89	9.83	1	13.6	37.5	25	X
SA8.5A	SA8.5CA	8.5	9.44	10.40	1	14.4	35.4	10	X
SA9.0A	SA9.0CA	9.0	10.00	11.10	1	15.4	33.1	5	X
SA10A	SA10CA	10.0	11.10	12.30	1	17.0	30.0	3	X
SA11A	SA11CA	11.0	12.20	13.50	1	18.2	28.0	1	X
SA12A	SA12CA	12.0	13.30	14.70	1	19.9	25.6	1	X
SA13A	SA13CA	13.0	14.40	15.90	1	21.5	23.7	1	X
SA14A	SA14CA	14.0	15.60	17.20	1	23.2	22.0	1	X
SA15A	SA15CA	15.0	16.70	18.50	1	24.4	20.9	1	X
SA16A	SA16CA	16.0	17.80	19.70	1	26.0	19.6	1	X
SA17A	SA17CA	17.0	18.90	20.90	1	27.6	18.5	1	X
SA18A	SA18CA	18.0	20.00	22.10	1	29.2	17.5	1	X
SA20A	SA20CA	20.0	22.20	24.50	1	32.4	15.7	1	X
SA22A	SA22CA	22.0	24.40	26.90	1	35.5	14.4	1	X
SA24A	SA24CA	24.0	26.70	29.50	1	38.9	13.1	1	X
SA26A	SA26CA	26.0	28.90	31.90	1	42.1	12.1	1	X
SA28A	SA28CA	28.0	31.10	34.40	1	45.4	11.2	1	X
SA30A	SA30CA	30.0	33.30	36.80	1	48.4	10.5	1	X
SA33A	SA33CA	33.0	36.70	40.60	1	53.3	9.6	1	X
SA36A	SA36CA	36.0	40.00	44.20	1	58.1	8.8	1	X
SA40A	SA40CA	40.0	44.40	49.10	1	64.5	7.9	1	X
SA43A	SA43CA	43.0	47.80	52.80	1	69.4	7.3	1	X
SA45A	SA45CA	45.0	50.00	55.30	1	72.7	7.0	1	X
SA48A	SA48CA	48.0	53.30	58.90	1	77.4	6.6	1	X
SA51A	SA51CA	51.0	56.70	62.70	1	82.4	6.2	1	X
SA54A	SA54CA	54.0	60.00	66.30	1	87.1	5.9	1	X
SA58A	SA58CA	58.0	64.40	71.20	1	93.6	5.4	1	X
SA60A	SA60CA	60.0	66.70	73.70	1	96.8	5.3	1	X
SA64A	SA64CA	64.0	71.10	78.60	1	103.0	5.0	1	X
SA70A	SA70CA	70.0	77.80	86.00	1	113.0	4.5	1	X
SA75A	SA75CA	75.0	83.30	92.10	1	121.0	4.2	1	X
SA78A	SA78CA	78.0	86.70	95.80	1	126.0	4.0	1	X
SA85A	SA85CA	85.0	94.40	104.00	1	137.0	3.7	1	X
SA90A	SA90CA	90.0	100.00	111.00	1	146.0	3.5	1	X
SA100A	SA100CA	100.0	111.00	123.00	1	162.0	3.1	1	X
SA110A	SA110CA	110.0	122.00	135.00	1	177.0	2.9	1	X
SA120A	SA120CA	120.0	133.00	147.00	1	193.0	2.6	1	X
SA130A	SA130CA	130.0	144.00	159.00	1	209.0	2.4	1	X
SA150A	SA150CA	150.0	167.00	185.00	1	243.0	2.1	1	X
SA160A	SA160CA	160.0	178.00	197.00	1	259.0	2.0	1	X
SA170A	SA170CA	170.0	189.00	209.00	1	275.0	1.9	1	X
SA180A	SA180CA	180.0	200.00	233.00	1	289.0	1.7	1	X

For bidirectional type having V_R of 10 volts and less, the I_R limit is double.

For parts without A, the V_{BR} is $\pm 10\%$.

Ratings and Characteristic Curves ($T_A=25^\circ\text{C}$ unless otherwise noted)

Figure 1 - Peak Pulse Power Rating Curve

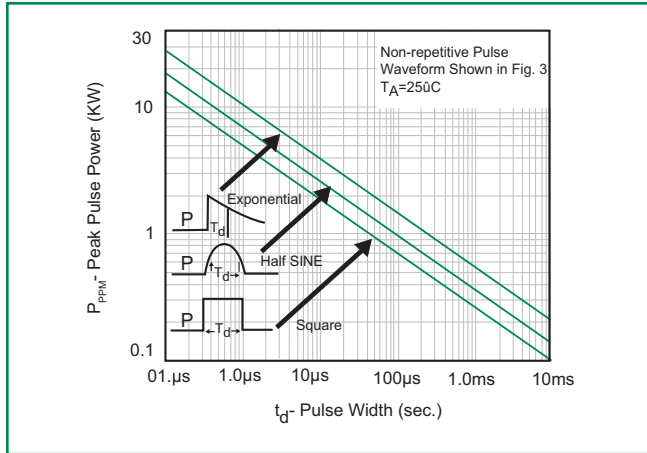

Figure 2 - Pulse Derating Curve

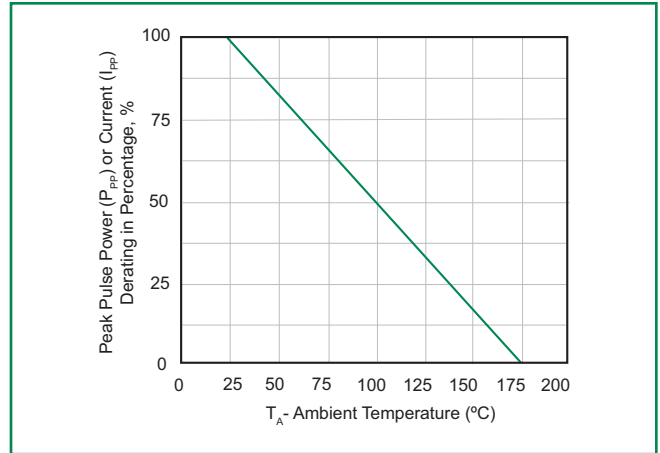

Figure 3 - Pulse Waveform

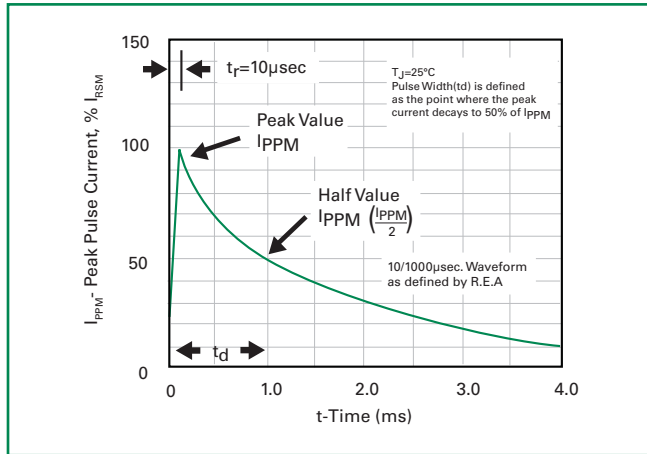

Figure 4 - Typical Junction Capacitance

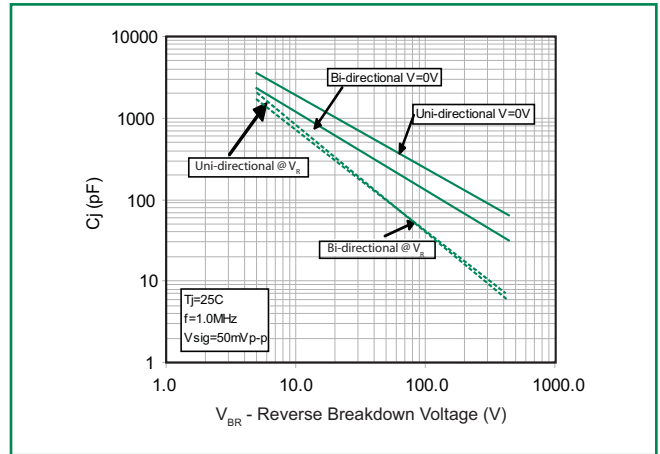

Figure 5 - Steady State Power Derating Curve

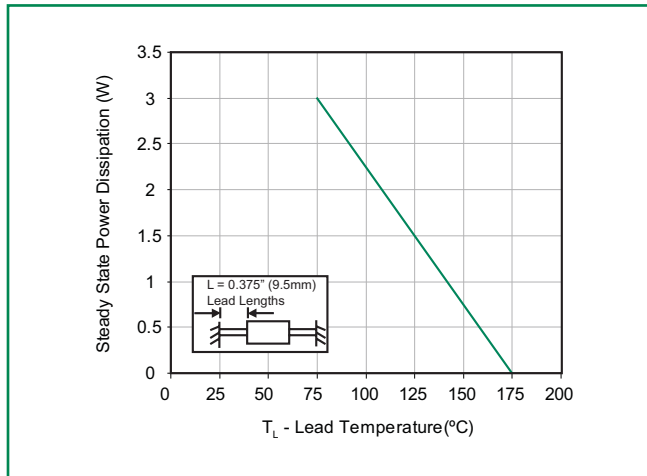
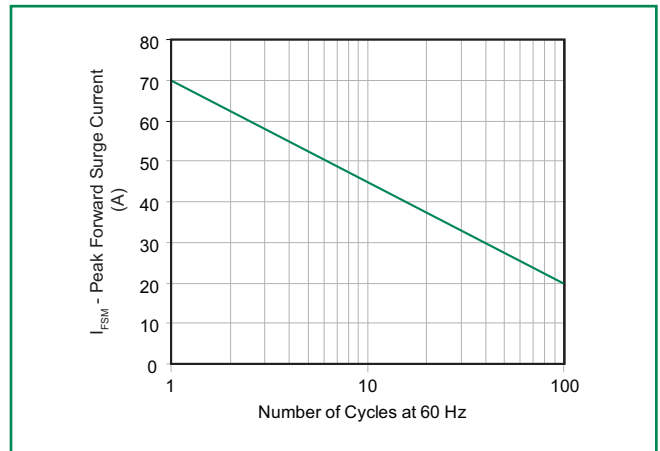
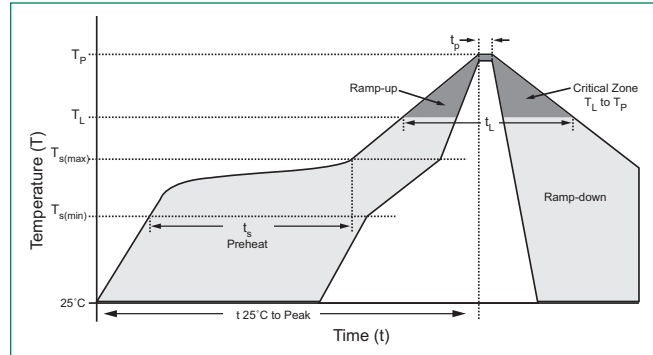

Figure 6 - Maximum Non-Repetitive Forward Surge Current Uni-Directional Only



Soldering Parameters

Reflow Condition		Lead-free assembly
Pre Heat	- Temperature Min ($T_{s(min)}$)	150°C
	- Temperature Max ($T_{s(max)}$)	200°C
	- Time (min to max) (t_s)	60 – 180 secs
Average ramp up rate (Liquidus Temp (T_L) to peak)		3°C/second max
$T_{s(max)}$ to T_L - Ramp-up Rate		3°C/second max
Reflow	- Temperature (T_L) (Liquidus)	217°C
	- Time (min to max) (t_s)	60 – 150 seconds
Peak Temperature (T_p)		260 ^{+0/-5} °C
Time within 5°C of actual peak Temperature (t_p)		20 – 40 seconds
Ramp-down Rate		6°C/second max
Time 25°C to peak Temperature (T_p)		8 minutes Max.
Do not exceed		280°C



Flow/Wave Soldering (Solder Dipping)

Peak Temperature :	265°C
Dipping Time :	10 seconds
Soldering :	1 time

Physical Specifications

Weight	0.015oz., 0.4g
Case	JEDEC DO-204AC (DO-15) molded plastic body over passivated junction.
Polarity	Color band denotes the cathode except Bipolar.
Terminal	Matte Tin axial leads, solderable per JESD22-B102D.

Environmental Specifications

Temperature Cycle	JESD22-A104
Pressure Cooker	JESD 22-A102
High Temp. Storage	JESD22-A103
HTRB	JESD22-A108
Thermal Shock	JESD22-A106

Dimensions

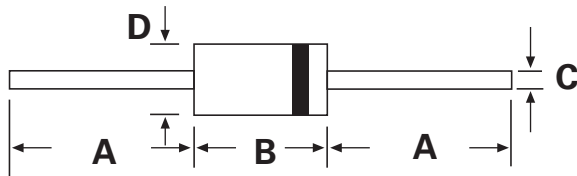

DO-204AC (DO-15)

Dimensions	Inches		Millimeters	
	Min	Max	Min	Max
A	1.000	-	25.40	-
B	0.230	0.300	5.80	7.60
C	0.028	0.034	0.71	0.86
D	0.104	0.140	2.60	3.60

Part Numbering System

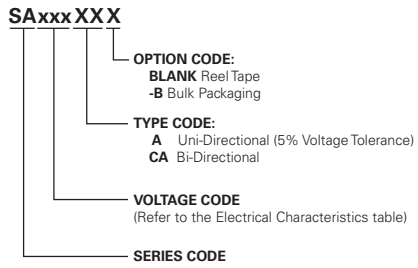

Part Marking System

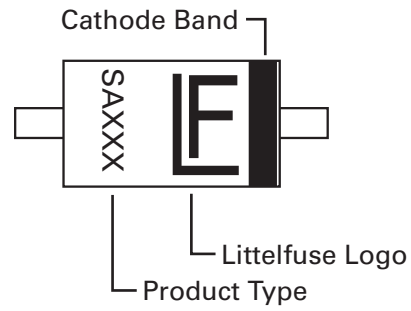

Packaging

Part Number	Component Package	Quantity	Packaging Option	Packaging Specification
SAxxxXX	DO-204AC	4000	Tape & Reel	EIA STD RS-296E
SAxxxXX-B	DO-204AC	1000	Bulk	Littelfuse Concord Packing Spec. DM-0016

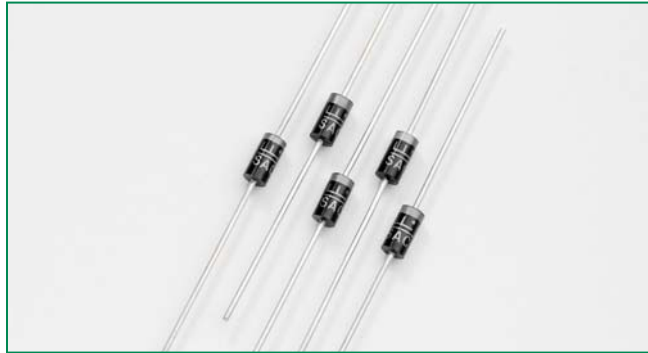
RoHS SAC Series

Description

The SAC Series is designed specifically to protect sensitive electronic equipment from voltage transients induced by lightning and other transient voltage events.

Features

- RoHS compliant
- Glass passivated chip junction in DO-15 Package
- 500W peak pulse power capability at 10x1000µs waveform, repetition rate (duty cycles):0.01%
- Fast response time: typically less than 1.0ps from 0 Volts to BV min
- Excellent clamping capability
- Low incremental surge resistance
- High temperature soldering guaranteed: 260°C/40 seconds / 0.375"(9.5mm) lead length, 5 lbs., (2.3kg) tension
- Plastic package has Underwriters Laboratory Flammability classification 94V-O
- Matte Tin Lead-free plated
- Ideal for data line applications

Agency Approvals

AGENCY	AGENCY FILE NUMBER
	E230531

Maximum Ratings and Thermal Characteristics (T_A=25°C unless otherwise noted)

Parameter	Symbol	Value	Unit
Peak Pulse Power Dissipation by 10x1000µs test waveform (Fig.1) (Note 1)	P _{PPM}	500	W
Steady State Power Dissipation on infinite heat sink at T _L =75°C (Fig. 5)	P _D	3.0	W
Operating Junction and Storage Temperature Range	T _J , T _{STG}	-55 to 175	°C

Note:

1. Non-repetitive current pulse, per Fig. 3 and derated above T_A = 25°C per Fig. 2.

Applications

TVS devices are ideal for the protection of I/O interfaces, V_{CC} bus and other vulnerable circuits used in telecom, computer, industrial and consumer electronic applications.

SAC Series
Electrical Characteristics

Part Number	Reverse Stand off Voltage V _R (V)	Breakdown Voltage V _{BR} (V)	Maximum Reverse Leakage I _R @ V _R (µA)	Maximum Clamping Voltage at I _{PP} =5.0A V _C (V)	Maximum Peak Pulse Current (Fig.3) I _{PP} (A)	Maximum Junction Capacitance @ 0 Volts (pF)	Working Inverse Blocking Voltage V _{WIB} (V)	Inverse Blocking Leakage Current at I _{IB} @ V _{WIB} (mA)	Peak Inverse Blocking Voltage V _{PIB} (V)	Agency Approval 
		MIN								
SAC5.0	5.0	7.60	300	10.0	44.0	50	75	1.0	100	X
SAC6.0	6.0	7.90	300	11.2	41.0	50	75	1.0	100	X
SAC7.0	7.0	8.33	300	12.6	38.0	50	75	1.0	100	X
SAC8.0	8.0	8.89	100	13.4	36.0	50	75	1.0	100	X
SAC8.5	8.5	9.44	50	14.0	34.0	50	75	1.0	100	X
SAC10	10.0	11.10	5	16.3	29.0	50	75	1.0	100	X
SAC12	12.0	13.30	1	19.0	25.0	50	75	1.0	100	X
SAC15	15.0	16.70	1	23.6	20.0	50	75	1.0	100	X
SAC18	18.0	20.00	1	28.8	15.0	50	75	1.0	100	X
SAC22	22.0	24.40	1	35.4	14.0	50	75	1.0	100	X
SAC26	26.0	28.90	1	42.3	11.1	50	75	1.0	100	X
SAC30	30.0	33.30	1	48.6	10.0	50	75	1.0	100	X
SAC36	36.0	40.00	1	60.0	8.6	50	75	1.0	100	X
SAC45	45.0	50.00	1	77.0	6.8	50	150	1.0	200	X
SAC50	50.0	55.50	1	88.0	5.8	50	150	1.0	200	X

Ratings and Characteristic Curves ($T_A=25^\circ\text{C}$ unless otherwise noted)

Figure 1 - Peak Pulse Power Rating Curve

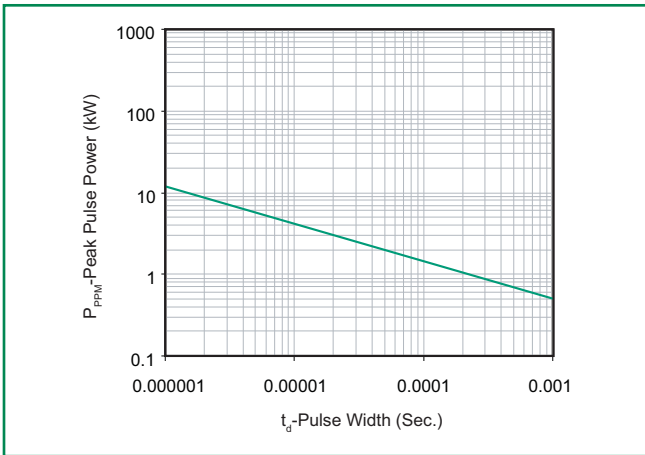

Figure 2 - Pulse Derating Curve

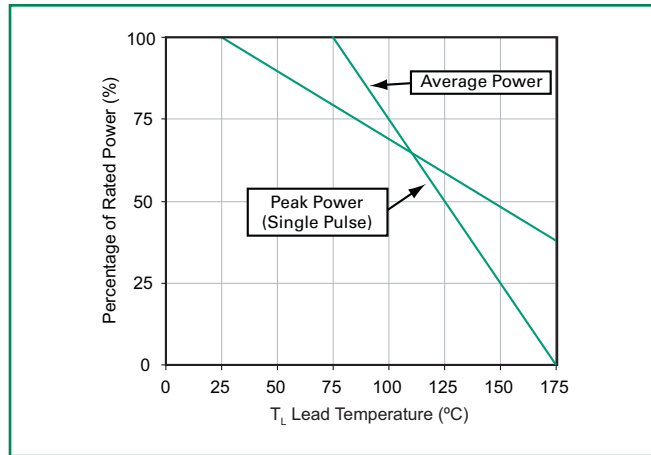

Figure 3 - Pulse Waveform

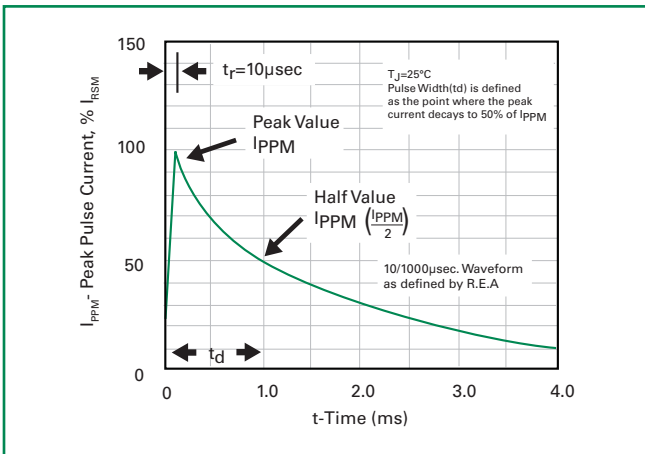

Figure 4 - AC Line Protection Application

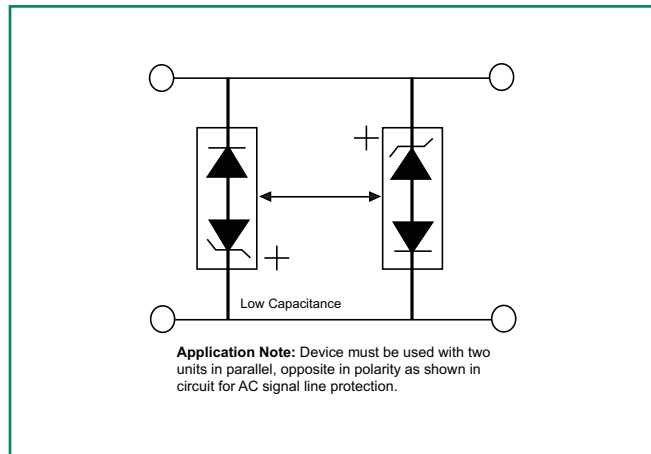
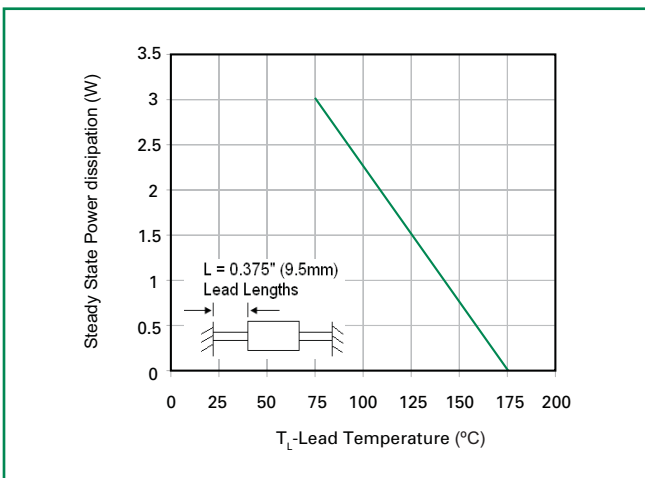
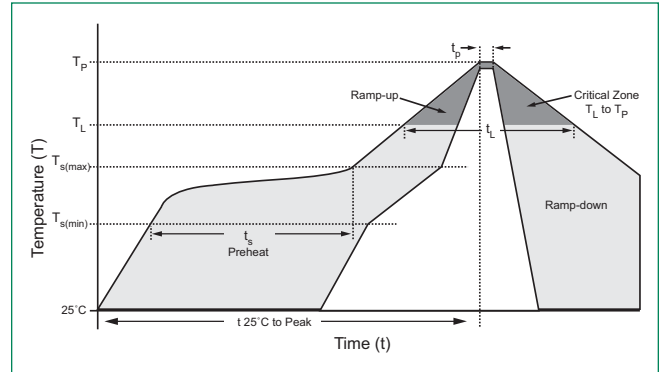

Figure 5 - Steady State Power Derating Curve



Soldering Parameters

Reflow Condition		Lead-free assembly
Pre Heat	- Temperature Min ($T_{s(min)}$)	150°C
	- Temperature Max ($T_{s(max)}$)	200°C
	- Time (min to max) (t_s)	60 – 180 secs
Average ramp up rate (Liquidus Temp (T_L) to peak)		3°C/second max
$T_{s(max)}$ to T_L - Ramp-up Rate		3°C/second max
Reflow	- Temperature (T_L) (Liquidus)	217°C
	- Time (min to max) (t_s)	60 – 150 seconds
Peak Temperature (T_p)		260 ^{+0/-5} °C
Time within 5°C of actual peak Temperature (t_p)		20 – 40 seconds
Ramp-down Rate		6°C/second max
Time 25°C to peak Temperature (T_p)		8 minutes Max.
Do not exceed		280°C



Flow/Wave Soldering (Solder Dipping)

Peak Temperature :	265°C
Dipping Time :	10 seconds
Soldering :	1 time

Physical Specifications

Weight	0.015oz., 0.4g
Case	JEDEC DO-204AC (DO-15) molded plastic body over passivated junction.
Polarity	Color band denotes the cathode except Bipolar.
Terminal	Matte Tin axial leads, solderable per JESD22-B102D.

Environmental Specifications

Temperature Cycle	JESD22-A104
Pressure Cooker	JESD 22-A102
High Temp. Storage	JESD22-A103
HTRB	JESD22-A108
Thermal Shock	JESD22-A106

Dimensions

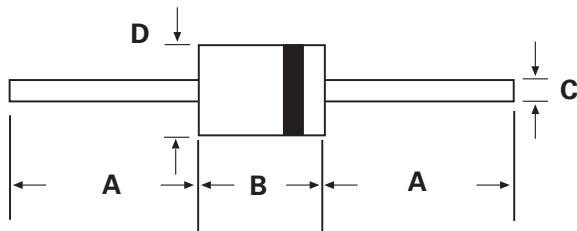

DO-204AC (DO-15)

Dimensions	Inches		Millimeters	
	Min	Max	Min	Max
A	1.000	-	25.40	-
B	0.230	0.300	5.80	7.60
C	0.028	0.034	0.71	0.86
D	0.104	0.140	2.60	3.60

Part Numbering System

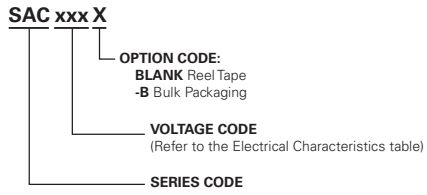

Part Marking System

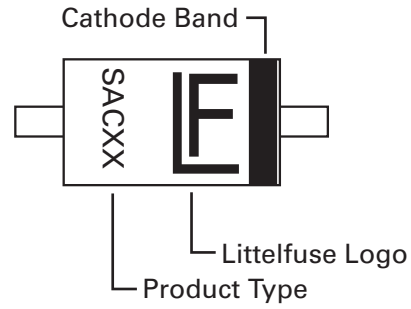

Packaging

Part Number	Component Package	Quantity	Packaging Option	Packaging Specification
SACxxxXX	DO-204AC	4000	Tape & Reel	EIA STD RS-296E
SACxxxXX-B	DO-204AC	1000	BULK	Littelfuse Concord Packing Spec. DM-0016

Schematic



RoHS P6KE Series

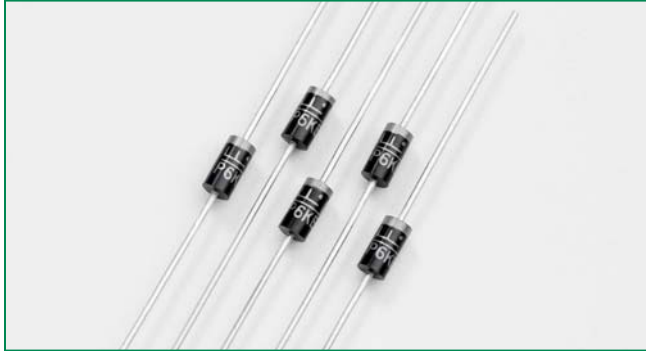

Description

The P6KE Series is designed specifically to protect sensitive electronic equipment from voltage transients induced by lightning and other transient voltage events.

Features

- RoHS compliant
- Typical maximum temperature coefficient $\Delta V_{BR} = 0.1\% \times V_{BR} @ 25^\circ\text{C}$
- Glass passivated chip junction in DO-15 Package
- 600W peak pulse capability at 10x1000µs waveform, repetition rate (duty cycles):0.01%
- Fast response time: typically less than 1.0ps from 0 Volts to BV min
- Excellent clamping capability
- Low incremental surge resistance
- Typical I_R less than 1µA above 13V
- High temperature soldering guaranteed: 260°C/40 seconds / 0.375"(9.5mm) lead length, 5 lbs., (2.3kg) tension
- Plastic package has Underwriters Laboratory Flammability classification 94V-0
- Matte Tin Lead-free plated

Agency Approvals

AGENCY	AGENCY FILE NUMBER
	E128662/E230531

Maximum Ratings and Thermal Characteristics (T_A=25°C unless otherwise noted)

Parameter	Symbol	Value	Unit
Peak Pulse Power Dissipation by 10x1000µs test waveform (Fig.1) (Note 1)	P _{PPM}	600	W
Steady State Power Dissipation on infinite heat sink at T _L =75°C (Fig. 5)	P _D	5.0	W
Peak Forward Surge Current, 8.3ms Single Half Sine Wave Unidirectional only (Note 2)	I _{FSM}	100	A
Maximum Instantaneous Forward Voltage at 50A for Unidirectional only (Note 3)	V _F	3.5/5.0	V
Operating Junction and Storage Temperature Range	T _J , T _{STG}	-55 to 175	°C
Typical Thermal Resistance Junction to Lead	R _{uJL}	20	°C/W
Typical Thermal Resistance Junction to Ambient	R _{uJA}	75	°C/W

Notes:

1. Non-repetitive current pulse, per Fig. 3 and derated above T_A = 25°C per Fig. 2.
2. Measured on 8.3ms single half sine wave or equivalent square wave, duty cycle=4 per minute maximum.
3. V_F<3.5V for devices of V_{BR} ≤ 200V and V_F< 5.0V for devices of V_{BR} ≥ 201V.

Applications

TVS devices are ideal for the protection of I/O interfaces, V_{CC} bus and other vulnerable circuits used in telecom, computer, industrial and consumer electronic applications.

P6KE Series

Transient Voltage Suppression Diodes

Axial Leaded – 600W > P6KE series

Electrical Characteristics

Part Number (Uni)	Part Number (Bi)	Reverse Stand off Voltage V_R (Volts)	Breakdown Voltage V_{BR} (Volts) @ I_T		Test Current I_T (mA)	Maximum Clamping Voltage V_C @ I_{PP} (V)	Maximum Peak Pulse Current I_{PP} (A)	Maximum Reverse Leakage I_R @ V_R (μ A)	Agency Approval 
			MIN	MAX					
P6KE6.8A	P6KE6.8CA	5.80	6.45	7.14	10	10.5	58.1	1000	X
P6KE7.5A	P6KE7.5CA	6.40	7.13	7.88	10	11.3	54.0	500	X
P6KE8.2A	P6KE8.2CA	7.02	7.79	8.61	10	12.1	50.4	200	X
P6KE9.1A	P6KE9.1CA	7.78	8.65	9.55	1	13.4	45.5	50	X
P6KE10A	P6KE10CA	8.55	9.50	10.50	1	14.5	42.1	10	X
P6KE11A	P6KE11CA	9.40	10.50	11.60	1	15.6	39.1	5	X
P6KE12A	P6KE12CA	10.20	11.40	12.60	1	16.7	36.5	5	X
P6KE13A	P6KE13CA	11.10	12.40	13.70	1	18.2	33.5	1	X
P6KE15A	P6KE15CA	12.80	14.30	15.80	1	21.2	28.8	1	X
P6KE16A	P6KE16CA	13.60	15.20	16.80	1	22.5	27.1	1	X
P6KE18A	P6KE18CA	15.30	17.10	18.90	1	25.2	24.2	1	X
P6KE20A	P6KE20CA	17.10	19.00	21.00	1	27.7	22.0	1	X
P6KE22A	P6KE22CA	18.80	20.90	23.10	1	30.6	19.9	1	X
P6KE24A	P6KE24CA	20.50	22.80	25.20	1	33.2	18.4	1	X
P6KE27A	P6KE27CA	23.10	25.70	28.40	1	37.5	16.3	1	X
P6KE30A	P6KE30CA	25.60	28.50	31.50	1	41.4	14.7	1	X
P6KE33A	P6KE33CA	28.20	31.40	34.70	1	45.7	13.3	1	X
P6KE36A	P6KE36CA	30.80	34.20	37.80	1	49.9	12.2	1	X
P6KE39A	P6KE39CA	33.30	37.10	41.00	1	53.9	11.3	1	X
P6KE43A	P6KE43CA	36.80	40.90	45.20	1	59.3	10.3	1	X
P6KE47A	P6KE47CA	40.20	44.70	49.40	1	64.8	9.4	1	X
P6KE51A	P6KE51CA	43.60	48.50	53.60	1	70.1	8.7	1	X
P6KE56A	P6KE56CA	47.80	53.20	58.80	1	77.0	7.9	1	X
P6KE62A	P6KE62CA	53.00	58.90	65.10	1	85.0	7.2	1	X
P6KE68A	P6KE68CA	58.10	64.60	71.40	1	92.0	6.6	1	X
P6KE75A	P6KE75CA	64.10	71.30	78.80	1	103.0	5.9	1	X
P6KE82A	P6KE82CA	70.10	77.90	86.10	1	113.0	5.4	1	X
P6KE91A	P6KE91CA	77.80	86.50	95.50	1	125.0	4.9	1	X
P6KE100A	P6KE100CA	85.50	95.00	105.00	1	137.0	4.5	1	X
P6KE110A	P6KE110CA	94.00	105.00	116.00	1	152.0	4.0	1	X
P6KE120A	P6KE120CA	102.00	114.00	126.00	1	165.0	3.7	1	X
P6KE130A	P6KE130CA	111.00	124.00	137.00	1	179.0	3.4	1	X
P6KE150A	P6KE150CA	128.00	143.00	158.00	1	207.0	2.9	1	X
P6KE160A	P6KE160CA	136.00	152.00	168.00	1	219.0	2.8	1	X
P6KE170A	P6KE170CA	145.00	162.00	179.00	1	234.0	2.6	1	X
P6KE180A	P6KE180CA	154.00	171.00	189.00	1	246.0	2.5	1	X
P6KE200A	P6KE200CA	171.00	190.00	210.00	1	274.0	2.2	1	X
P6KE220A	P6KE220CA	185.00	209.00	231.00	1	328.0	1.9	1	X
P6KE250A	P6KE250CA	214.00	237.00	263.00	1	344.0	1.8	1	X
P6KE300A	P6KE300CA	256.00	285.00	315.00	1	414.0	1.5	1	X
P6KE350A	P6KE350CA	300.00	332.00	368.00	1	482.0	1.3	1	X
P6KE400A	P6KE400CA	342.00	380.00	420.00	1	548.0	1.1	1	X
P6KE440A	P6KE440CA	376.00	418.00	462.00	1	602.0	1.0	1	X
P6KE480A	P6KE480CA	408.00	456.00	504.00	1	658.0	0.9	1	
P6KE510A	P6KE510CA	434.00	485.00	535.00	1	698.0	0.9	1	
P6KE530A	P6KE530CA	477.00	503.50	556.50	1	725.0	0.8	1	
P6KE540A	P6KE540CA	486.00	513.00	567.00	1	740.0	0.8	1	
P6KE550A	P6KE550CA	495.00	522.50	577.50	1	760.0	0.8	1	
P6KE600A	P6KE600CA	512.00	570.00	630.00	1	828.0	0.75	1	

For bidirectional type having V_R of 10 volts and less, the I_R limit is double.

For parts without A, the V_{BR} is $\pm 10\%$ and V_C is 5% higher than with A parts

Ratings and Characteristic Curves ($T_A=25^\circ\text{C}$ unless otherwise noted)

Figure 1 - Peak Pulse Power Rating

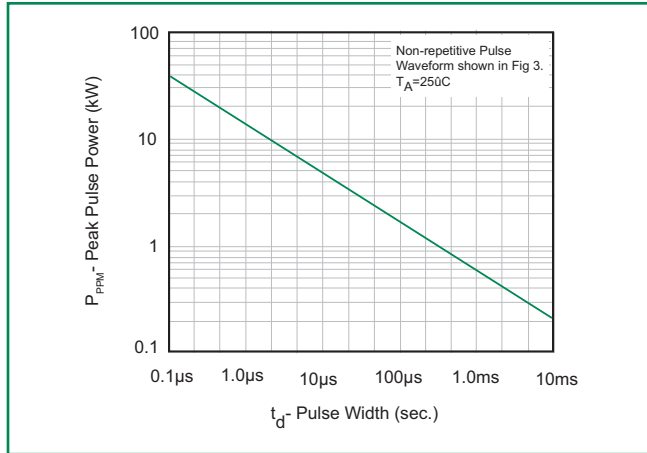

Figure 2 - Pulse Derating Curve

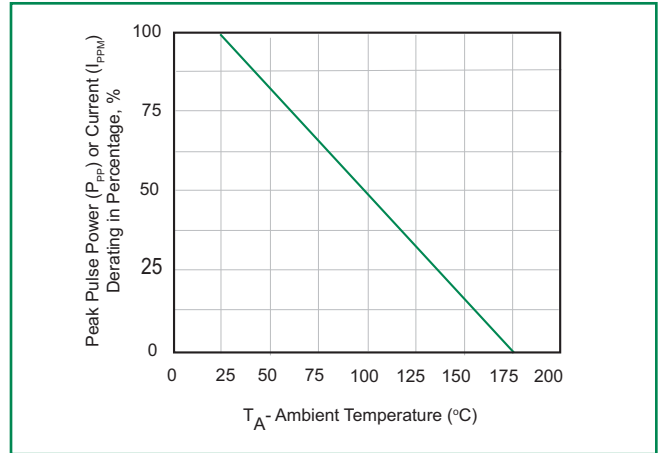

Figure 3 - Pulse Waveform

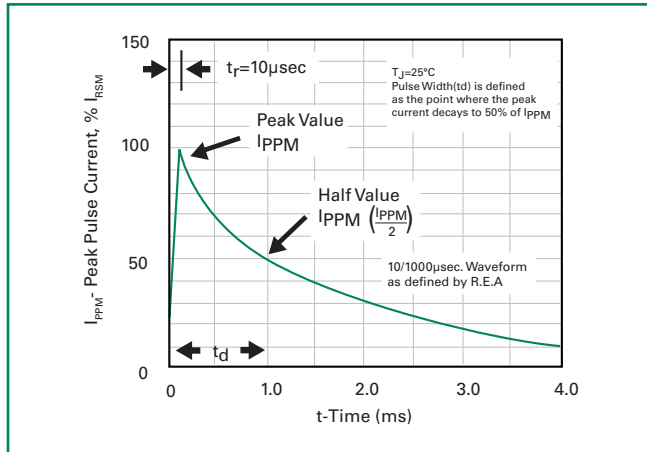

Figure 4 - Typical Junction Capacitance Uni-Directional

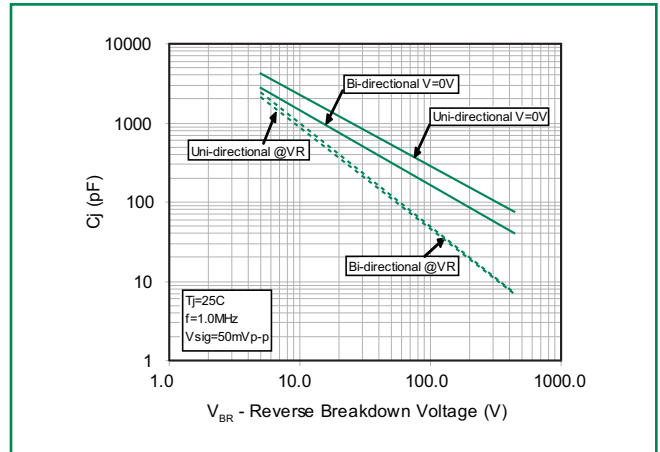

Figure 5 - Steady State Power Derating Curve

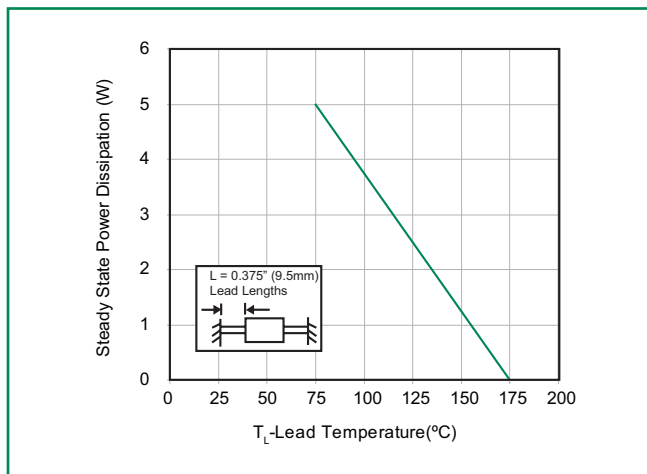
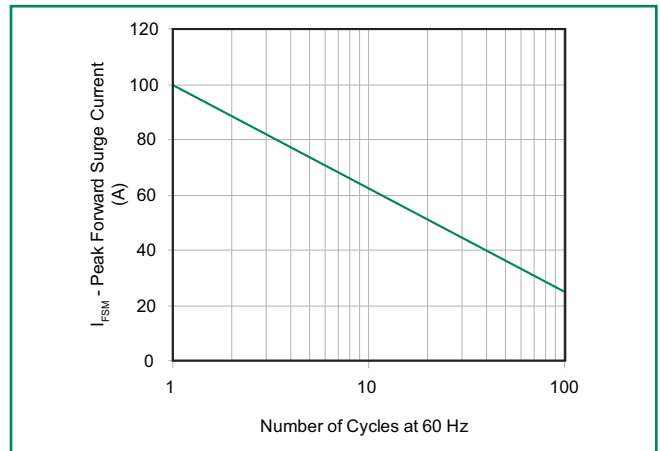
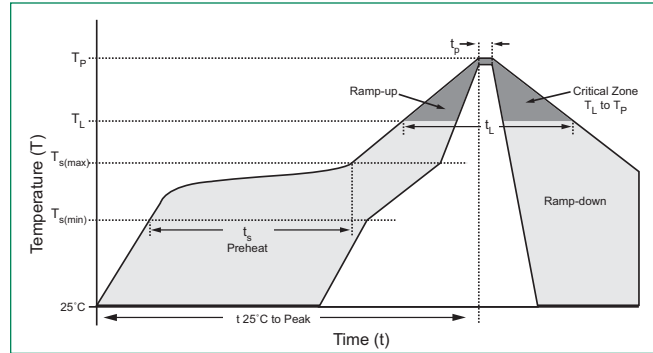

Figure 6 - Maximum Non-Repetitive Forward Surge Current



Soldering Parameters

Reflow Condition		Lead-free assembly
Pre Heat	- Temperature Min ($T_{s(min)}$)	150°C
	- Temperature Max ($T_{s(max)}$)	200°C
	- Time (min to max) (t_s)	60 – 180 secs
Average ramp up rate (Liquidus Temp (T_L) to peak)		3°C/second max
$T_{s(max)}$ to T_L - Ramp-up Rate		3°C/second max
Reflow	- Temperature (T_L) (Liquidus)	217°C
	- Time (min to max) (t_s)	60 – 150 seconds
Peak Temperature (T_p)		260 ^{+0/-5} °C
Time within 5°C of actual peak Temperature (t_p)		20 – 40 seconds
Ramp-down Rate		6°C/second max
Time 25°C to peak Temperature (T_p)		8 minutes Max.
Do not exceed		280°C



Flow/Wave Soldering (Solder Dipping)

Peak Temperature :	265°C
Dipping Time :	10 seconds
Soldering :	1 time

Physical Specifications

Weight	0.015oz., 0.4g
Case	JEDEC DO-204AC (DO-15) molded plastic body over passivated junction.
Polarity	Color band denotes the cathode except Bipolar.
Terminal	Matte Tin axial leads, solderable per JESD22-B102D.

Environmental Specifications

Temperature Cycle	JESD22-A104
Pressure Cooker	JESD 22-A102
High Temp. Storage	JESD22-A103
HTRB	JESD22-A108
Thermal Shock	JESD22-A106

Dimensions

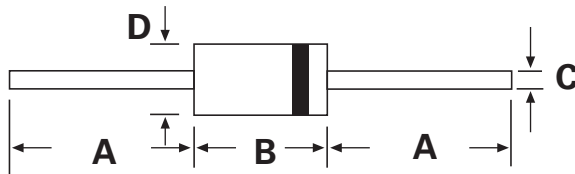

DO-204AC (DO-15)

Dimensions	Inches		Millimeters	
	Min	Max	Min	Max
A	1.000	-	25.40	-
B	0.230	0.300	5.80	7.60
C	0.028	0.034	0.71	0.86
D	0.104	0.140	2.60	3.60

Part Numbering System

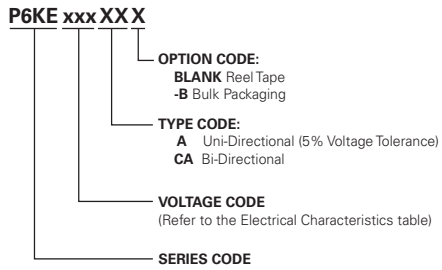

Part Marking System

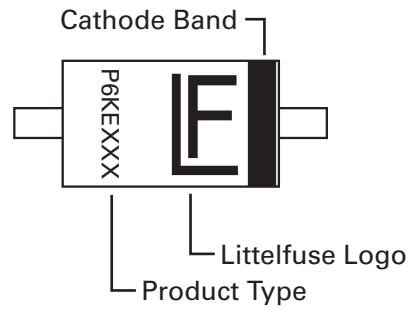

Packaging

Part Number	Component Package	Quantity	Packaging Option	Packaging Specification
P6KExxxXX	DO-204AC	4000	Tape & Reel	EIA STD RS-296E
P6KExxxXX-B	DO-204AC	1000	BULK	Littelfuse Concord Packing Spec. DM-0016

RoHS 1.5KE Series

Agency Approvals

AGENCY	AGENCY FILE NUMBER
	E128662/E230531

**Maximum Ratings and Thermal Characteristics
(T_A=25°C unless otherwise noted)**

Parameter	Symbol	Value	Unit
Peak Pulse Power Dissipation by 10x1000µs test waveform (Fig.1) (Note 1)	P _{PPM}	1500	W
Steady State Power Dissipation on infinite heat sink at T _L =75°C (Fig. 5)	P _D	6.5	W
Peak Forward Surge Current, 8.3ms Single Half Sine Wave Unidirectional only (Note 2)	I _{FSM}	200	A
Maximum Instantaneous Forward Voltage at 100A for Unidirectional only (Note 3)	V _F	3.5/5.0	V
Operating Junction and Storage Temperature Range	T _J , T _{STG}	-55 to 175	°C
Typical Thermal Resistance Junction to Lead	R _{θJL}	15	°C/W
Typical Thermal Resistance Junction to Ambient	R _{θJA}	75	°C/W

Notes:

1. Non-repetitive current pulse, per Fig. 3 and derated above T_A = 25°C per Fig. 2.
2. Measured on 8.3ms single half sine wave or equivalent square wave, duty cycle=4 per minute maximum.
3. V_F<3.5V for devices of V_{BR} ≤ 200V and V_F<5.0V for devices of V_{BR} ≥ 201V.

Description

The 1.5KE Series is designed specifically to protect sensitive electronic equipment from voltage transients induced by lightning and other transient voltage events.

Features

- RoHS compliant
- Typical maximum temperature coefficient $\Delta V_{BR} = 0.1\% \times V_{BR} @ 25^\circ\text{C}$
- Glass passivated chip junction in DO-201 Package
- 1500W peak pulse capability at 10x1000µs waveform, repetition rate (duty cycles):0.01 %
- Fast response time: typically less than 1.0ps from 0 Volts to BV min
- Excellent clamping capability
- Low incremental surge resistance
- Typical I_R less than 1µA above 13V
- High temperature soldering guaranteed: 260°C/40 seconds / 0.375";(9.5mm) lead length, 5 lbs., (2.3kg) tension
- Plastic package has Underwriters Laboratory Flammability classification 94V-O
- Matte Tin Lead-free plated

Applications

TVS devices are ideal for the protection of I/O interfaces, V_{CC} bus and other vulnerable circuits used in telecom, computer, industrial and consumer electronic applications.

Transient Voltage Suppression Diodes

Axial Leaded – 1500W > 1.5KE series

Electrical Characteristics

Part Number (Uni)	Part Number (Bi)	Reverse Stand off Voltage V_R (Volts)	Breakdown Voltage V_{BR} (Volts) @ I_T		Test Current I_T (mA)	Maximum Clamping Voltage V_C @ I_{PP} (Volts)	Maximum Peak Pulse Current I_{PP} (A)	Maximum Reverse Leakage I_R @ V_R (μ A)	Agency Approval 
			MIN	MAX					
1.5KE6.8A	1.5KE6.8CA	5.80	6.45	7.14	10	10.5	144.8	1000	X
1.5KE7.5A	1.5KE7.5CA	6.40	7.13	7.88	10	11.3	134.5	500	X
1.5KE8.2A	1.5KE8.2CA	7.02	7.79	8.61	10	12.1	125.6	200	X
1.5KE9.1A	1.5KE9.1CA	7.78	8.65	9.50	1	13.4	113.4	50	X
1.5KE10A	1.5KE10CA	8.55	9.50	10.50	1	14.5	104.8	10	X
1.5KE11A	1.5KE11CA	9.40	10.50	11.60	1	15.6	97.4	5	X
1.5KE12A	1.5KE12CA	10.20	11.40	12.60	1	16.7	91.0	5	X
1.5KE13A	1.5KE13CA	11.10	12.40	13.70	1	18.2	83.5	1	X
1.5KE15A	1.5KE15CA	12.80	14.30	15.80	1	21.2	71.7	1	X
1.5KE16A	1.5KE16CA	13.60	15.20	16.80	1	22.5	67.6	1	X
1.5KE18A	1.5KE18CA	15.30	17.10	18.90	1	25.2	60.3	1	X
1.5KE20A	1.5KE20CA	17.10	19.00	21.00	1	27.7	54.9	1	X
1.5KE22A	1.5KE22CA	18.80	20.90	23.10	1	30.6	49.7	1	X
1.5KE24A	1.5KE24CA	20.50	22.80	25.20	1	33.2	45.8	1	X
1.5KE27A	1.5KE27CA	23.10	25.70	28.40	1	37.5	40.5	1	X
1.5KE30A	1.5KE30CA	25.60	28.50	31.50	1	41.4	36.7	1	X
1.5KE33A	1.5KE33CA	28.20	31.40	34.70	1	45.7	33.3	1	X
1.5KE36A	1.5KE36CA	30.80	34.20	37.80	1	49.9	30.5	1	X
1.5KE39A	1.5KE39CA	33.30	37.10	41.00	1	53.9	28.2	1	X
1.5KE43A	1.5KE43CA	36.80	40.90	45.20	1	59.3	25.6	1	X
1.5KE47A	1.5KE47CA	40.20	44.70	49.40	1	64.8	23.5	1	X
1.5KE51A	1.5KE51CA	43.60	48.50	53.60	1	70.1	21.7	1	X
1.5KE56A	1.5KE56CA	47.80	53.20	58.80	1	77.0	19.7	1	X
1.5KE62A	1.5KE62CA	53.00	58.90	65.10	1	85.0	17.9	1	X
1.5KE68A	1.5KE68CA	58.10	64.60	71.40	1	92.0	16.5	1	X
1.5KE75A	1.5KE75CA	64.10	71.30	78.80	1	103.0	14.8	1	X
1.5KE82A	1.5KE82CA	70.10	77.90	86.10	1	113.0	13.5	1	X
1.5KE91A	1.5KE91CA	77.80	86.50	95.50	1	125.0	12.2	1	X
1.5KE100A	1.5KE100CA	85.50	95.00	105.00	1	137.0	11.1	1	X
1.5KE110A	1.5KE110CA	94.00	105.00	116.00	1	152.0	10.0	1	X
1.5KE120A	1.5KE120CA	102.00	114.00	126.00	1	165.0	9.2	1	X
1.5KE130A	1.5KE130CA	111.00	124.00	137.00	1	179.0	8.5	1	X
1.5KE150A	1.5KE150CA	128.00	143.00	158.00	1	207.0	7.3	1	X
1.5KE160A	1.5KE160CA	136.00	152.00	168.00	1	219.0	6.9	1	X
1.5KE170A	1.5KE170CA	145.00	162.00	179.00	1	234.0	6.5	1	X
1.5KE180A	1.5KE180CA	154.00	171.00	189.00	1	246.0	6.2	1	X
1.5KE200A	1.5KE200CA	171.00	190.00	210.00	1	274.0	5.5	1	X
1.5KE220A	1.5KE220CA	185.00	209.00	231.00	1	328.0	4.6	1	X
1.5KE250A	1.5KE250CA	214.00	237.00	263.00	1	344.0	4.4	1	X
1.5KE300A	1.5KE300CA	256.00	285.00	315.00	1	414.0	3.7	1	X
1.5KE350A	1.5KE350CA	300.00	332.00	368.00	1	482.0	3.2	1	X
1.5KE400A	1.5KE400CA	342.00	380.00	420.00	1	548.0	2.8	1	X
1.5KE440A	1.5KE440CA	376.00	418.00	462.00	1	602.0	2.5	1	X
1.5KE480A	1.5KE480CA	408.00	456.00	504.00	1	658.0	2.3	1	X
1.5KE510A	1.5KE510CA	434.00	485.00	535.00	1	698.0	2.1	1	X
1.5KE530A	1.5KE530CA	477.00	503.50	556.50	1	725.0	2.1	1	X
1.5KE540A	1.5KE540CA	459.00	513.00	567.00	1	740.0	2.0	1	X
1.5KE550A	1.5KE550CA	495.00	522.50	577.50	1	760.0	2.0	1	X

For bidirectional type having V_R of 10 volts and less, the I_R limit is double.

For parts without A, the V_{BR} is $\pm 10\%$ and V_C is 5% higher than with A parts.

Ratings and Characteristic Curves ($T_A=25^\circ\text{C}$ unless otherwise noted)

Figure 1 - Peak Pulse Power Rating Curve

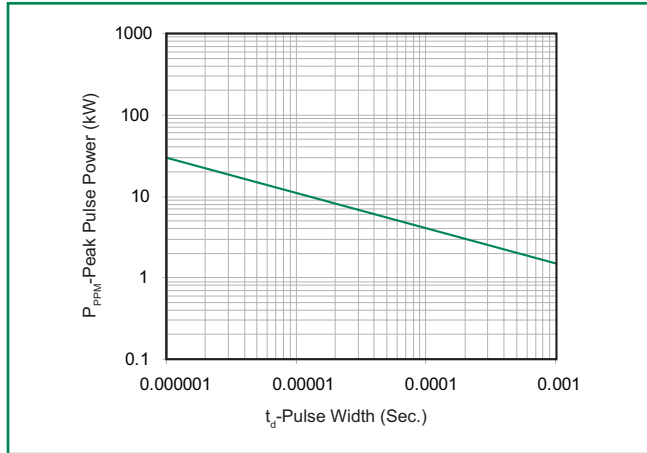

Figure 2 - Pulse Derating Curve

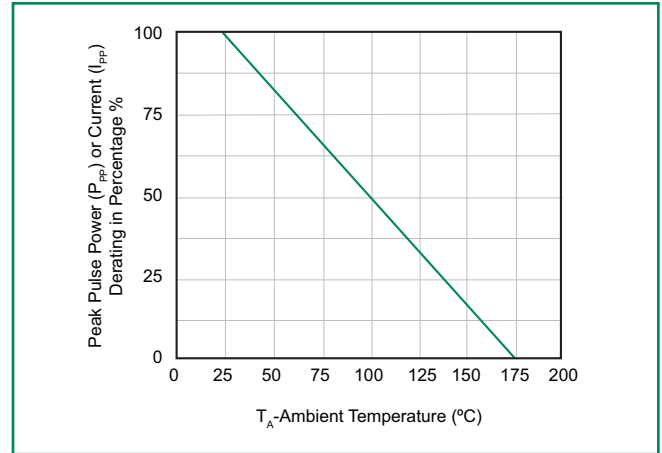

Figure 3 - Pulse Waveform

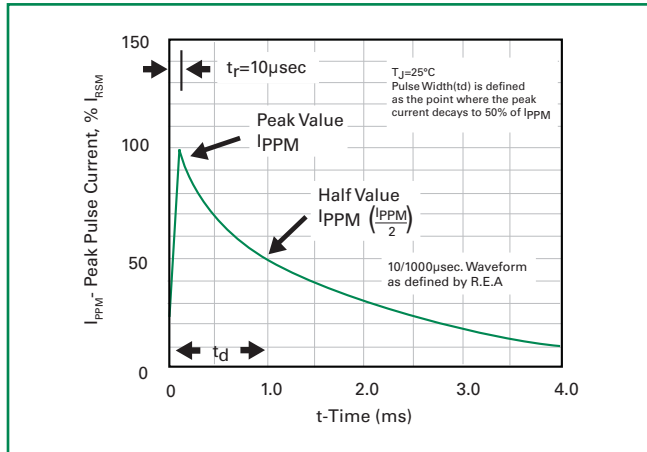

Figure 4 - Typical Junction Capacitance

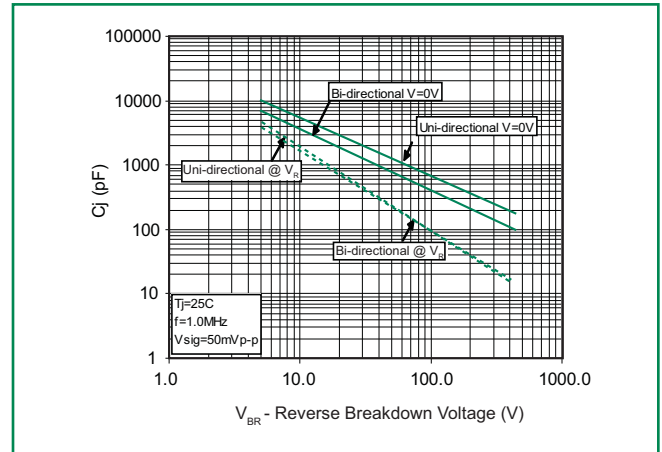

Figure 5 - Steady State Power Derating Curve

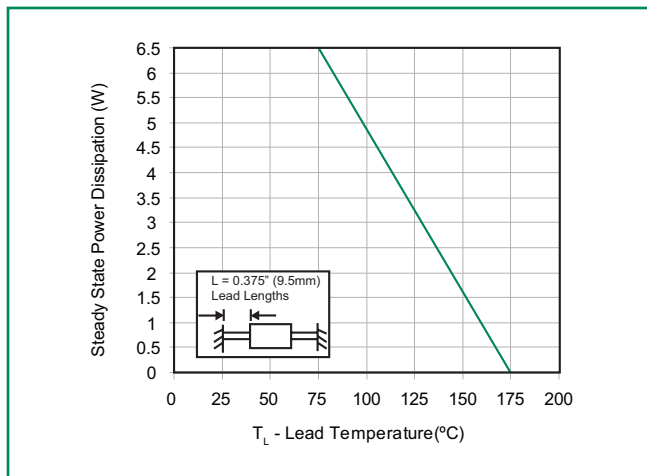
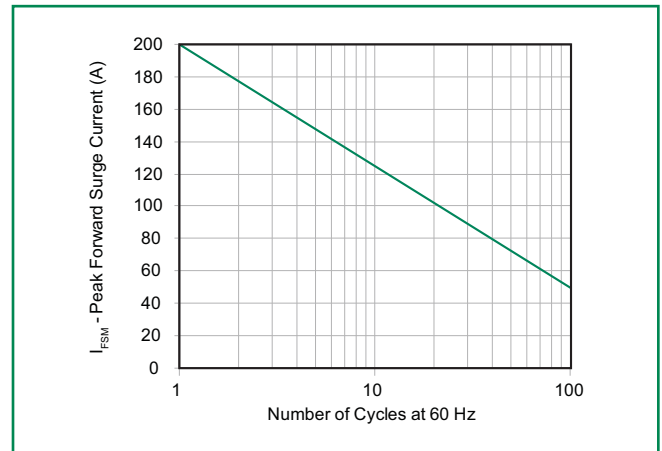
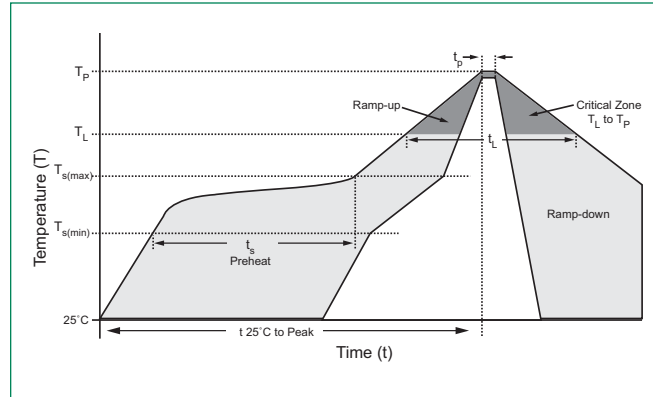

Figure 6 - Maximum Non-Repetitive Peak Forward Surge Current Uni-Directional Only



Soldering Parameters

Reflow Condition		Lead-free assembly
Pre Heat	- Temperature Min ($T_{s(min)}$)	150°C
	- Temperature Max ($T_{s(max)}$)	200°C
	- Time (min to max) (t_s)	60 – 180 secs
Average ramp up rate (Liquidus Temp (T_L) to peak)		3°C/second max
$T_{s(max)}$ to T_L - Ramp-up Rate		3°C/second max
Reflow	- Temperature (T_L) (Liquidus)	217°C
	- Time (min to max) (t_s)	60 – 150 seconds
Peak Temperature (T_p)		260 ^{+0/-5} °C
Time within 5°C of actual peak Temperature (t_p)		20 – 40 seconds
Ramp-down Rate		6°C/second max
Time 25°C to peak Temperature (T_p)		8 minutes Max.
Do not exceed		280°C



Flow/Wave Soldering (Solder Dipping)

Peak Temperature :	265°C
Dipping Time :	10 seconds
Soldering :	1 time

Physical Specifications

Weight	0.045oz., 1.2g
Case	JEDEC DO-201 molded plastic body over passivated junction.
Polarity	Color band denotes the cathode except Bipolar.
Terminal	Matte Tin axial leads, solderable per JESD22-B102D.

Environmental Specifications

Temperature Cycle	JESD22-A104
Pressure Cooker	JESD 22-A102
High Temp. Storage	JESD22-A103
HTRB	JESD22-A108
Thermal Shock	JESD22-A106

Dimensions

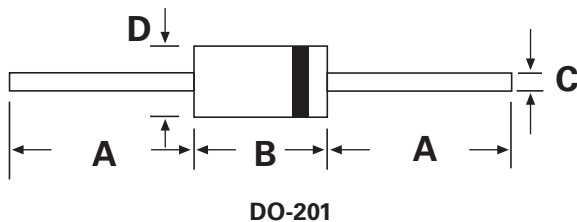

Dimensions	Inches		Millimeters	
	Min	Max	Min	Max
A	1.000	-	25.40	-
B	0.285	0.375	7.20	9.50
C	0.038	0.042	0.96	1.07
D	0.190	0.210	4.80	5.30

Part Numbering System

1.5KE xxx XXX

- OPTION CODE:**
 - BLANK** Reel Tape
 - B** Bulk Packaging
- TYPE CODE:**
 - A** Uni-Directional (5% Voltage Tolerance)
 - CA** Bi-Directional
- VOLTAGE CODE**
(Refer to the Electrical Characteristics table)
- SERIES CODE**

Part Marking System

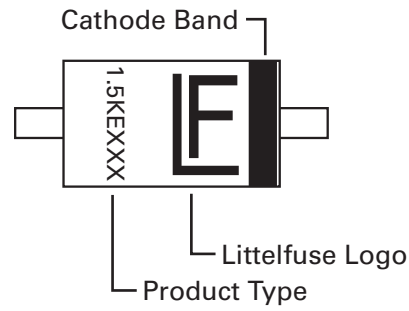

Packaging

Part Number	Component Package	Quantity	Packaging Option	Packaging Specification
1.5KExxxXX	DO-201	1200	Tape & Reel	EIA STD RS-296E
1.5KExxxXX-B	DO-201	500	BULK	Littelfuse Concord Packing Spec. DM-0016

RoHS LCE Series



Agency Approvals

AGENCY	AGENCY FILE NUMBER
	E128662/E230531

**Maximum Ratings and Thermal Characteristics
(T_A=25°C unless otherwise noted)**

Parameter	Symbol	Value	Unit
Peak Pulse Power Dissipation by 10x1000µs test waveform (Fig.1) (Note 1)	P _{PPM}	1500	W
Steady State Power Dissipation on infinite heat sink at T _L =75°C (Fig. 5)	P _D	6.5	W
Operating Junction and Storage Temperature Range	T _J , T _{STG}	-55 to 175	°C

Note:

1. Non-repetitive current pulse, per Fig. 3 and derated above T_A = 25°C per Fig. 2.

Description

The LCE Series is designed specifically to protect sensitive electronic equipment from voltage transients induced by lightning and other transient voltage events.

Features

- RoHS compliant
- Glass passivated chip junction in DO-201 Package
- 1500W peak pulse power capability at 10x1000µs waveform, repetition rate (duty cycles):0.01%
- Fast response time: typically less than 1.0ps from 0 Volts to BV min
- Excellent clamping capability
- Low incremental surge resistance
- High temperature soldering guaranteed: 260°C/40 seconds / 0.375"(9.5mm) lead length, 5 lbs., (2.3kg) tension
- Plastic package has Underwriters Laboratory Flammability classification 94V-O
- Matte Tin Lead-free plated
- Ideal for data line applications

Applications

TVS devices are ideal for the protection of I/O interfaces, V_{CC} bus and other vulnerable circuits used in telecom, computer, industrial and consumer electronic applications.

LCE Series

Electrical Characteristics

Part Number	Reverse Stand off Voltage V_R (V)	Breakdown Voltage V_{BR} (V)		Test Current I_T (mA)	Maximum Reverse Leakage I_R @ V_R (μ A)	Maximum Clamping Voltage at I_{PP} V_C (V)	Maximum Peak Pulse Current (Fig.3) I_{PPM} (A)	Maximum Junction Capacitance @ 0Volts (pF)	Working Inverse Blocking Voltage V_{WIB} (V)	Inverse Blocking Leakage Current at I_{IB} @ V_{WIB} (mA)	Peak Inverse Blocking Voltage V_{PIB} (V)	Agency Approval 
		MIN	MAX									
LCE6.5A	6.5	7.22	7.98	10	1000	11.2	100.0	100	75	1.0	100	X
LCE7.0A	7.0	7.78	8.60	10	500	12.0	100.0	100	75	1.0	100	X
LCE7.5A	7.5	8.33	9.21	10	250	12.9	100.0	100	75	1.0	100	X
LCE8.0A	8.0	8.89	9.83	1	100	13.6	100.0	100	75	1.0	100	X
LCE8.5A	8.5	9.44	10.40	1	50	14.4	100.0	100	75	1.0	100	X
LCE9.0A	9.0	10.00	11.10	1	10	15.4	97.0	100	75	1.0	100	X
LCE10A	10.0	11.10	12.30	1	5	17.0	88.0	100	75	1.0	100	X
LCE11A	11.0	12.20	13.50	1	1	18.2	82.0	100	75	1.0	100	X
LCE12A	12.0	13.30	14.70	1	1	19.9	75.0	100	75	1.0	100	X
LCE13A	13.0	14.40	15.90	1	1	21.5	70.0	100	75	1.0	100	X
LCE14A	14.0	15.60	17.20	1	1	23.2	65.0	100	75	1.0	100	X
LCE15A	15.0	16.70	18.50	1	1	24.4	61.0	100	75	1.0	100	X
LCE16A	16.0	17.80	19.70	1	1	26.0	57.0	100	75	1.0	100	X
LCE17A	17.0	18.90	20.90	1	1	27.6	54.0	100	75	1.0	100	X
LCE18A	18.0	20.00	22.10	1	1	29.2	51.0	100	75	1.0	100	X
LCE20A	20.0	22.20	24.50	1	1	32.4	46.0	100	75	1.0	100	X
LCE22A	22.0	24.40	26.90	1	1	35.5	42.0	100	75	1.0	100	X
LCE24A	24.0	26.70	29.50	1	1	38.9	39.0	100	75	1.0	100	X
LCE26A	26.0	28.90	31.90	1	1	42.1	36.0	100	75	1.0	100	X
LCE28A	28.0	31.10	34.40	1	1	45.5	33.0	100	75	1.0	100	X
LCE30A	30.0	33.30	36.80	1	1	48.4	31.0	100	75	1.0	100	
LCE33A	33.0	36.70	40.60	1	1	53.3	28.1	100	75	1.0	100	
LCE36A	36.0	40.00	44.20	1	1	58.1	25.8	100	75	1.0	100	
LCE40A	40.0	44.40	49.10	1	1	64.5	23.3	100	75	1.0	100	
LCE43A	43.0	47.80	52.80	1	1	69.4	21.6	100	75	1.0	100	
LCE45A	45.0	50.00	55.30	1	1	72.7	20.6	100	75	1.0	100	
LCE48A	48.0	53.30	58.90	1	1	77.4	19.4	100	75	1.0	100	
LCE51A	51.0	56.70	62.70	1	1	82.4	18.2	100	75	1.0	100	
LCE54A	54.0	60.00	66.30	1	1	87.1	17.2	100	100	1.0	125	
LCE58A	58.0	64.40	71.20	1	1	93.6	16.0	100	100	1.0	125	
LCE60A	60.0	66.70	73.70	1	1	96.8	15.5	100	100	1.0	125	
LCE64A	64.0	71.10	78.60	1	1	103.0	14.6	100	100	1.0	125	
LCE70A	70.0	77.80	86.00	1	1	113.0	13.3	100	125	1.0	150	
LCE75A	75.0	83.30	92.10	1	1	121.0	12.4	100	125	1.0	150	
LCE85A	85.0	94.40	104.00	1	1	129.0	11.6	100	125	1.0	150	
LCE90A	90.0	100.00	111.00	1	1	146.0	10.3	100	125	1.0	150	

Note: For parts without A, the V_{BR} is $\pm 10\%$.

Ratings and Characteristic Curves ($T_A=25^\circ\text{C}$ unless otherwise noted)

Figure 1 - Peak Pulse Power Rating

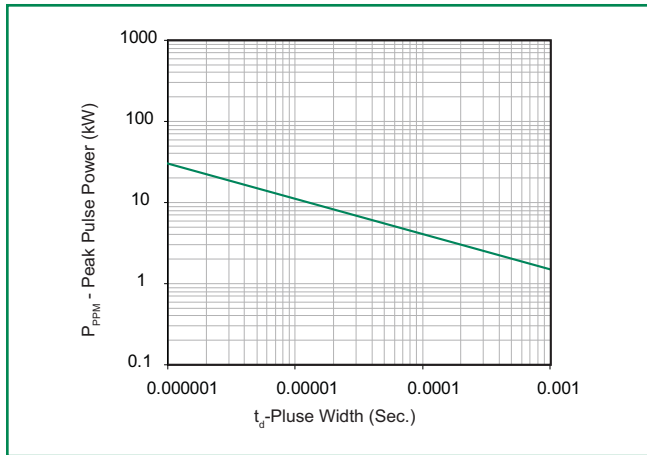

Figure 2 - Power Derating Curve

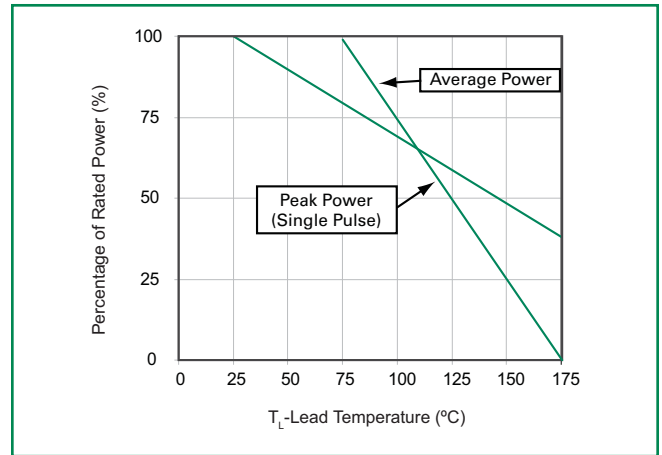

Figure 3 - Pulse Waveform

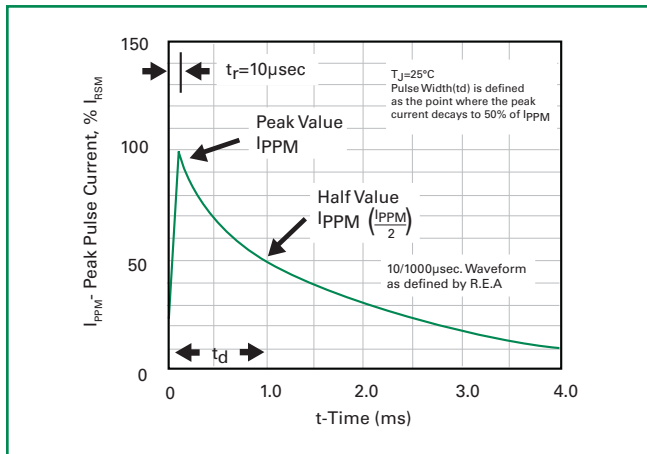

Figure 4 - AC Line Protection Application

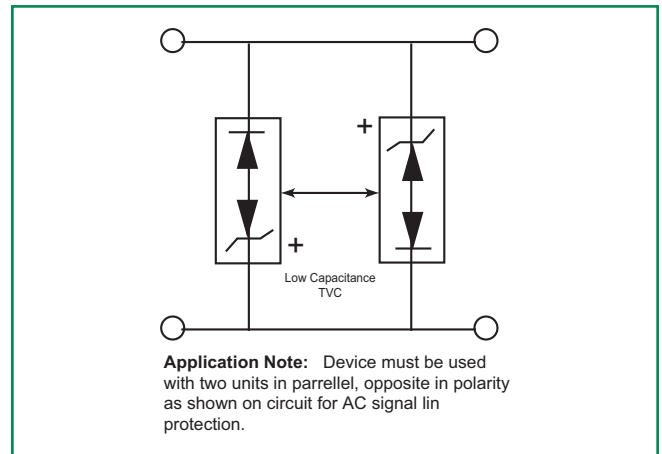
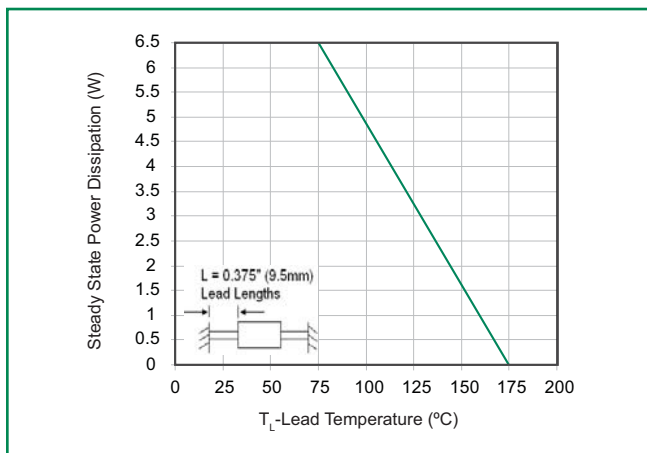
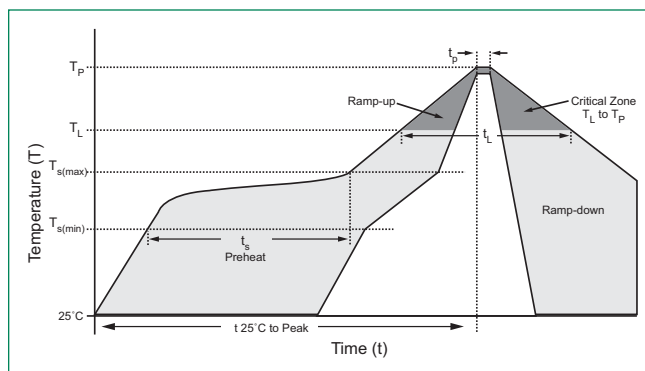

Figure 5 - Steady State Power Derating Curve



Soldering Parameters

Reflow Condition		Lead-free assembly
Pre Heat	- Temperature Min ($T_{s(min)}$)	150°C
	- Temperature Max ($T_{s(max)}$)	200°C
	- Time (min to max) (t_s)	60 – 180 secs
Average ramp up rate (Liquidus Temp (T_L) to peak)		3°C/second max
$T_{s(max)}$ to T_L - Ramp-up Rate		3°C/second max
Reflow	- Temperature (T_L) (Liquidus)	217°C
	- Time (min to max) (t_s)	60 – 150 seconds
Peak Temperature (T_p)		260 ^{+0/-5} °C
Time within 5°C of actual peak Temperature (t_p)		20 – 40 seconds
Ramp-down Rate		6°C/second max
Time 25°C to peak Temperature (T_p)		8 minutes Max.
Do not exceed		280°C



Flow/Wave Soldering (Solder Dipping)

Peak Temperature :	265°C
Dipping Time :	10 seconds
Soldering :	1 time

Physical Specifications

Weight	0.045oz., 1.2g
Case	JEDEC DO-201 molded plastic body over passivated junction.
Polarity	Color band denotes the cathode except Bipolar.
Terminal	Matte Tin axial leads, solderable per JESD22-B102D.

Environmental Specifications

Temperature Cycle	JESD22-A104
Pressure Cooker	JESD 22-A102
High Temp. Storage	JESD22-A103
HTRB	JESD22-A108
Thermal Shock	JESD22-A106

Dimensions

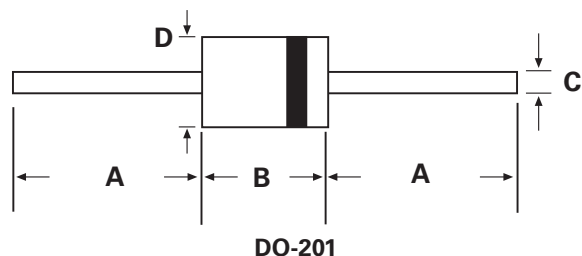

Dimensions	Inches		Millimeters	
	Min	Max	Min	Max
A	1.000	-	25.40	-
B	0.285	0.375	7.20	9.50
C	0.038	0.042	0.96	1.07
D	0.190	0.210	4.80	5.30

Part Numbering System

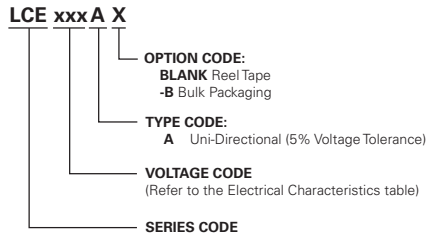

Part Marking System

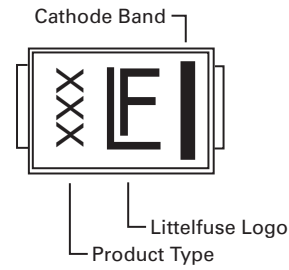

Packaging

Part Number	Component Package	Quantity	Packaging Option	Packaging Specification
LCExxxXX	DO-201	1200	Tape & Reel	EIA STD RS-296E
LCExxxXX-B	DO-201	500	BULK	Littelfuse Concord Packing Spec. DM-0016

Schematic



RoHS 3KP Series

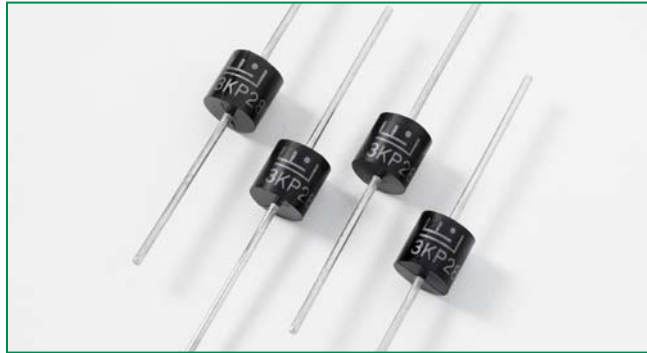

Agency Approvals

AGENCY	AGENCY FILE NUMBER
	E230531

Maximum Ratings and Thermal Characteristics
($T_A=25^\circ\text{C}$ unless otherwise noted)

Parameter	Symbol	Value	Unit
Peak Pulse Power Dissipation by 10x1000 μs test waveform (Fig.1) (Note 1)	P_{PPM}	3000	W
Steady State Power Dissipation on infinite heat sink at $T_L=75^\circ\text{C}$ (Fig. 5)	P_D	7.0	W
Peak Forward Surge Current, 8.3ms Single Half Sine Wave Unidirectional only (Note 2)	I_{FSM}	300	A
Maximum Instantaneous Forward Voltage at 100A for Unidirectional only (Note 3)	V_F	3.5/5.0	V
Operating Junction and Storage Temperature Range	T_J, T_{STG}	-55 to 175	$^\circ\text{C}$
Typical Thermal Resistance Junction to Lead	R_{JL}	8.0	$^\circ\text{C/W}$
Typical Thermal Resistance Junction to Ambient	R_{JA}	40	$^\circ\text{C/W}$

Notes:

1. Non-repetitive current pulse, per Fig. 3 and derated above $T_A = 25^\circ\text{C}$ per Fig. 2.
2. Measured on 8.3ms single half sine wave or equivalent square wave, duty cycle=4 per minute maximum.
3. $V_F < 3.5\text{V}$ for devices of $V_{BR} \leq 200\text{V}$ and $V_F < 5.0\text{V}$ for devices of $V_{BR} \geq 201\text{V}$.

Description

The 3KP Series is designed specifically to protect sensitive electronic equipment from voltage transients induced by lightning and other transient voltage events.

Features

- RoHS compliant
- Typical maximum temperature coefficient $\Delta V_{BR} = 0.1\% \times V_{BR} @ 25^\circ\text{C}$
- Glass passivated chip junction in P600 package
- 3000W peak pulse capability at 10x1000 μs waveform, repetition rate (duty cycles):0.01%
- Fast response time: typically less than 1.0ps from 0 Volts to BV min
- Excellent clamping capability
- Low incremental surge resistance
- Typical I_R less than 2 μA above 12V
- High temperature soldering guaranteed: 260 $^\circ\text{C}/40$ seconds / 0.375" (9.5mm) lead length, 5 lbs., (2.3kg) tension
- Plastic package has Underwriters Laboratory Flammability classification 94V-O
- Matte Tin Lead-free plated

Applications

TVS devices are ideal for the protection of I/O interfaces, V_{CC} bus and other vulnerable circuits used in telecom, computer, industrial and consumer electronic applications.

Transient Voltage Suppression Diodes

Axial Leaded – 3000W > 3KP series

Electrical Characteristics

Part Number (Uni)	Part Number (Bi)	Reverse Stand off Voltage V_R (Volts)	Breakdown Voltage V_{BR} (Volts) @ I_T		Test Current I_T (mA)	Maximum Clamping Voltage V_C @ I_{PP} (V)	Maximum Peak Pulse Current I_{PP} (A)	Maximum Reverse Leakage I_R @ V_R (μ A)	Agency Approval 
			MIN	MAX					
3KP5.0A	3KP5.0CA	5.0	6.40	7.00	50	9.2	326.1	5000	X
3KP6.0A	3KP6.0CA	6.0	6.67	7.37	50	10.3	291.3	5000	X
3KP6.5A	3KP6.5CA	6.5	7.22	7.98	50	11.2	267.9	2000	X
3KP7.0A	3KP7.0CA	7.0	7.78	8.60	50	12.0	250.0	1000	X
3KP7.5A	3KP7.5CA	7.5	8.33	9.21	5	12.9	232.6	250	X
3KP8.0A	3KP8.0CA	8.0	8.89	9.83	5	13.6	220.6	150	X
3KP8.5A	3KP8.5CA	8.5	9.44	10.40	5	14.4	208.3	50	X
3KP9.0A	3KP9.0CA	9.0	10.00	11.10	5	15.4	194.8	20	X
3KP10A	3KP10CA	10.0	11.10	12.30	5	17.0	176.5	15	X
3KP11A	3KP11CA	11.0	12.20	13.50	5	18.2	164.8	2	X
3KP12A	3KP12CA	12.0	13.30	14.70	5	19.9	150.8	2	X
3KP13A	3KP13CA	13.0	14.40	15.90	5	21.5	139.5	2	X
3KP14A	3KP14CA	14.0	15.60	17.20	5	23.2	129.3	2	X
3KP15A	3KP15CA	15.0	16.70	18.50	5	24.4	123.0	2	X
3KP16A	3KP16CA	16.0	17.80	19.70	5	26.0	115.4	2	X
3KP17A	3KP17CA	17.0	18.90	20.90	5	27.6	108.7	2	X
3KP18A	3KP18CA	18.0	20.00	22.10	5	29.2	102.7	2	X
3KP20A	3KP20CA	20.0	22.20	24.50	5	32.4	92.6	2	X
3KP22A	3KP22CA	22.0	24.40	26.90	5	35.5	84.5	2	X
3KP24A	3KP24CA	24.0	26.70	29.50	5	38.9	77.1	2	X
3KP26A	3KP26CA	26.0	28.90	31.90	5	42.1	71.3	2	X
3KP28A	3KP28CA	28.0	31.10	34.40	5	45.4	66.1	2	X
3KP30A	3KP30CA	30.0	33.30	36.80	5	48.4	62.0	2	X
3KP33A	3KP33CA	33.0	36.70	40.60	5	53.3	56.3	2	X
3KP36A	3KP36CA	36.0	40.00	44.20	5	58.1	51.6	2	X
3KP40A	3KP40CA	40.0	44.40	49.10	5	64.5	46.5	2	X
3KP43A	3KP43CA	43.0	47.80	52.80	5	69.4	43.2	2	X
3KP45A	3KP45CA	45.0	50.00	55.30	5	72.7	41.3	2	X
3KP48A	3KP48CA	48.0	53.30	58.90	5	77.4	38.8	2	X
3KP51A	3KP51CA	51.0	56.70	62.70	5	82.4	36.4	2	X
3KP54A	3KP54CA	54.0	60.00	66.30	5	87.1	34.4	2	X
3KP58A	3KP58CA	58.0	64.40	71.20	5	93.6	32.1	2	X
3KP60A	3KP60CA	60.0	66.70	73.70	5	96.8	31.0	2	X
3KP64A	3KP64CA	64.0	71.10	78.60	5	103.0	29.1	2	X
3KP70A	3KP70CA	70.0	77.80	86.00	5	113.0	26.5	2	X
3KP75A	3KP75CA	75.0	83.30	92.10	5	121.0	24.8	2	X
3KP78A	3KP78CA	78.0	86.70	95.80	5	126.0	23.8	2	X
3KP85A	3KP85CA	85.0	94.40	104.00	5	137.0	21.9	2	X
3KP90A	3KP90CA	90.0	100.00	111.00	5	146.0	20.5	2	X
3KP100A	3KP100CA	100.0	111.00	123.00	5	162.0	18.5	2	X
3KP110A	3KP110CA	110.0	122.00	135.00	5	177.0	16.9	2	X
3KP120A	3KP120CA	120.0	133.00	147.00	5	193.0	15.5	2	X
3KP130A	3KP130CA	130.0	144.00	159.00	5	209.0	14.4	2	X
3KP150A	3KP150CA	150.0	167.00	185.00	5	243.0	12.3	2	X
3KP160A	3KP160CA	160.0	178.00	197.00	5	259.0	11.6	2	X
3KP170A	3KP170CA	170.0	189.00	209.00	5	275.0	10.9	2	X
3KP180A	3KP180CA	180.0	200.00	221.00	5	289.0	10.4	2	X
3KP190A	3KP190CA	190.0	211.00	233.00	5	310.0	9.7	2	X
3KP200A	3KP200CA	200.0	222.00	246.00	5	329.2	9.1	2	X
3KP210A	3KP210CA	210.0	233.00	258.00	5	349.5	8.6	2	X
3KP220A	3KP220CA	220.0	244.00	270.00	5	371.1	8.1	2	X

For parts without A, the V_{BR} is $\pm 10\%$ and V_C is 5% higher than with A parts

For bidirectional type having V_R of 10 volts and less, the I_R limit is double.

Ratings and Characteristic Curves ($T_A=25^\circ\text{C}$ unless otherwise noted)

Figure 1 - Peak Pulse Power Rating Curve

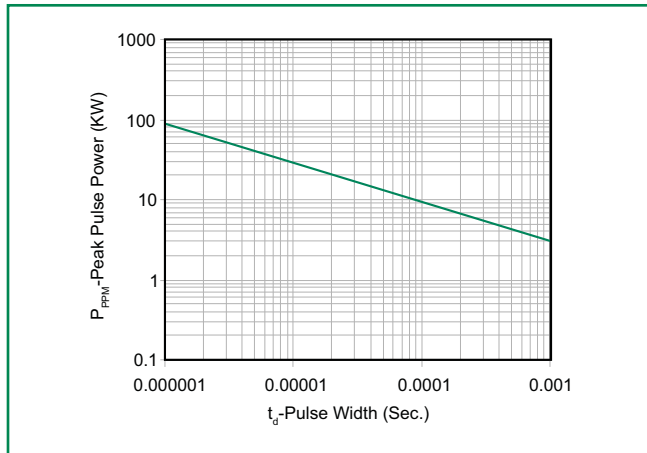

Figure 2 - Pulse Derating Curve

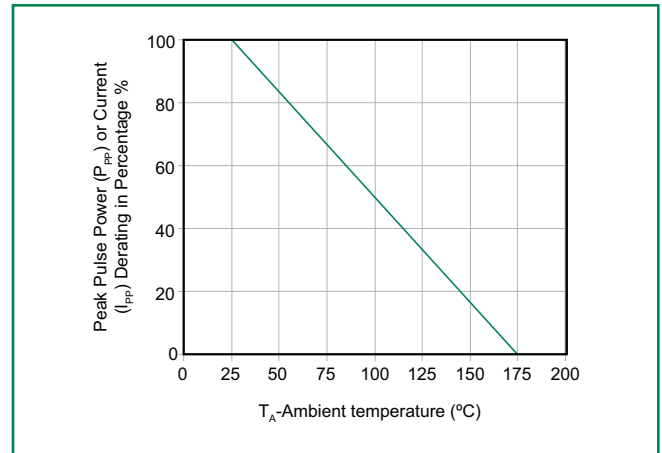

Figure 3 - Pulse Waveform

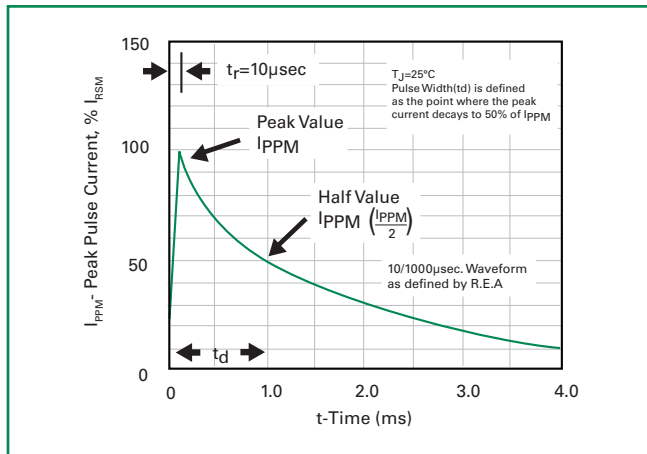

Figure 4 - Typical Junction Capacitance

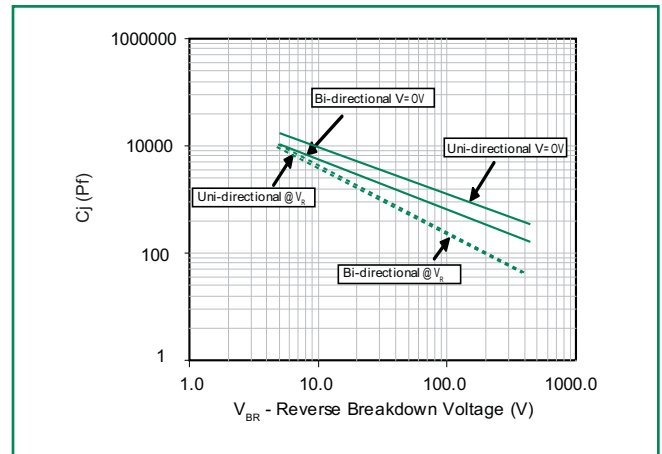

Figure 5 - Steady State Power Derating Curve

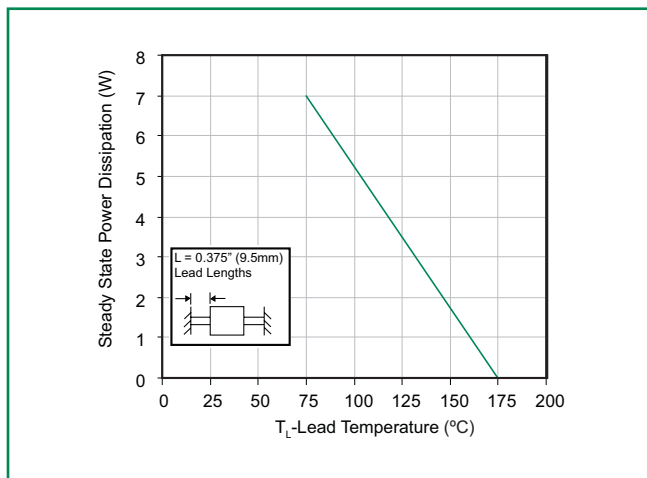
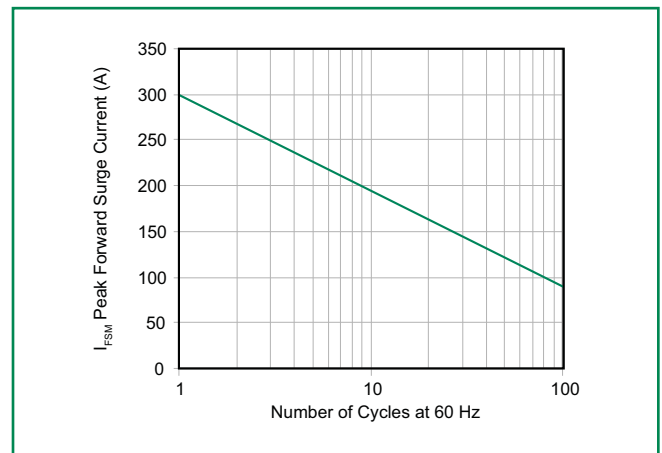
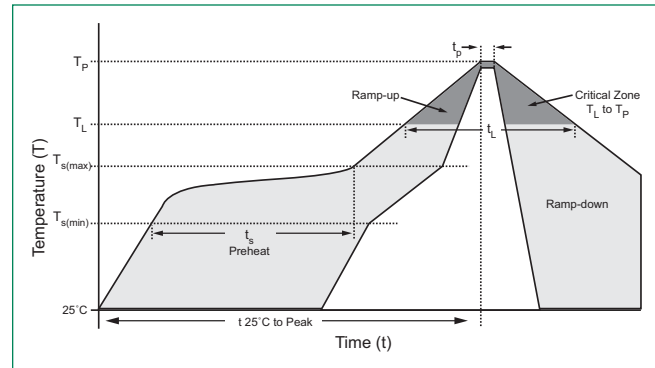

Figure 6 - Maximum Non-Repetitive Peak Forward Surge Current



Soldering Parameters

Reflow Condition		Lead-free assembly
Pre Heat	- Temperature Min ($T_{s(min)}$)	150°C
	- Temperature Max ($T_{s(max)}$)	200°C
	- Time (min to max) (t_s)	60 – 180 secs
Average ramp up rate (Liquidus Temp (T_L) to peak)		3°C/second max
$T_{s(max)}$ to T_L - Ramp-up Rate		3°C/second max
Reflow	- Temperature (T_L) (Liquidus)	217°C
	- Time (min to max) (t_s)	60 – 150 seconds
Peak Temperature (T_p)		260 ^{+0/-5} °C
Time within 5°C of actual peak Temperature (t_p)		20 – 40 seconds
Ramp-down Rate		6°C/second max
Time 25°C to peak Temperature (T_p)		8 minutes Max.
Do not exceed		280°C



Flow/Wave Soldering (Solder Dipping)

Peak Temperature :	265°C
Dipping Time :	10 seconds
Soldering :	1 time

Physical Specifications

Weight	0.07oz., 2.1g
Case	P600 molded plastic body over passivated junction.
Polarity	Color band denotes the cathode except Bipolar.
Terminal	Matte Tin axial leads, solderable per JESD22-B102D.

Environmental Specifications

Temperature Cycle	JESD22-A104
Pressure Cooker	JESD 22-A102
High Temp. Storage	JESD22-A103
HTRB	JESD22-A108
Thermal Shock	JESD22-A106

Dimensions

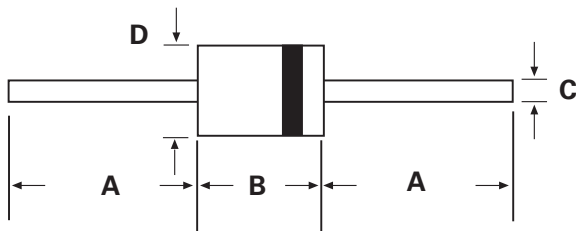

P600

Dimensions	Inches		Millimeters	
	Min	Max	Min	Max
A	1.000	-	25.40	-
B	0.340	0.360	8.60	9.10
C	0.048	0.052	1.22	1.32
D	0.340	0.360	8.60	9.10

Part Numbering System

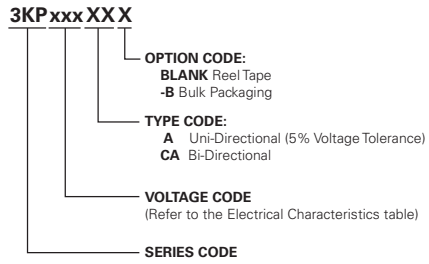

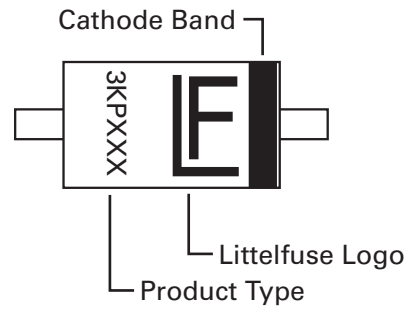

Part Marking System

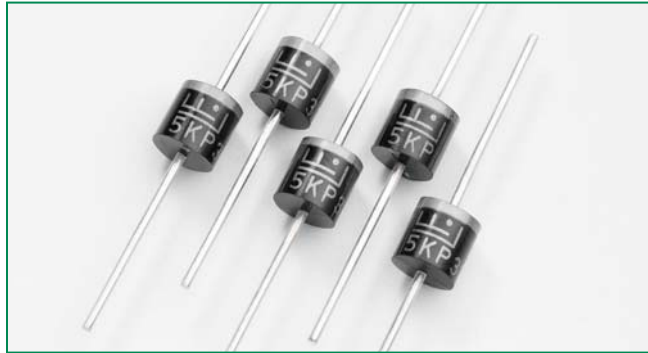

Packaging

Part Number	Component Package	Quantity	Packaging Option	Packaging Specification
3KPxxxXX	P600	800	Tape & Reel	EIA STD RS-296E
3KPxxxXX-B	P600	500	BULK	Littelfuse Concord Packing Spec. DM-0016

RoHS 5KP Series

Agency Approvals

AGENCY	AGENCY FILE NUMBER
	E128662/E230531

**Maximum Ratings and Thermal Characteristics
(T_A=25°C unless otherwise noted)**

Parameter	Symbol	Value	Unit
Peak Pulse Power Dissipation by 10x1000µs test waveform (Fig.1) (Note 1)	P _{PPM}	5000	W
Steady State Power Dissipation on infinite heat sink at T _L =75°C (Fig. 5)	P _D	8.0	W
Peak Forward Surge Current, 8.3ms Single Half Sine Wave Unidirectional only (Note 2)	I _{FSM}	400	A
Maximum Instantaneous Forward Voltage at 100A for Unidirectional only (Note 3)	V _F	3.5/5.0	V
Operating Junction and Storage Temperature Range	T _J , T _{STG}	-55 to 175	°C
Typical Thermal Resistance Junction to Lead	R _{θJL}	8.0	°C/W
Typical Thermal Resistance Junction to Ambient	R _{θJA}	40	°C/W

Notes:

1. Non-repetitive current pulse, per Fig. 3 and derated above T_A = 25°C per Fig. 2.
2. Measured on 8.3ms single half sine wave or equivalent square wave, duty cycle=4 per minute maximum.
3. V_F<3.5V for devices of V_{BR} ≤ 200V and V_F<5.0V for devices of V_{BR} ≥ 201V.

Description

The 5KP Series is designed specifically to protect sensitive electronic equipment from voltage transients induced by lightning and other transient voltage events.

Features

- RoHS compliant
- Typical maximum temperature coefficient $\Delta V_{BR} = 0.1\% \times V_{BR} @ 25^\circ\text{C}$
- Glass passivated chip junction in P600 package
- 5000W peak pulse capability at 10x1000µs waveform, repetition rate (duty cycles):0.01%
- Fast response time: typically less than 1.0ps from 0 Volts to BV min
- Excellent clamping capability
- Low incremental surge resistance
- Typical I_R less than 2µA above 12V
- High temperature soldering guaranteed: 260°C/40 seconds / 0.375" (9.5mm) lead length, 5 lbs., (2.3kg) tension
- Plastic package has Underwriters Laboratory Flammability classification 94V-O
- Matte Tin Lead-free plated

Applications

TVS devices are ideal for the protection of I/O interfaces, V_{CC} bus and other vulnerable circuits used in telecom, computer, industrial and consumer electronic applications.

Transient Voltage Suppression Diodes

Axial Leaded – 5000W > 5KP series

Electrical Characteristics

Part Number (Uni)	Part Number (Bi)	Reverse Stand off Voltage V_R (Volts)	Breakdown Voltage V_{BR} (Volts) @ I_T		Test Current I_T (mA)	Maximum Clamping Voltage V_C @ I_{PP} (V)	Maximum Peak Pulse Current I_{PP} (A)	Maximum Reverse Leakage I_R @ V_R (μ A)	Agency Approval 
			MIN	MAX					
5KP5.0A	5KP5.0CA	5.0	6.40	7.00	50	9.2	554.3	5000	X
5KP6.0A	5KP6.0CA	6.0	6.67	7.37	50	10.3	495.1	5000	X
5KP6.5A	5KP6.5CA	6.5	7.22	7.98	50	11.2	455.4	2000	X
5KP7.0A	5KP7.0CA	7.0	7.78	8.60	50	12.0	425.0	1000	X
5KP7.5A	5KP7.5CA	7.5	8.33	9.21	5	12.9	395.3	250	X
5KP8.0A	5KP8.0CA	8.0	8.89	9.83	5	13.6	375.0	150	X
5KP8.5A	5KP8.5CA	8.5	9.44	10.40	5	14.4	354.2	50	X
5KP9.0A	5KP9.0CA	9.0	10.00	11.10	5	15.4	331.2	20	X
5KP10A	5KP10CA	10.0	11.10	12.30	5	17.0	300.0	15	X
5KP11A	5KP11CA	11.0	12.20	13.50	5	18.2	280.2	2	X
5KP12A	5KP12CA	12.0	13.30	14.70	5	19.9	256.3	2	X
5KP13A	5KP13CA	13.0	14.40	15.90	5	21.5	237.2	2	X
5KP14A	5KP14CA	14.0	15.60	17.20	5	23.2	219.8	2	X
5KP15A	5KP15CA	15.0	16.70	18.50	5	24.4	209.0	2	X
5KP16A	5KP16CA	16.0	17.80	19.70	5	26.0	196.2	2	X
5KP17A	5KP17CA	17.0	18.90	20.90	5	27.6	184.8	2	X
5KP18A	5KP18CA	18.0	20.00	22.10	5	29.2	174.7	2	X
5KP20A	5KP20CA	20.0	22.20	24.50	5	32.4	157.4	2	X
5KP22A	5KP22CA	22.0	24.00	26.90	5	35.5	143.7	2	X
5KP24A	5KP24CA	24.0	26.70	29.50	5	38.9	131.1	2	X
5KP26A	5KP26CA	26.0	28.90	31.90	5	42.1	121.1	2	X
5KP28A	5KP28CA	28.0	31.10	34.40	5	45.4	112.3	2	X
5KP30A	5KP30CA	30.0	33.30	36.80	5	48.4	105.4	2	X
5KP33A	5KP33CA	33.0	36.70	40.60	5	53.3	95.7	2	X
5KP36A	5KP36CA	36.0	40.00	44.20	5	58.1	87.8	2	X
5KP40A	5KP40CA	40.0	44.40	49.10	5	64.5	79.1	2	X
5KP43A	5KP43CA	43.0	47.80	52.80	5	69.4	73.5	2	X
5KP45A	5KP45CA	45.0	50.00	55.30	5	72.7	70.2	2	X
5KP48A	5KP48CA	48.0	53.30	58.90	5	77.4	65.9	2	X
5KP51A	5KP51CA	51.0	56.70	62.70	5	82.4	61.9	2	X
5KP54A	5KP54CA	54.0	60.00	66.30	5	87.1	58.6	2	X
5KP58A	5KP58CA	58.0	64.40	71.20	5	93.6	54.5	2	X
5KP60A	5KP60CA	60.0	66.70	73.70	5	96.8	52.7	2	X
5KP64A	5KP64CA	64.0	71.10	78.60	5	103.0	49.5	2	X
5KP70A	5KP70CA	70.0	77.80	86.00	5	113.0	45.1	2	X
5KP75A	5KP75CA	75.0	83.30	92.10	5	121.0	42.1	2	X
5KP78A	5KP78CA	78.0	86.70	95.80	5	126.0	40.5	2	X
5KP85A	5KP85CA	85.0	94.40	104.00	5	137.0	37.2	2	X
5KP90A	5KP90CA	90.0	100.00	111.00	5	146.0	34.9	2	X
5KP100A	5KP100CA	100.0	110.00	123.00	5	162.0	31.5	2	X
5KP110A	5KP110CA	110.0	122.00	135.00	5	177.0	28.8	2	X
5KP120A	5KP120CA	120.0	133.00	147.00	5	193.0	26.4	2	X
5KP130A	5KP130CA	130.0	144.00	159.00	5	209.0	24.4	2	X
5KP150A	5KP150CA	150.0	167.00	185.00	5	243.0	21.0	2	X
5KP160A	5KP160CA	160.0	178.00	197.00	5	259.0	19.7	2	X
5KP170A	5KP170CA	170.0	189.00	209.00	5	275.0	18.5	2	X
5KP180A	5KP180CA	180.0	200.00	221.00	5	292.0	17.5	2	X
5KP190A	5KP190CA	190.0	211.00	233.00	5	310.0	16.5	2	X
5KP200A	5KP200CA	200.0	222.00	246.00	5	329.2	15.5	2	X
5KP210A	5KP210CA	210.0	233.00	258.00	5	349.5	14.6	2	X
5KP220A	5KP220CA	220.0	244.00	270.00	5	371.1	13.7	2	X
5KP250A	5KP250CA	250.0	277.00	306.00	5	425.0	12.0	2	X

For bidirectional type having V_R of 10 volts and less, the I_R limit is double.

For parts without A, the V_{BR} is $\pm 10\%$ and V_C is 5% higher than with A parts

Ratings and Characteristic Curves ($T_A=25^\circ\text{C}$ unless otherwise noted)

Figure 1 - Peak Pulse Power Rating Curve

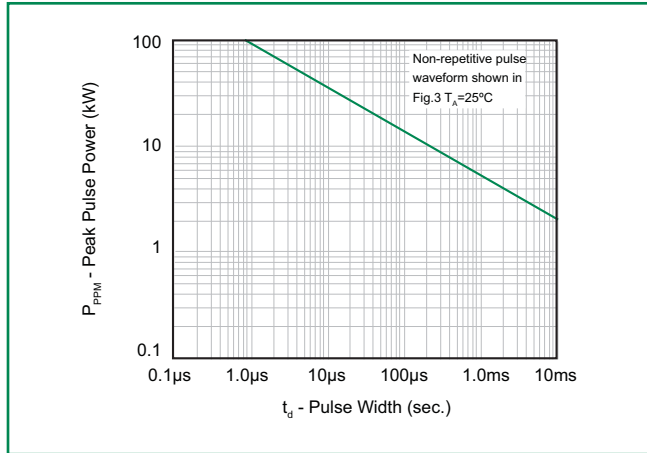

Figure 2 - Pulse Derating Curve

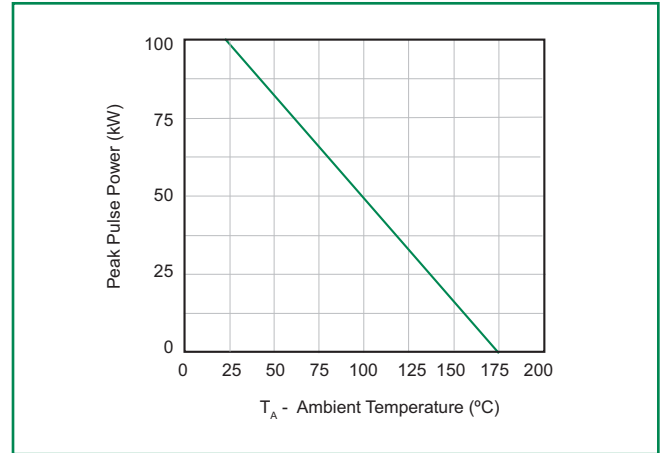

Figure 3 - Pulse Waveform

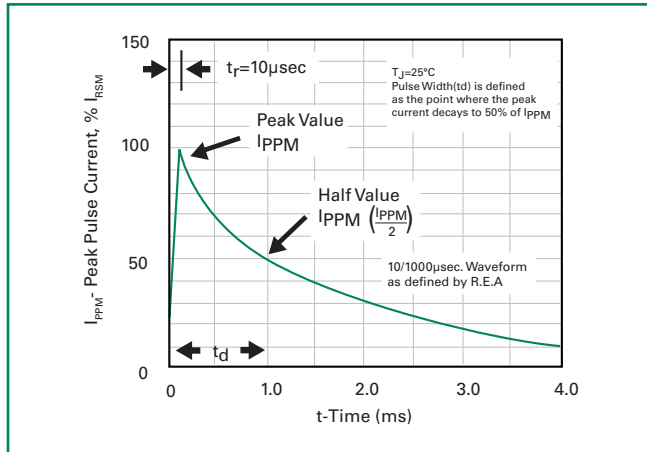

Figure 4 - Typical Junction Capacitance

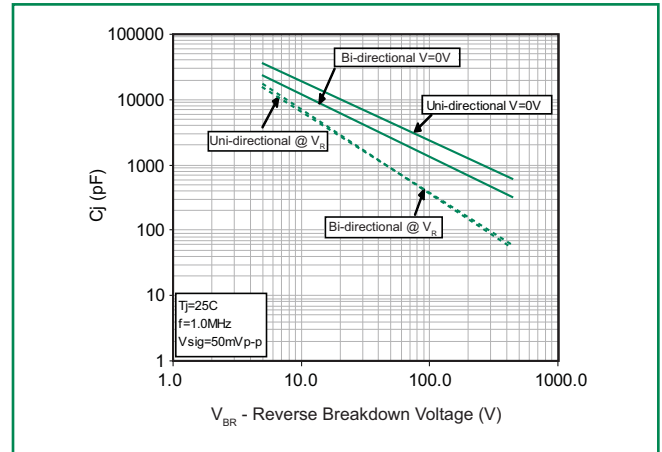

Figure 5 - Steady State Power Derating Curve

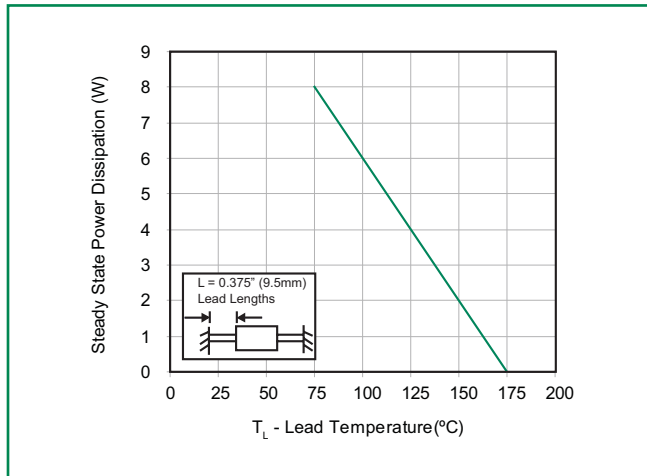
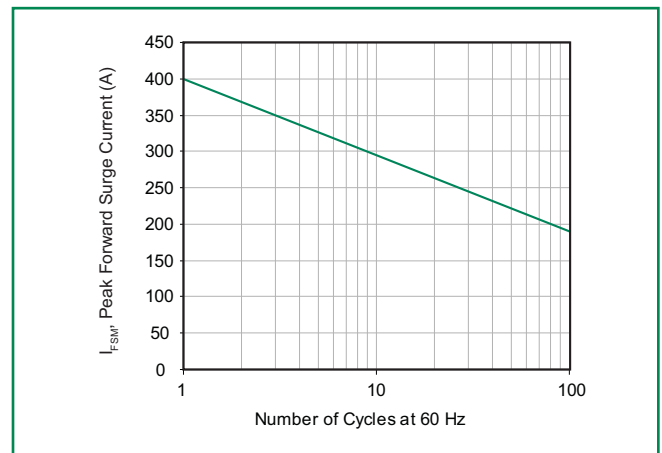
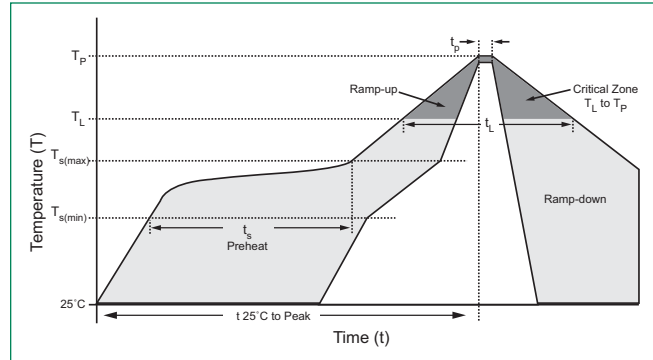

Figure 6 - Maximum Non-Repetitive Peak Forward Surge Current



Soldering Parameters

Reflow Condition		Lead-free assembly
Pre Heat	- Temperature Min ($T_{s(min)}$)	150°C
	- Temperature Max ($T_{s(max)}$)	200°C
	- Time (min to max) (t_s)	60 – 180 secs
Average ramp up rate (Liquidus Temp (T_L) to peak)		3°C/second max
$T_{s(max)}$ to T_L - Ramp-up Rate		3°C/second max
Reflow	- Temperature (T_L) (Liquidus)	217°C
	- Time (min to max) (t_s)	60 – 150 seconds
Peak Temperature (T_p)		260 ^{+0/-5} °C
Time within 5°C of actual peak Temperature (t_p)		20 – 40 seconds
Ramp-down Rate		6°C/second max
Time 25°C to peak Temperature (T_p)		8 minutes Max.
Do not exceed		280°C



Flow/Wave Soldering (Solder Dipping)

Peak Temperature :	265°C
Dipping Time :	10 seconds
Soldering :	1 time

Physical Specifications

Weight	0.07oz., 2.1g
Case	P600 molded plastic body over passivated junction.
Polarity	Color band denotes the cathode except Bipolar.
Terminal	Matte Tin axial leads, solderable per JESD22-B102D.

Environmental Specifications

Temperature Cycle	JESD22-A104
Pressure Cooker	JESD 22-A102
High Temp. Storage	JESD22-A103
HTRB	JESD22-A108
Thermal Shock	JESD22-A106

Dimensions

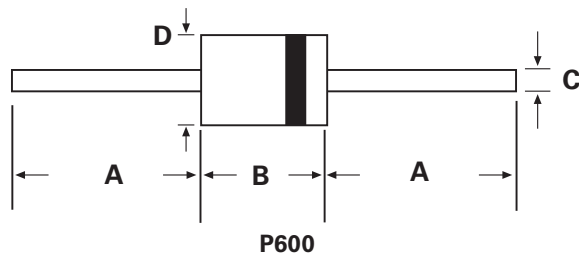

Dimensions	Inches		Millimeters	
	Min	Max	Min	Max
A	1.000	-	25.40	-
B	0.340	0.360	8.60	9.10
C	0.048	0.052	1.22	1.32
D	0.340	0.360	8.60	9.10

Part Numbering System

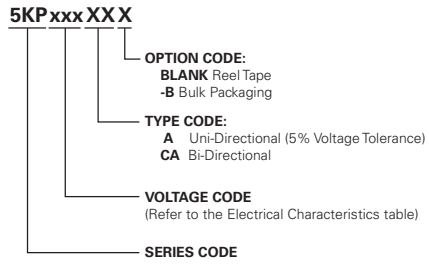

Part Marking System

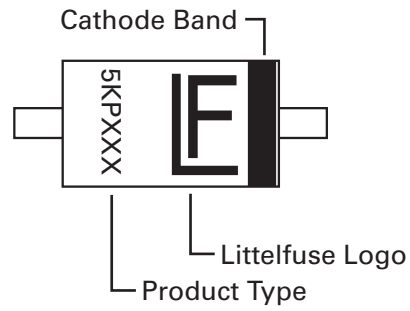

Packaging

Part Number	Component Package	Quantity	Packaging Option	Packaging Specification
5KPxxxXX	P600	800	Tape & Reel	EIA STD RS-296E
5KPxxxXX-B	P600	500	BULK	Littelfuse Concord Packing Spec. DM-0016

RoHS 15KPA Series



Description

The 15KPA Series is designed specifically to protect sensitive electronic equipment from voltage transients induced by lightning and other transient voltage events.

Features

- RoHS compliant
- Typical maximum temperature coefficient $\Delta V_{BR} = 0.1\% \times V_{BR} @ 25^\circ\text{C}$
- Glass passivated chip junction in P600 package
- 15000W peak pulse capability at 10x1000µs waveform, repetition rate (duty cycles):0.01%
- Fast response time: typically less than 1.0ps from 0 Volts to BV min
- Excellent clamping capability
- Low incremental surge resistance
- Typical I_R less than 2µA above 36V
- High temperature soldering guaranteed: 260°C/40 seconds / 0.375" (9.5mm) lead length, 5 lbs., (2.3kg) tension
- Plastic package has Underwriters Laboratory Flammability classification 94V-0
- Matte Tin Lead-free plated

Agency Approvals

AGENCY	AGENCY FILE NUMBER
	E128662/E230531

Maximum Ratings and Thermal Characteristics (T_A=25°C unless otherwise noted)

Parameter	Symbol	Value	Unit
Peak Pulse Power Dissipation by 10x1000µs test waveform (Fig.1) (Note 1)	P _{PPM}	15000	W
Steady State Power Dissipation on infinite heat sink at T _L =75°C (Fig. 5)	P _D	8.0	W
Peak Forward Surge Current, 8.3ms Single Half Sine Wave Unidirectional only (Note 2)	I _{FSM}	400	A
Operating Junction and Storage Temperature Range	T _J , T _{STG}	-55 to 175	°C
Typical Thermal Resistance Junction to Lead	R _{θJL}	8.0	°C/W
Typical Thermal Resistance Junction to Ambient	R _{θJA}	40	°C/W

Notes:

1. Non-repetitive current pulse, per Fig. 3 and derated above T_A = 25°C per Fig. 2.
2. Measured on 8.3ms single half sine wave or equivalent square wave, duty cycle=4 per minute maximum.

Applications

TVS devices are ideal for the protection of I/O interfaces, V_{CC} bus and other vulnerable circuits used in telecom, computer, industrial and consumer electronic applications.

15KPA Series

Electrical Characteristics

Part Number (Uni)	Part Number (Bi)	Reverse Stand off Voltage V_R (Volts)	Breakdown Voltage V_{BR} (Volts) @ I_T	Test Current I_T (mA)	Maximum Peak Pulse Current I_{PP} (A)	Maximum Reverse Leakage I_R @ V_R (μ A)	Maximum Clamping Voltage V_C @ I_{PP} (V)	Agency Approval 
			MIN					
15KPA17A	15KPA17CA	17	18.99	50	515.4	5000	29.3	X
15KPA18A	15KPA18CA	18	20.11	50	488.7	5000	30.9	X
15KPA20A	15KPA20CA	20	22.34	20	440.2	1500	34.3	X
15KPA22A	15KPA22CA	22	24.57	10	407.0	500	37.1	X
15KPA24A	15KPA24CA	24	26.81	5	371.0	150	40.7	X
15KPA26A	15KPA26CA	26	29.04	5	343.2	50	44.0	X
15KPA28A	15KPA28CA	28	31.28	5	317.9	25	47.5	X
15KPA30A	15KPA30CA	30	33.51	5	297.8	15	50.7	X
15KPA33A	15KPA33CA	33	36.90	5	276.1	2	54.7	X
15KPA36A	15KPA36CA	36	40.20	5	252.5	2	59.8	X
15KPA40A	15KPA40CA	40	44.70	5	229.5	2	65.8	X
15KPA43A	15KPA43CA	43	48.00	5	216.3	2	69.8	X
15KPA45A	15KPA45CA	45	50.30	5	207.4	2	72.8	X
15KPA48A	15KPA48CA	48	53.60	5	194.3	2	77.7	X
15KPA51A	15KPA51CA	51	57.00	5	182.1	2	82.9	X
15KPA54A	15KPA54CA	54	60.30	5	172.2	2	87.7	X
15KPA58A	15KPA58CA	58	64.80	5	161.0	2	93.8	X
15KPA60A	15KPA60CA	60	67.00	5	155.0	2	97.4	X
15KPA64A	15KPA64CA	64	71.50	5	144.9	2	104.2	X
15KPA70A	15KPA70CA	70	78.20	5	132.9	2	113.6	X
15KPA75A	15KPA75CA	75	83.80	5	123.8	2	122.0	X
15KPA78A	15KPA78CA	78	87.10	5	119.7	2	126.1	X
15KPA85A	15KPA85CA	85	94.90	5	109.7	2	137.6	X
15KPA90A	15KPA90CA	90	100.50	5	103.7	2	145.6	X
15KPA100A	15KPA100CA	100	111.70	5	93.6	2	161.3	X
15KPA110A	15KPA110CA	110	122.90	5	84.5	2	178.6	X
15KPA120A	15KPA120CA	120	134.00	5	78.5	2	192.3	X
15KPA130A	15KPA130CA	130	145.20	5	72.5	2	208.3	X
15KPA150A	15KPA150CA	150	167.60	5	62.4	2	241.9	X
15KPA160A	15KPA160CA	160	178.70	5	58.4	2	258.6	X
15KPA170A	15KPA170CA	170	189.90	5	55.4	2	272.7	X
15KPA180A	15KPA180CA	180	201.10	5	52.3	2	288.5	X
15KPA200A	15KPA200CA	200	223.40	5	47.3	2	319.1	X
15KPA220A	15KPA220CA	220	245.70	5	35.2	2	428.6	X
15KPA240A	15KPA240CA	240	268.10	5	39.3	2	384.6	X
15KPA260A	15KPA260CA	260	290.40	5	36.2	2	416.7	X
15KPA280A	15KPA280CA	280	312.80	5	33.2	2	454.5	X

For bidirectional type having V_R of 30 volts and less, the I_R limit is double.

For parts without A, the V_{BR} is $\pm 10\%$ and V_C is 5% higher than with A parts

Ratings and Characteristic Curves ($T_A=25^\circ\text{C}$ unless otherwise noted)

Figure 1 - Peak Pulse Power Rating Curve

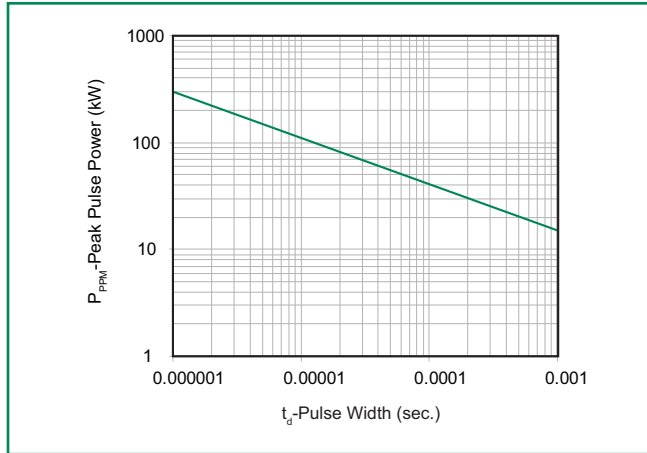

Figure 2 - Pulse Derating Curve

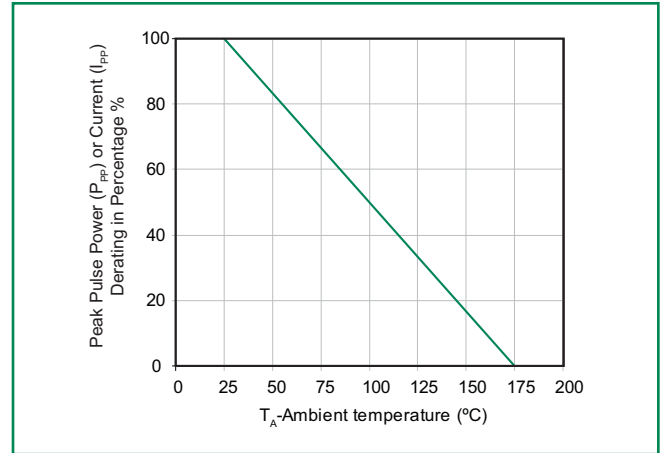

Figure 3 - Test Pulse Waveform

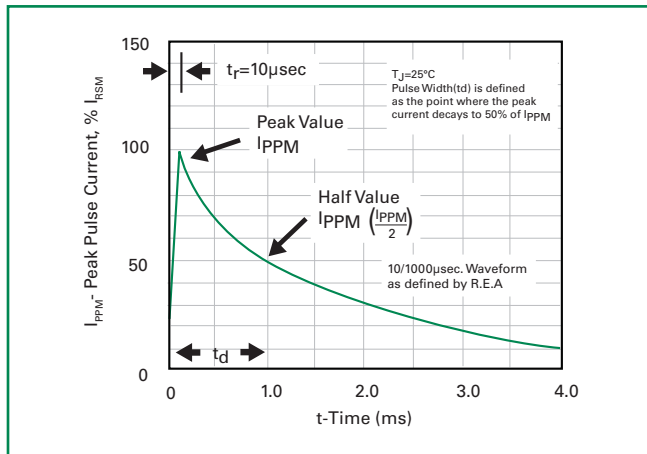

Figure 4 - Typical Junction Capacitance

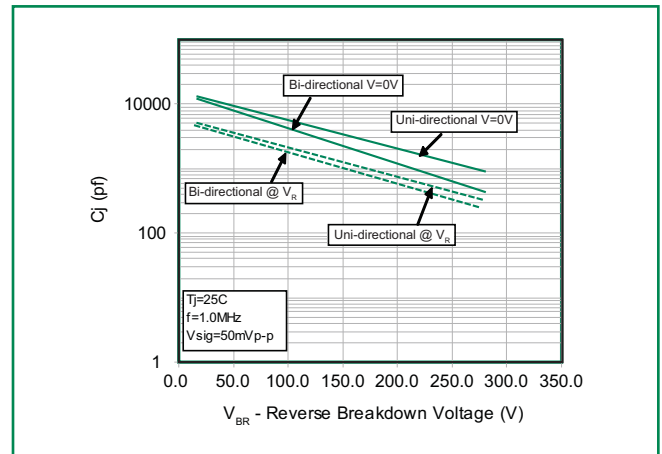

Figure 5 - Steady State Power Derating Curve

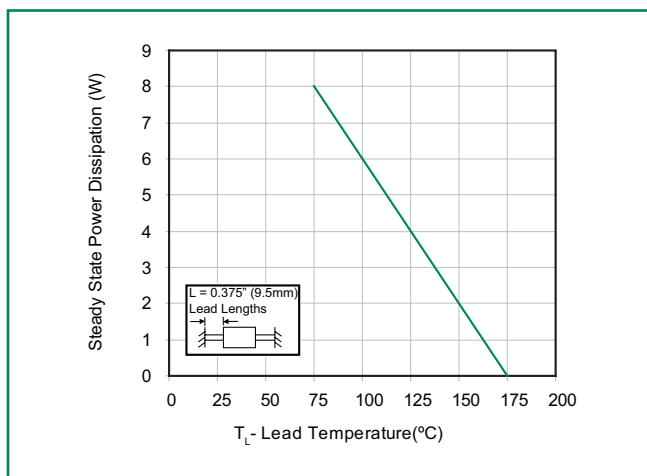
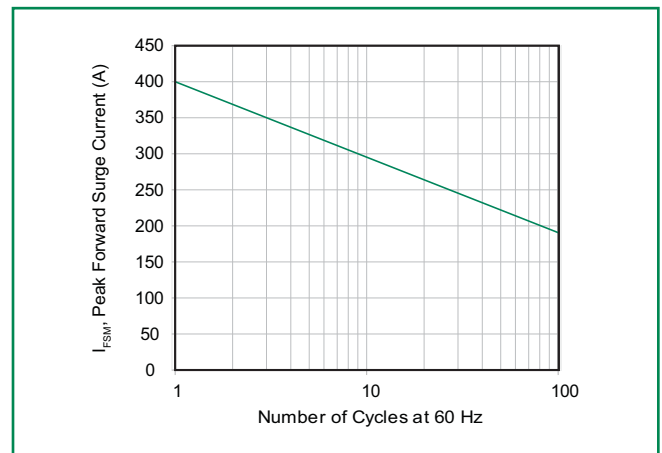
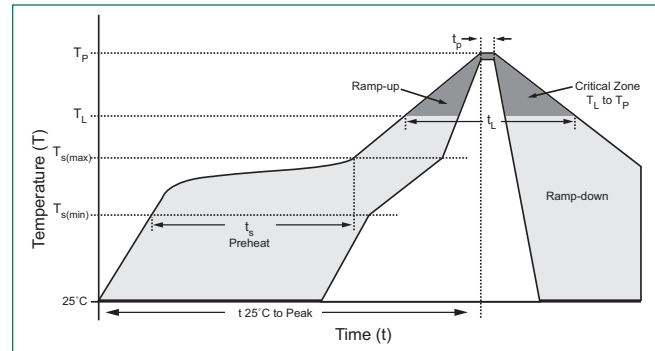

Figure 6 - Maximum Non-Repetitive Forward Surge Current



Soldering Parameters

Reflow Condition		Lead-free assembly
Pre Heat	- Temperature Min ($T_{s(min)}$)	150°C
	- Temperature Max ($T_{s(max)}$)	200°C
	- Time (min to max) (t_s)	60 – 180 secs
Average ramp up rate (Liquidus Temp (T_L) to peak)		3°C/second max
$T_{s(max)}$ to T_L - Ramp-up Rate		3°C/second max
Reflow	- Temperature (T_L) (Liquidus)	217°C
	- Time (min to max) (t_s)	60 – 150 seconds
Peak Temperature (T_p)		260 ^{+0/-5} °C
Time within 5°C of actual peak Temperature (t_p)		20 – 40 seconds
Ramp-down Rate		6°C/second max
Time 25°C to peak Temperature (T_p)		8 minutes Max.
Do not exceed		280°C



Flow/Wave Soldering (Solder Dipping)

Peak Temperature :	265°C
Dipping Time :	10 seconds
Soldering :	1 time

Physical Specifications

Weight	0.07oz., 2.5g
Case	P600 molded plastic body over passivated junction.
Polarity	Color band denotes the cathode except Bipolar.
Terminal	Matte Tin axial leads, solderable per JESD22-B102D.

Environmental Specifications

Temperature Cycle	JESD22-A104
Pressure Cooker	JESD 22-A102
High Temp. Storage	JESD22-A103
HTRB	JESD22-A108
Thermal Shock	JESD22-A106

Dimensions

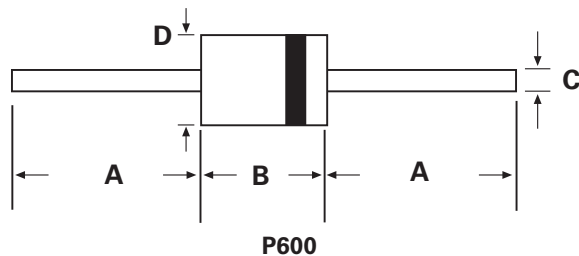

Dimensions	Inches		Millimeters	
	Min	Max	Min	Max
A	1.000	-	25.40	-
B	0.340	0.360	8.60	9.10
C	0.048	0.052	1.22	1.32
D	0.340	0.360	8.60	9.10

Part Numbering System

15KPA xxx XX X

OPTION CODE:

- BLANK** Reel Tape
- B** Bulk Packaging

TYPE CODE:

- A** Uni-Directional (5% Voltage Tolerance)
- CA** Bi-Directional

VOLTAGE CODE

(Refer to the Electrical Characteristics table)

SERIES CODE

Part Marking System

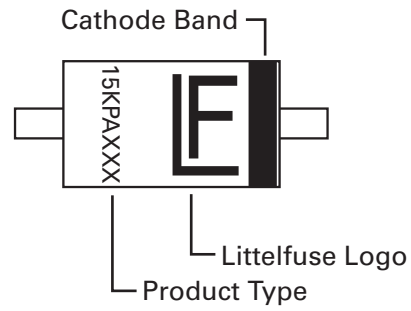

Packaging

Part Number	Component Package	Quantity	Packaging Option	Packaging Specification
15KPAxxxXX	P600	800	Tape & Reel	EIA STD RS-296E
15KPAxxxXX-B	P600	500	BULK	Littelfuse Concord Packing Spec. DM-0016

RoHS 20KPA Series



Agency Approvals

AGENCY	AGENCY FILE NUMBER
	E230531

**Maximum Ratings and Thermal Characteristics
(T_A=25°C unless otherwise noted)**

Parameter	Symbol	Value	Unit
Peak Pulse Power Dissipation by 10x1000µs test waveform (Fig.1) (Note 1)	P _{PPM}	20000	W
Steady State Power Dissipation on infinite heat sink at T _L =75°C (Fig. 5)	P _D	8.0	W
Peak Forward Surge Current, 8.3ms Single Half Sine Wave Unidirectional only (Note 2)	I _{FSM}	400	A
Operating Junction and Storage Temperature Range	T _J , T _{STG}	-55 to 175	°C
Typical Thermal Resistance Junction to Lead	R _{θJL}	8.0	°C/W
Typical Thermal Resistance Junction to Ambient	R _{θJA}	40	°C/W

Notes:

1. Non-repetitive current pulse, per Fig. 3 and derated above T_A = 25°C per Fig. 2.
2. Measured on 8.3ms single half sine wave or equivalent square wave, duty cycle=4 per minute maximum.

Description

The 20KPA Series is designed specifically to protect sensitive electronic equipment from voltage transients induced by lightning and other transient voltage events.

Features

- RoHS compliant
- Typical maximum temperature coefficient $\Delta V = 0.1\% \times V_{BR}$ @25°C
- Glass passivated chip junction in P600 package
- 20000W peak pulse capability at 10x1000µs waveform, repetition rate (duty cycles):0.01%
- Fast response time: typically less than 1.0ps from 0 Volts to BV min
- Excellent clamping capability
- Low incremental surge resistance
- Typical I_R less than 2µA above 49V
- High temperature soldering guaranteed: 260°C/40 seconds / 0.375"(9.5mm) lead length, 5 lbs., (2.3kg) tension
- Plastic package has Underwriters Laboratory Flammability classification 94V-0
- Matte Tin Lead-free plated

Applications

TVS devices are ideal for the protection of I/O interfaces, V_{CC} bus and other vulnerable circuits used in telecom, computer, industrial and consumer electronic applications.

20KPA Series

Electrical Characteristics

Part Number (Uni)	Part Number (Bi)	Reverse Stand off Voltage V_R (Volts)	Breakdown Voltage V_{BR} (Volts) @ I_T	Test Current I_T (mA)	Maximum Peak Pulse Current I_{PP} (A)	Maximum Reverse Leakage I_R @ V_R (μ A)	Maximum Clamping Voltage V_C @ I_{PP} (V)	Agency Approval 
			MIN					
20KPA20A	20KPA20CA	20	22.34	50	548.9	5000	36.8	X
20KPA24A	20KPA24CA	24	26.81	50	490.3	5000	41.2	X
20KPA26A	20KPA26CA	26	29.04	50	451.9	2000	44.7	X
20KPA28A	20KPA28CA	28	31.28	50	420.8	1000	48.0	X
20KPA30A	20KPA30CA	30	33.51	5	392.2	250	51.5	X
20KPA32A	20KPA32CA	32	35.74	5	372.0	150	54.3	X
20KPA34A	20KPA34CA	34	38.00	5	351.3	50	57.5	X
20KPA36A	20KPA36CA	36	40.20	5	328.5	20	61.5	X
20KPA40A	20KPA40CA	40	44.70	5	297.9	15	67.8	X
20KPA44A	20KPA44CA	44	49.10	5	277.9	2	72.7	X
20KPA48A	20KPA48CA	48	53.60	5	254.4	2	79.4	X
20KPA52A	20KPA52CA	52	58.10	5	235.4	2	85.8	X
20KPA56A	20KPA56CA	56	62.60	5	218.1	2	92.6	X
20KPA60A	20KPA60CA	60	67.00	5	207.0	2	97.6	X
20KPA64A	20KPA64CA	64	71.50	5	194.2	2	104.0	X
20KPA68A	20KPA68CA	68	76.00	5	183.6	2	110.0	X
20KPA72A	20KPA72CA	72	80.40	5	174.1	2	116.0	X
20KPA80A	20KPA80CA	80	89.40	5	155.4	2	130.0	X
20KPA88A	20KPA88CA	88	98.30	5	142.3	2	142.0	X
20KPA96A	20KPA96CA	96	107.20	5	130.3	2	155.0	X
20KPA104A	20KPA104CA	104	116.20	5	120.2	2	168.0	X
20KPA112A	20KPA112CA	112	125.10	5	111.0	2	182.0	X
20KPA120A	20KPA120CA	120	134.00	5	104.1	2	194.0	X
20KPA132A	20KPA132CA	132	147.40	5	94.8	2	213.0	X
20KPA144A	20KPA144CA	144	160.80	5	87.1	2	232.0	X
20KPA160A	20KPA160CA	160	178.70	5	78.3	2	258.0	X
20KPA172A	20KPA172CA	172	192.10	5	72.9	2	277.0	X
20KPA180A	20KPA180CA	180	201.10	5	69.4	2	291.0	X
20KPA192A	20KPA192CA	192	214.50	5	65.4	2	309.0	X
20KPA204A	20KPA204CA	204	227.90	5	61.4	2	329.0	X
20KPA216A	20KPA216CA	216	241.30	5	58.0	2	348.0	X
20KPA232A	20KPA232CA	232	259.10	5	54.0	2	374.0	X
20KPA240A	20KPA240CA	240	268.10	5	52.2	2	387.0	X
20KPA256A	20KPA256CA	256	286.00	5	49.0	2	412.0	X
20KPA280A	20KPA280CA	280	312.80	5	44.8	2	451.0	X
20KPA300A	20KPA300CA	300	335.10	5	41.8	2	483.0	X

For bidirectional type having V_{RWM} of 40 volts and less, the I_R limit is double.

For parts without A, the V_{BR} is $\pm 10\%$ and V_C is 5% higher than with A parts.

Ratings and Characteristic Curves ($T_A=25^\circ\text{C}$ unless otherwise noted) **Figure 1 - Peak Pulse Power Rating Curve**

Figure 1 - Peak Pulse Power Rating Curve

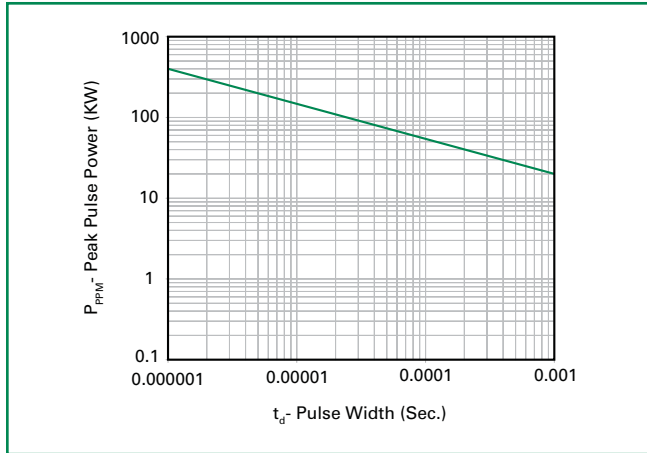

Figure 2 - Pulse Derating Curve

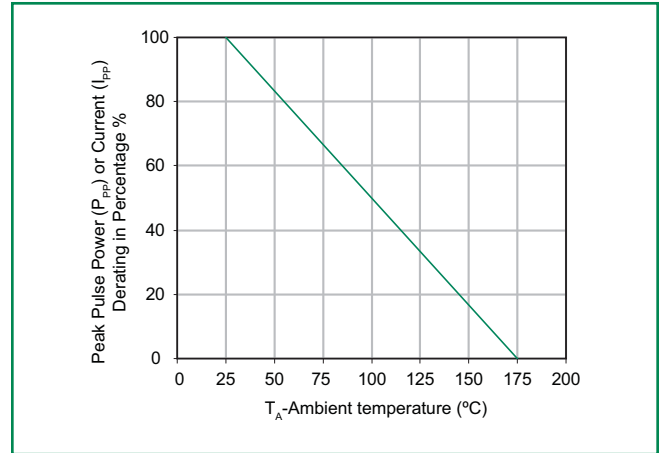

Figure 3 - Pulse Waveform

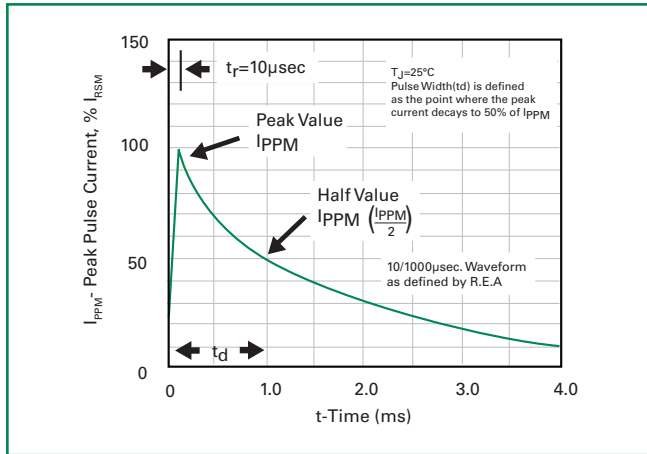

Figure 4 - Typical Junction Capacitance

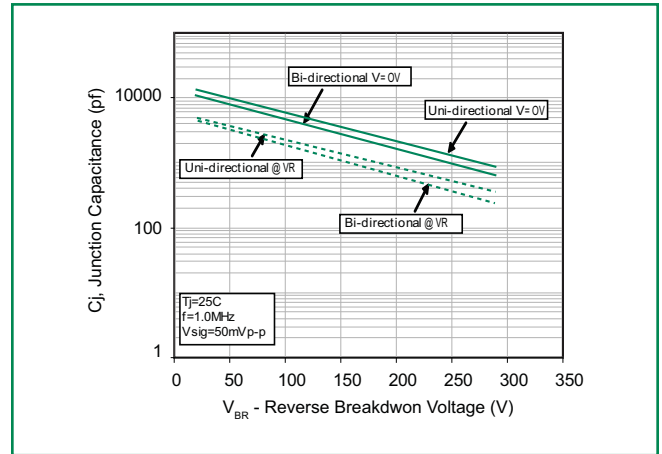

Figure 5 - Steady State Power Derating Curve

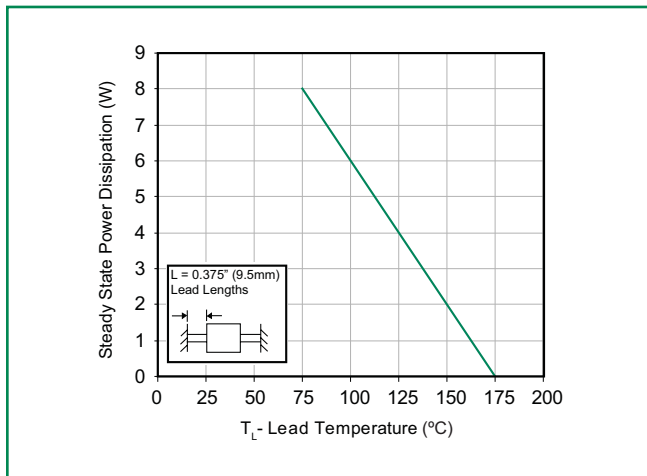
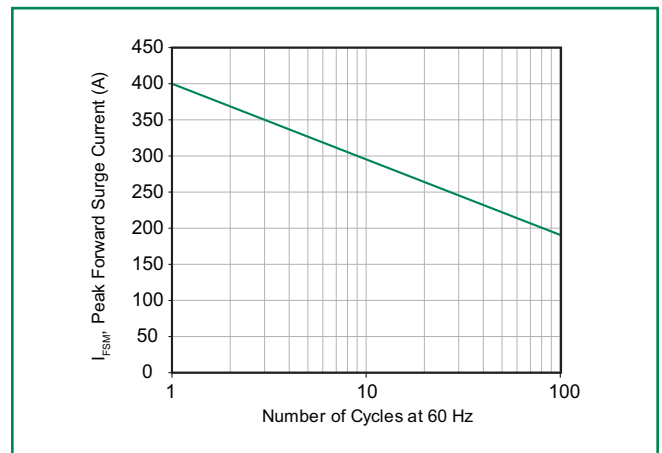
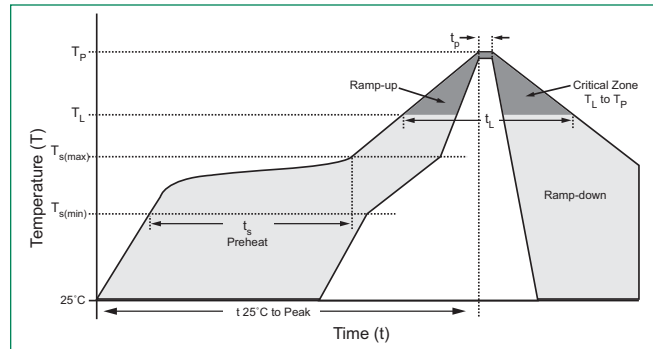

Figure 6 - Maximum Non-Repetitive Peak Forward Surge Current



Soldering Parameters

Reflow Condition		Lead-free assembly
Pre Heat	- Temperature Min ($T_{s(min)}$)	150°C
	- Temperature Max ($T_{s(max)}$)	200°C
	- Time (min to max) (t_s)	60 – 180 secs
Average ramp up rate (Liquidus Temp (T_L) to peak)		3°C/second max
$T_{s(max)}$ to T_L - Ramp-up Rate		3°C/second max
Reflow	- Temperature (T_L) (Liquidus)	217°C
	- Time (min to max) (t_s)	60 – 150 seconds
Peak Temperature (T_p)		260 ^{+0/-5} °C
Time within 5°C of actual peak Temperature (t_p)		20 – 40 seconds
Ramp-down Rate		6°C/second max
Time 25°C to peak Temperature (T_p)		8 minutes Max.
Do not exceed		280°C



Flow/Wave Soldering (Solder Dipping)

Peak Temperature :	265°C
Dipping Time :	10 seconds
Soldering :	1 time

Physical Specifications

Weight	0.07oz., 2.5g
Case	P600 molded plastic body over passivated junction.
Polarity	Color band denotes the cathode except Bipolar.
Terminal	Matte Tin axial leads, solderable per JESD22-B102D.

Environmental Specifications

Temperature Cycle	JESD22-A104
Pressure Cooker	JESD 22-A102
High Temp. Storage	JESD22-A103
HTRB	JESD22-A108
Thermal Shock	JESD22-A106

Dimensions

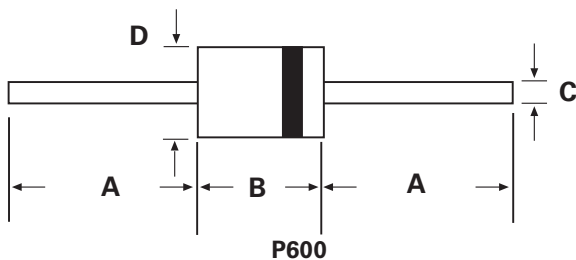

Dimensions	Inches		Millimeters	
	Min	Max	Min	Max
A	1.000	-	25.40	-
B	0.340	0.360	8.60	9.10
C	0.048	0.052	1.22	1.32
D	0.340	0.360	8.60	9.10

Part Numbering System

20KPA xxx XX X

OPTION CODE:

- BLANK** Reel Tape
- B** Bulk Packaging

TYPE CODE:

- A** Uni-Directional (5% Voltage Tolerance)
- CA** Bi-Directional

VOLTAGE CODE

(Refer to the Electrical Characteristics table)

SERIES CODE

Part Marking System

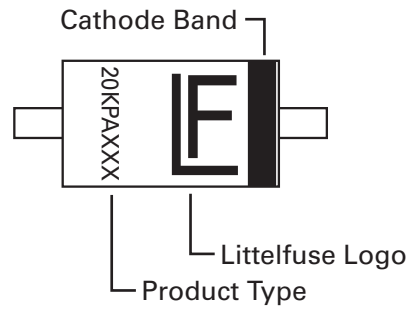

Packaging

Part Number	Component Package	Quantity	Packaging Option	Packaging Specification
20KPAxxxXX	P600	800	Tape & Reel	EIA STD RS-296E
20KPAxxxXX-B	P600	500	BULK	Littelfuse Concord Packing Spec. DM-0016

RoHS 30KPA Series

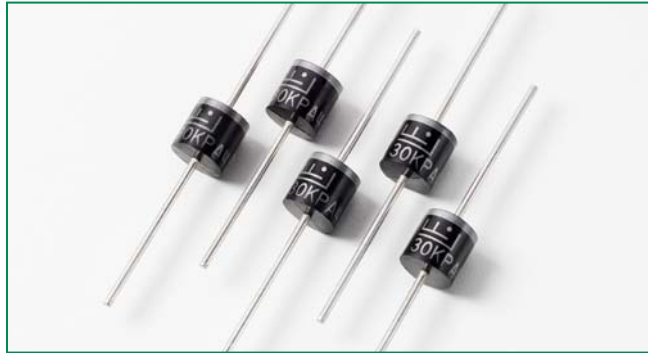

Agency Approvals

AGENCY	AGENCY FILE NUMBER
	E230531

**Maximum Ratings and Thermal Characteristics
(T_A=25°C unless otherwise noted)**

Parameter	Symbol	Value	Unit
Peak Pulse Power Dissipation by 10x1000µs test waveform (Fig.1) (Note 1)	P _{PPM}	30000	W
Steady State Power Dissipation on infinite heat sink at T _L =75°C (Fig. 5)	P _D	8.0	W
Peak Forward Surge Current, 8.3ms Single Half Sine Wave Unidirectional only (Note 2)	I _{FSM}	400	A
Operating Junction and Storage Temperature Range	T _J , T _{STG}	-55 to 175	°C
Typical Thermal Resistance Junction to Lead	R _{θJL}	8.0	°C/W
Typical Thermal Resistance Junction to Ambient	R _{θJA}	40	°C/W

Notes:

1. Non-repetitive current pulse, per Fig. 3 and derated above T_A = 25°C per Fig. 2.
2. Measured on 8.3ms single half sine wave or equivalent square wave, duty cycle=4 per minute maximum.

Description

The 30KPA Series is designed specifically to protect sensitive electronic equipment from voltage transients induced by lightning and other transient voltage events.

Features

- RoHS compliant
- Typical maximum temperature coefficient $\Delta V_{BR} = 0.1\% \times V_{BR} @ 25^\circ\text{C}$
- Glass passivated chip junction in P600 package
- 30000W peak pulse capability at 10x1000µs waveform, repetition rate (duty cycles):0.01%
- Fast response time: typically less than 1.0ps from 0 Volts to BV min
- Excellent clamping capability
- Low incremental surge resistance
- Typical I_R less than 2µA above 73V
- High temperature soldering guaranteed: 260°C/40 seconds / 0.375"(9.5mm) lead length, 5 lbs., (2.3kg) tension
- Plastic package has Underwriters Laboratory Flammability classification 94V-0
- Matte Tin Lead-free plated

Applications

TVS devices are ideal for the protection of I/O interfaces, V_{CC} bus and other vulnerable circuits used in telecom, computer, industrial and consumer electronic applications.

30KPA Series

Electrical Characteristics

Part Number (Uni)	Part Number (Bi)	Reverse Stand off Voltage V_R (Volts)	Breakdown Voltage V_{BR} (Volts) @ I_T	Test Current I_T (mA)	Maximum Peak Pulse Current I_{PP} (A)	Maximum Reverse Leakage I_R @ V_R (μ A)	Maximum Clamping Voltage V_C @ I_{PP} (V)	Agency Approval 
			MIN					
30KPA28A	30KPA28CA	28	31.28	50	606.0	5000	50.0	X
30KPA30A	30KPA30CA	30	33.51	50	548.9	5000	55.2	X
30KPA33A	30KPA33CA	33	36.90	50	517.9	5000	58.5	X
30KPA36A	30KPA36CA	36	40.20	50	490.3	5000	61.8	X
30KPA39A	30KPA39CA	39	43.60	20	450.9	2000	67.2	X
30KPA42A	30KPA42CA	42	46.90	10	420.8	1000	72.0	X
30KPA43A	30KPA43CA	43	48.00	10	415.1	1000	73.0	X
30KPA45A	30KPA45CA	45	50.30	5	391.5	250	77.4	X
30KPA48A	30KPA48CA	48	53.60	5	371.3	150	81.6	X
30KPA51A	30KPA51CA	51	57.00	5	350.7	50	86.4	X
30KPA54A	30KPA54CA	54	60.30	5	331.5	20	91.4	X
30KPA58A	30KPA58CA	58	64.80	5	327.9	20	92.4	X
30KPA60A	30KPA60CA	60	67.00	5	297.1	15	102.0	X
30KPA64A	30KPA64CA	64	71.50	5	291.3	10	104.0	X
30KPA66A	30KPA66CA	66	73.70	5	283.2	2	107.0	X
30KPA70A	30KPA70CA	70	78.20	5	278.0	2	109.0	X
30KPA71A	30KPA71CA	71	79.30	5	271.7	2	111.5	X
30KPA72A	30KPA72CA	72	80.40	5	265.8	2	114.0	X
30KPA75A	30KPA75CA	75	83.80	5	253.8	2	119.4	X
30KPA78A	30KPA78CA	78	87.10	5	234.9	2	129.0	X
30KPA84A	30KPA84CA	84	93.80	5	217.7	2	139.2	X
30KPA90A	30KPA90CA	90	100.50	5	207.0	2	146.4	X
30KPA96A	30KPA96CA	96	107.20	5	194.2	2	156.0	X
30KPA102A	30KPA102CA	102	113.90	5	183.0	2	165.6	X
30KPA108A	30KPA108CA	108	120.60	5	172.9	2	175.2	X
30KPA120A	30KPA120CA	120	134.00	5	155.9	2	194.4	X
30KPA132A	30KPA132CA	132	147.40	5	142.3	2	213.0	X
30KPA144A	30KPA144CA	144	160.80	5	135.8	2	223.2	X
30KPA150A	30KPA150CA	150	167.60	5	129.8	2	233.4	X
30KPA156A	30KPA156CA	156	174.30	5	123.7	2	245.0	X
30KPA160A	30KPA160CA	160	178.70	5	120.0	2	252.6	X
30KPA168A	30KPA168CA	168	187.70	5	111.2	2	272.4	X
30KPA170A	30KPA170CA	170	189.90	5	110.2	2	275.0	X
30KPA180A	30KPA180CA	180	201.10	5	104.3	2	290.4	X
30KPA198A	30KPA198CA	198	221.20	5	94.7	2	319.8	X
30KPA216A	30KPA216CA	216	241.30	5	86.9	2	348.6	X
30KPA240A	30KPA240CA	240	268.10	5	78.3	2	387.0	X
30KPA258A	30KPA258CA	258	288.20	5	72.8	2	416.4	X
30KPA260A	30KPA260CA	260	290.40	5	72.8	2	416.0	X
30KPA270A	30KPA270CA	270	301.60	5	69.5	2	436.2	X
30KPA280A	30KPA280CA	280	312.80	5	65.3	2	464.0	X
30KPA288A	30KPA288CA	288	321.70	5	64.5	2	469.9	X

For bidirectional type having V_{RWM} of 60 volts and less, the I_T limit is double.

For parts without A, the V_{BR} is $\pm 10\%$.

Ratings and Characteristic Curves ($T_A=25^\circ\text{C}$ unless otherwise noted)

Figure 1 - Peak Pulse Power Rating Curve

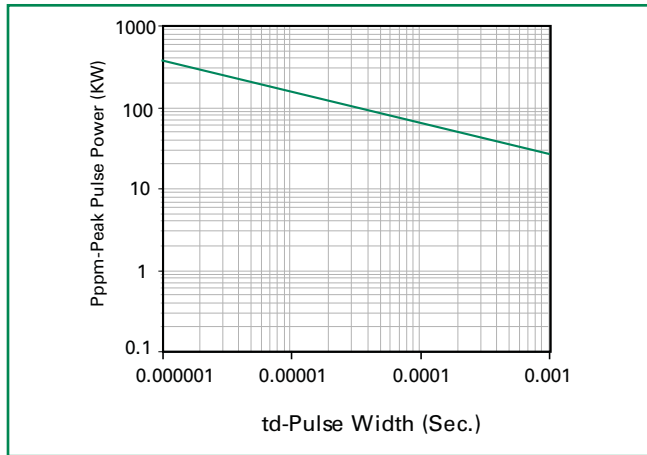

Figure 2 - Pulse Derating Curve

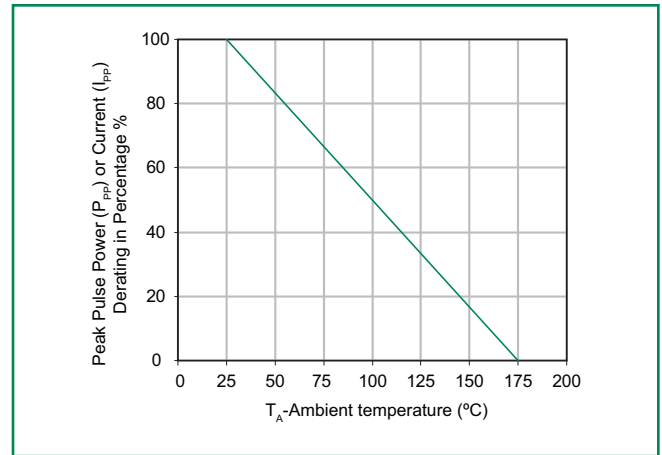

Figure 3 - Pulse Waveform

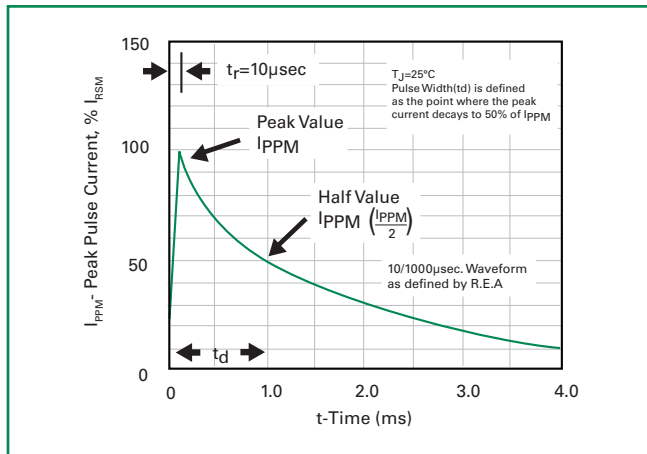

Figure 4 - Typical Junction Capacitance

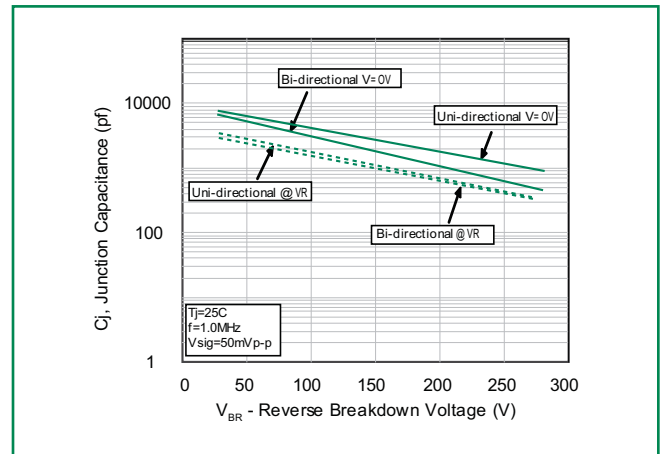

Figure 5 - Steady State Power Derating Curve

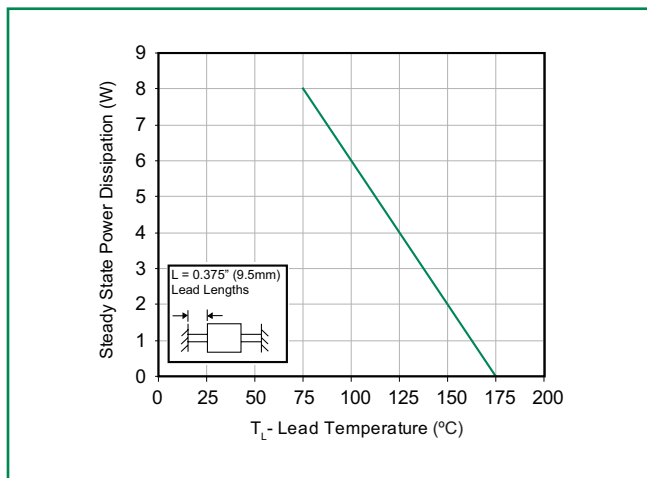
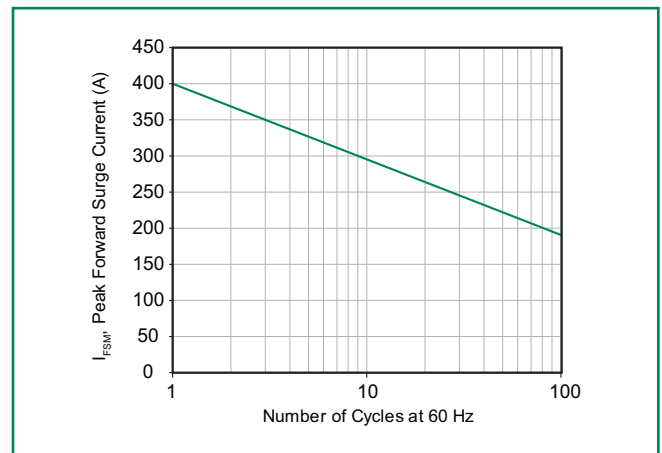
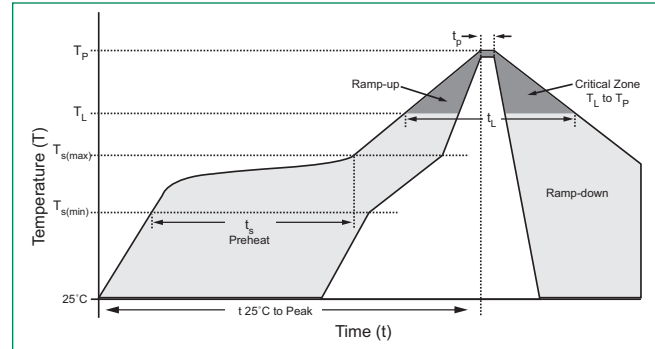

Figure 6 - Maximum Non-Repetitive Peak Forward Surge Current



Soldering Parameters

Reflow Condition		Lead-free assembly
Pre Heat	- Temperature Min ($T_{s(min)}$)	150°C
	- Temperature Max ($T_{s(max)}$)	200°C
	- Time (min to max) (t_s)	60 – 180 secs
Average ramp up rate (Liquidus Temp (T_L) to peak)		3°C/second max
$T_{s(max)}$ to T_L - Ramp-up Rate		3°C/second max
Reflow	- Temperature (T_L) (Liquidus)	217°C
	- Time (min to max) (t_s)	60 – 150 seconds
Peak Temperature (T_p)		260 ^{+0/-5} °C
Time within 5°C of actual peak Temperature (t_p)		20 – 40 seconds
Ramp-down Rate		6°C/second max
Time 25°C to peak Temperature (T_p)		8 minutes Max.
Do not exceed		280°C



Flow/Wave Soldering (Solder Dipping)

Peak Temperature :	265°C
Dipping Time :	10 seconds
Soldering :	1 time

Physical Specifications

Weight	0.07oz., 2.5g
Case	P600 molded plastic body over passivated junction.
Polarity	Color band denotes the cathode except Bipolar.
Terminal	Matte Tin axial leads, solderable per JESD22-B102D.

Environmental Specifications

Temperature Cycle	JESD22-A104
Pressure Cooker	JESD 22-A102
High Temp. Storage	JESD22-A103
HTRB	JESD22-A108
Thermal Shock	JESD22-A106

Dimensions

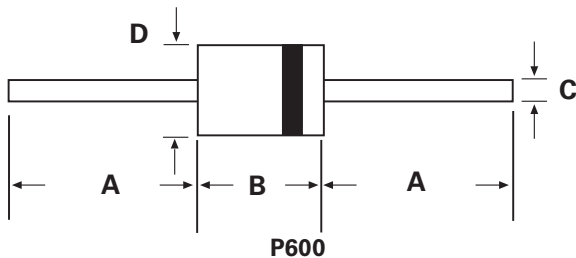

Dimensions	Inches		Millimeters	
	Min	Max	Min	Max
A	1.000	-	25.40	-
B	0.340	0.360	8.60	9.10
C	0.048	0.052	1.22	1.32
D	0.340	0.360	8.60	9.10

Part Numbering System

30KPA xxx XX X

OPTION CODE:

- BLANK** Reel Tape
- B** Bulk Packaging

TYPE CODE:

- A** Uni-Directional (5% Voltage Tolerance)
- CA** Bi-Directional

VOLTAGE CODE

(Refer to the Electrical Characteristics table)

SERIES CODE

Part Marking System

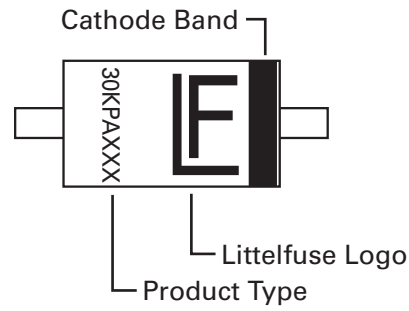

Packaging

Part Number	Component Package	Quantity	Packaging Option	Packaging Specification
30KPAxxxXX	P600	800	Tape & Reel	EIA STD RS-296E
30KPAxxxXX-B	P600	500	BULK	Littelfuse Concord Packing Spec. DM-0016

RoHS AK6 Series



Description

The new AK6 series of high current transient suppressors have been specially designed for use in A.C. line protection and any demanding applications (AC or DC). They offer superior clamping characteristics over standard S.A.D. technologies by virtue of the Littelfuse Foldbak™ technology, which provides a clamping voltage lower than the avalanche voltage (but above the rated working voltage). Therefore, any voltage rise due to increased current conduction is contained to a minimum, providing the best possible protection level. They can also be connected in series and/or parallel to create very high capacity protection solutions.

Agency Approvals

AGENCY	AGENCY FILE NUMBER
	E128662

Maximum Ratings and Thermal Characteristics
(T_A=25°C unless otherwise noted)

Parameter	Symbol	Value	Unit
Operating Junction and Storage Temperature Range	T _J , T _{STG}	(-)55 to 150	°C
Current Rating ¹	I _{PP}	6	kA

Note:

1. Rated I_{PP} measured with 8 x 20µS pulse.

Features

- RoHS compliant
- Foldbak™ technology for superior clamping factor
- Glass Passivated Junction for reliability
- Bi-directional
- Ultra compact: 12 times less volume than traditional discrete solutions
- Very Low Clamping Voltage
- Sharp Breakdown Voltage
- Low Slope Resistance

Electrical Characteristics

Part Numbers	Standoff Voltage (V _{SO}) Volts	Max. Reverse Leakage (I _R) @ V _{SO} µA	Reverse Breakdown Voltage (V _{BR}) @ I _T		Test Current I _T (mA)	Max. Clamping Voltage V _{CL} @ I _{PP} Peak Pulse Current (I _{PP}) (Note 1)		Max. Temp Coefficient OF V _{BR} (%/°C)	Max. Capacitance 0 Bias 10kHz (nF)	Agency Approval
			Min Volts	Max Volts		V _{CL} Volts	I _{PP} Amps			
AK6 - 058C	58	20	64	70	10	110	6,000	0.1	8	X
AK6 - 076C	76	20	85	95	10	140	6,000	0.1	6.5	X
AK6 - 170C	170	20	180	220	10	260	6,000	0.1	2.8	X
AK6 - 190C	190	20	200	245	10	290	6,000	0.1	2.5	X
AK6 - 240C	240	20	250	285	10	340	6,000	0.1	2.0	X
AK6 - 380C	380	20	401	443	10	520	6,000	0.1	1.4	X
AK6 - 430C	430	20	440	490	10	625	6,000	0.1	1.0	X

Soldering Parameters

Reflow Condition		Lead-free assembly
Pre Heat	- Temperature Min ($T_{s(min)}$)	150°C
	- Temperature Max ($T_{s(max)}$)	200°C
	- Time (min to max) (t_s)	60 – 180 secs
Average ramp up rate (Liquidus Temp (T_L) to peak)		3°C/second max
$T_{s(max)}$ to T_L - Ramp-up Rate		3°C/second max
Reflow	- Temperature (T_L) (Liquidus)	217°C
	- Time (min to max) (t_s)	60 – 150 seconds
Peak Temperature (T_p)		260 ^{+0/-5} °C
Time within 5°C of actual peak Temperature (t_p)		20 – 40 seconds
Ramp-down Rate		6°C/second max
Time 25°C to peak Temperature (T_p)		8 minutes Max.
Do not exceed		280°C

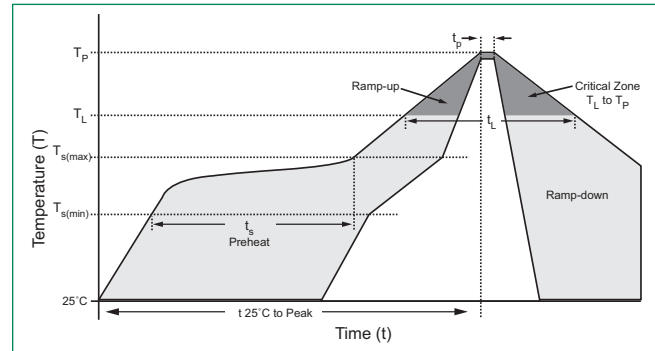

Flow/Wave Soldering (Solder Dipping)

Peak Temperature :	265°C
Dipping Time :	10 seconds
Soldering :	1 time

Physical Specifications

Weight	Contact manufacturer
Case	Epoxy encapsulated
Terminal	Silver plated leads, solderable per MIL-STD-202 Method 208

Ratings and Characteristic Curves ($T_a=25^\circ\text{C}$ unless otherwise noted)

Peak Power Derating

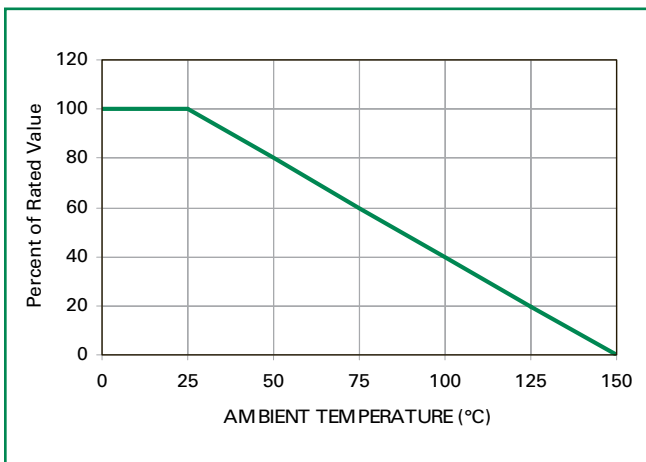

Dimensions

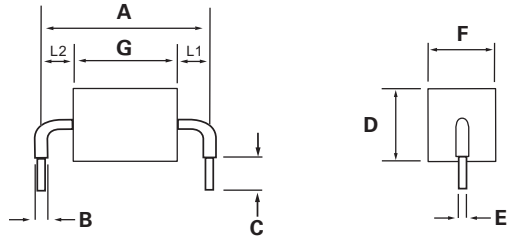

Dimensions	Inches	Millimeters
A	0.950	24.15
B	0.095	2.4
C - 058C/076C	0.236	6.00
C	0.145	3.68
D	0.570 max.	14.48 max.
E	0.050	1.270
F	0.500 max.	12.70 max.
G - 058C/076C	0.200	5.08
G - 170C/190C	0.320	8.13
G - 240C	0.370	9.4
G - 380C/430C	0.543	13.8
L1	0.310	7.87
L1 - 380C/430C	0.150	3.81

L2= A - (G+L1) tolerance +/- 0.04 inch (1.0 mm)

Part Marking System

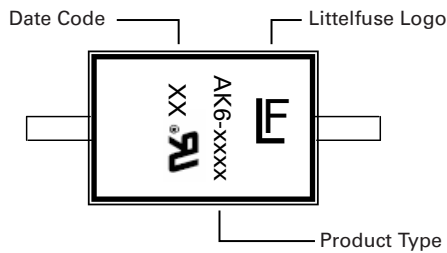

Note: UL mark does not appear on -058C & -076C.

Part Numbering System

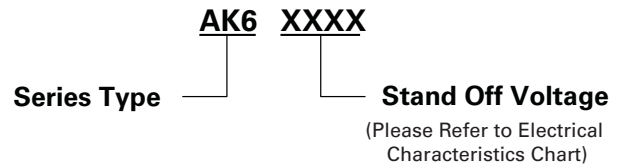

RoHS AK10 Series

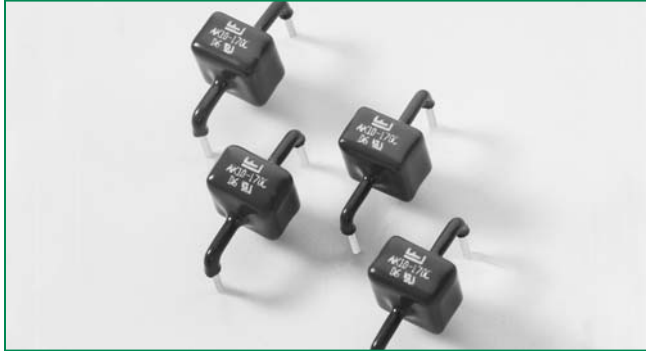

Description

The new AK10 series of high current transient suppressors have been specially designed for use in A.C. line protection and any demanding applications (AC or DC). They offer superior clamping characteristics over standard S.A.D. technologies by virtue of the Littelfuse Foldbak™ technology, which provides a clamping voltage lower than the avalanche voltage (but above the rated working voltage). Therefore, any voltage rise due to increased current conduction is contained to a minimum, providing the best possible protection level. They can also be connected in series and/or parallel to create very high capacity protection solutions.

Agency Approvals

AGENCY	AGENCY FILE NUMBER
	E128662

Maximum Ratings and Thermal Characteristics
(T_A = 25°C unless otherwise noted)

Parameter	Symbol	Value	Unit
Operating Junction and Storage Temperature Range	T _J , T _{STG}	(-55 to 150)	°C
Current Rating ¹	I _{PP}	10	kA

Note:

1. Rated I_{PP} measured with 8 x 20µs pulse.

Features

- RoHS compliant
- Foldbak™ technology for superior clamping factor
- Glass Passivated Junction
- Bi-directional
- Ultra Compact: 12 times less volume than traditional discrete solutions
- Very Low Clamping Voltage
- Sharp Breakdown Voltage
- Low Slope Resistance

Electrical Characteristics

Part Numbers	Standoff Voltage (V _{SO}) Volts	Max. Reverse Leakage (I _R) @ V _{SO} µA	Reverse Breakdown Voltage (V _{BR}) @ I _T		Test Current I _T (mA)	Max. Clamping Voltage V _{CL} @ Peak Pulse Current (I _{PP}) (Note 1)		Max. Temp Coefficient of V _{BR} (%/°C)	Max. Capacitance 0 Bias 10kHz (nF)	Agency Approval
			Min Volts	Max Volts		V _{CL} Volts	I _{PP} Amps			
AK10 - 058C	58	20	64	70	10	110	10,000	0.1	6.5	X
AK10 - 076C	76	20	85	95	10	140	10,000	0.1	6.5	X
AK10 - 170C	170	20	180	220	10	260	10,000	0.1	2.8	X
AK10 - 190C	190	20	200	245	10	290	10,000	0.1	2.5	X
AK10 - 240C	240	20	250	285	10	340	10,000	0.1	2.2	X
AK10 - 380C	380	20	401	443	10	520	10,000	0.1	2.0	X
AK10 - 430C	430	20	440	490	10	625	10,000	0.1	1.4	X

Note: Using 8 x 20µs wave shaped defined in IEC 61000-4-5.

AK10 Series

Soldering Parameters

Reflow Condition		Lead-free assembly
Pre Heat	- Temperature Min ($T_{s(min)}$)	150°C
	- Temperature Max ($T_{s(max)}$)	200°C
	- Time (min to max) (t_s)	60 – 180 secs
Average ramp up rate (Liquidus Temp (T_L) to peak)		3°C/second max
$T_{s(max)}$ to T_L - Ramp-up Rate		3°C/second max
Reflow	- Temperature (T_L) (Liquidus)	217°C
	- Time (min to max) (t_s)	60 – 150 seconds
Peak Temperature (T_p)		260 ^{+0/-5} °C
Time within 5°C of actual peak Temperature (t_p)		20 – 40 seconds
Ramp-down Rate		6°C/second max
Time 25°C to peak Temperature (T_p)		8 minutes Max.
Do not exceed		280°C

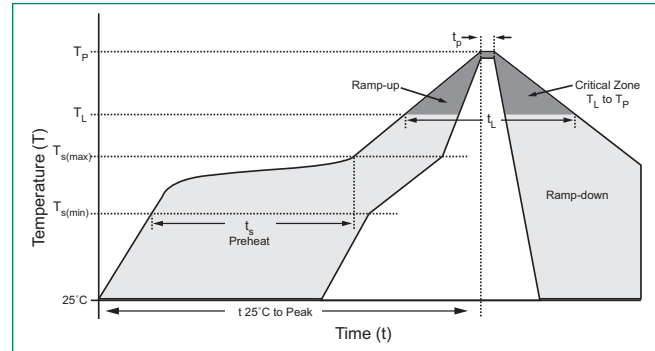

Flow/Wave Soldering (Solder Dipping)

Peak Temperature :	265°C
Dipping Time :	10 seconds
Soldering :	1 time

Physical Specifications

Weight	Contact manufacturer
Case	Epoxy encapsulated
Terminal	Silver plated leads, solderable per MIL-STD-202 Method 208

Ratings and Characteristic Curves ($T_A=25^\circ\text{C}$ unless otherwise noted)

Peak Power Derating

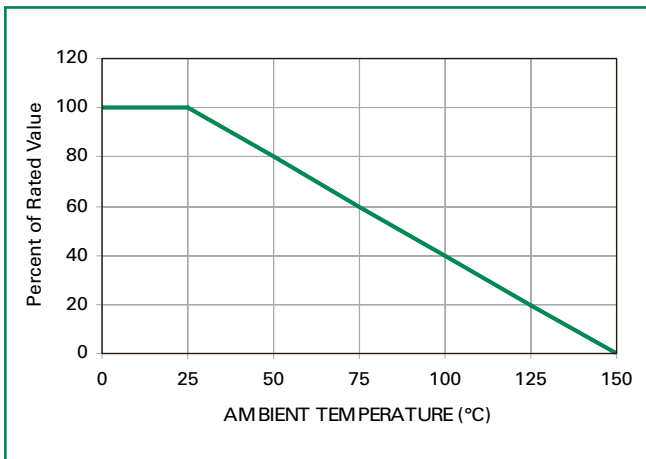

Dimensions

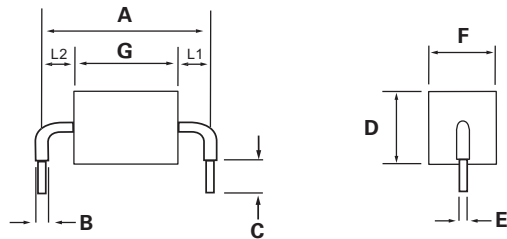

Dimensions	Inches	Millimeters
A	0.950	24.15
B	0.095	2.4
C - 058C/076C	0.236	6.00
C	0.145	3.68
D	0.570 max.	14.48 max.
E	0.050	1.270
F	0.500 max.	12.70 max.
G - 058C/076C	0.200	5.08
G - 170C/190C	0.362	9.2
G - 240C	0.420	10.67
G - 380C/430C	0.650	16.50
L1	0.310	7.87
L1 - 380C/430C	0.177	4.5
L2= A - (G+L1) tolerance +/- 0.04 inch (1.0 mm)		

Part Marking System

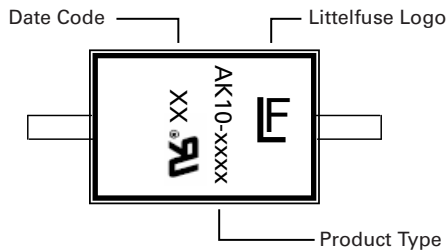

Note: UL mark does not appear on -058C and -076C.

Part Numbering System

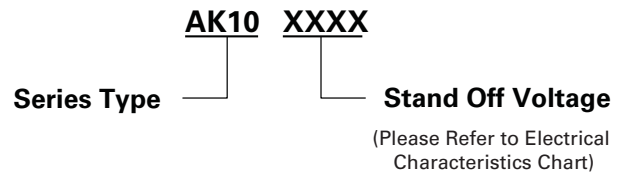

RoHS SLD Series

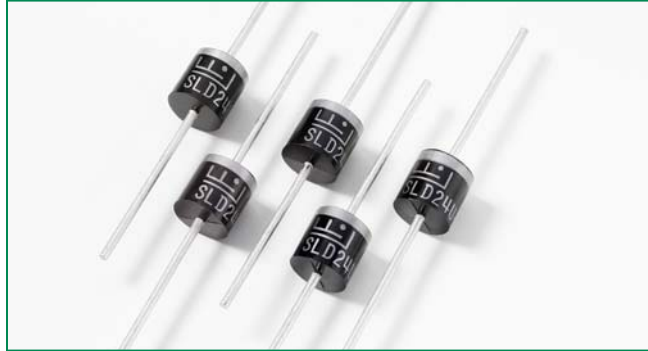

Agency Approvals

AGENCY	AGENCY FILE NUMBER
	E230531

Maximum Ratings and Thermal Characteristics
(T_A=25°C unless otherwise noted)

Parameter	Symbol	Value	Unit
Peak Pulse Power Dissipation 1. 100µs x 150ms test waveform 2. 8 x 20µs test waveform	P _{PPM}	2200	W
		50000	W
Steady State Power Dissipation on infinite heat sink at T _L =75°C (Fig. 5)	P _{M(AV)}	8.0	W
Maximum Instantaneous Forward Voltage at 100A for Unidirectional only	V _F	3.5	V
Operating Junction and Storage Temperature Range	T _J , T _{STG}	-65 to 175	°C
Typical Thermal Resistance Junction to Lead	R _{UJL}	8.0	°C/W
Typical Thermal Resistance Junction to Ambient	R _{UJA}	40	°C/W

Description

The SLD Series is packaged in a highly reliable industry standard P600 axial leaded package and is designed to provide precision overvoltage protection for sensitive electronics.

Features

- RoHS compliant
- Typical maximum temperature coefficient
 $\Delta V_{BR} = 0.1\% \times V_{BR} @ 25^\circ\text{C}$
- Glass passivated chip junction in P600 package
- 2200W peak pulse capability at 100µs x 150ms waveform, repetition rate (duty cycles): 0.01%
- Fast response time: typically less than 1.0ps from 0 Volts to BV min
- Excellent clamping capability
- Low incremental surge resistance
- High temperature soldering guaranteed: 260°C/40 seconds / 0.375"/(9.5mm) lead length, 5 lbs., (2.3kg) tension
- Plastic package has Underwriters Laboratory Flammability classification 94V-O
- Matte Tin Lead-free plated

Applications

Designed to protect sensitive electronics from:

- Inductive Load Switching
- Alternator Load Dump

Electrical Characteristics (T_A=25°C unless otherwise noted)

Part Number (Uni)	Part Number (Bi)	Breakdown Voltage V _{BR} @ I _T		Test Current I _T (mA)	Reverse Stand off Voltage V _R (Volts)	Maximum Reverse Leakage @ V _R I _R (µA)	Maximum Peak Pulse Current I _{pp} (A)	Maximum Clamping Voltage @ I _{pp} V _C (V)	Agency Approval
		MIN	MAX						
SLD10U-017	SLD10-018	11.8	13	5.0	10	10	115	19.0	x
SLD16U-017	SLD16-018	18.0	22.0	1.0	16	10	76	28.6	x
SLD24U-017	SLD24-018	25.0	30.0	1.0	24	10	61	36.0	x

Notes:

1. V_{BR} measured after I_T applied for 300µs, I_T = square wave pulse or equivalent.
2. Surge current waveform per 100µs x 150ms exponential wave and derated per Fig. 3.
3. All terms and symbols are consistent with ANSI/IEEE C62.35.

Ratings and Characteristic Curves ($T_A=25^\circ\text{C}$ unless otherwise noted)

Figure 1 - Peak Pulse Power Rating Curve

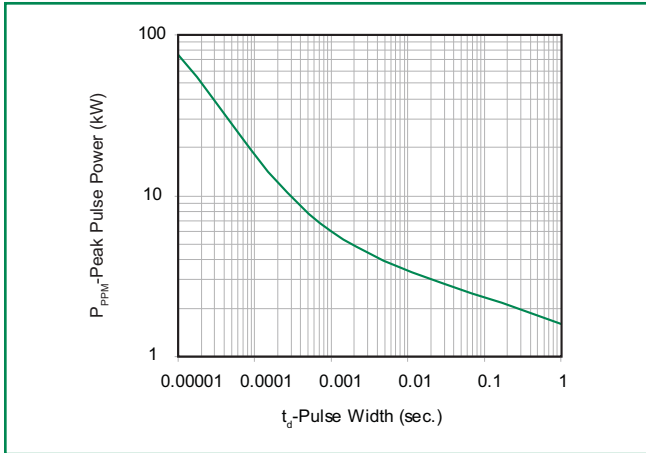

Figure 2 - Pulse Derating Curve

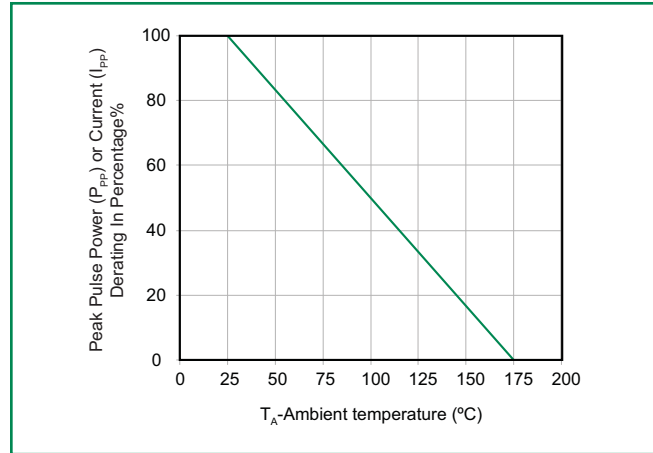

Figure 3 - Pulse Waveform

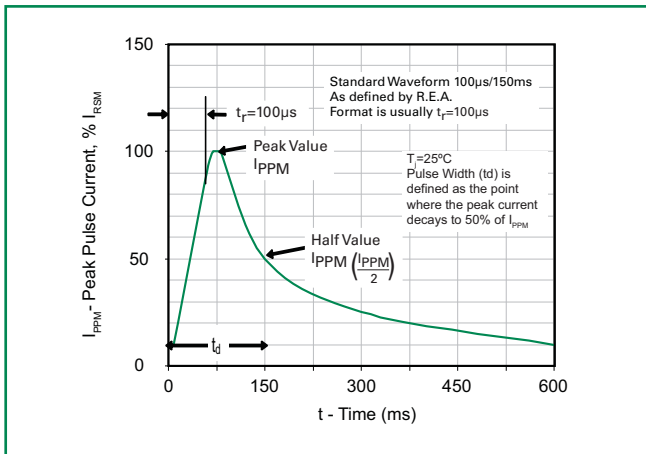

Figure 4 - Typical Junction Capacitance

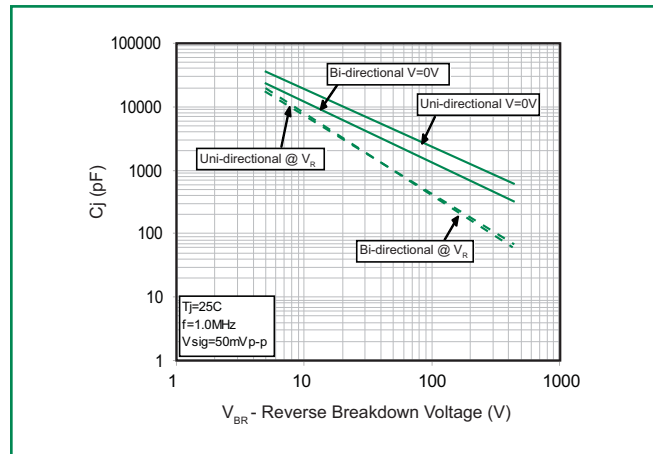

Figure 5 - Steady State Power Derating Curve

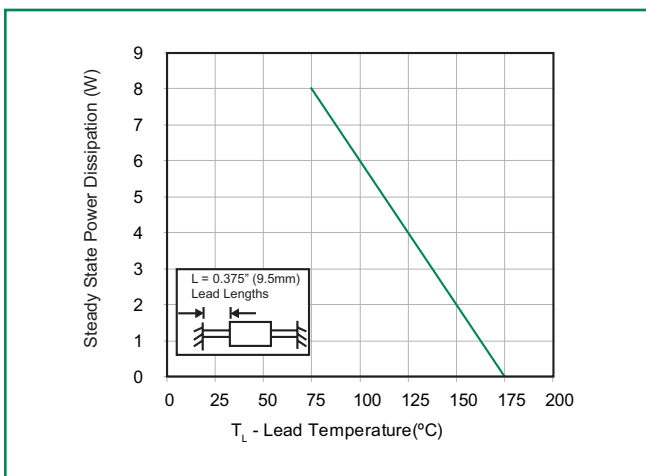
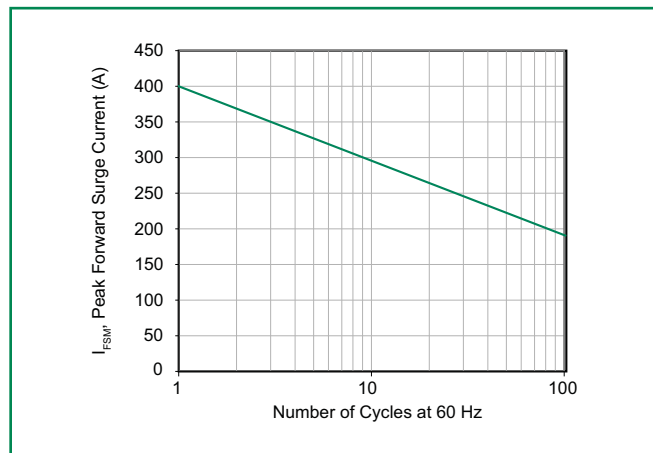
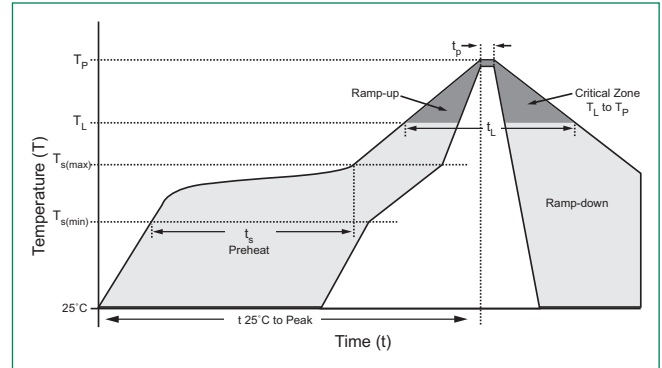

Figure 6 - Maximum Non-Repetitive Peak Forward Surge Current



Soldering Parameters

Reflow Condition		Lead-free assembly
Pre Heat	- Temperature Min ($T_{s(min)}$)	150°C
	- Temperature Max ($T_{s(max)}$)	200°C
	- Time (min to max) (t_s)	60 – 180 secs
Average ramp up rate (Liquidus Temp (T_L) to peak)		3°C/second max
$T_{s(max)}$ to T_L - Ramp-up Rate		3°C/second max
Reflow	- Temperature (T_L) (Liquidus)	217°C
	- Time (min to max) (t_s)	60 – 150 seconds
Peak Temperature (T_p)		260 ^{+0/-5} °C
Time within 5°C of actual peak Temperature (t_p)		20 – 40 seconds
Ramp-down Rate		6°C/second max
Time 25°C to peak Temperature (T_p)		8 minutes Max.
Do not exceed		280°C



Flow/Wave Soldering (Solder Dipping)

Peak Temperature :	265°C
Dipping Time :	10 seconds
Soldering :	1 time

Physical Specifications

Weight	0.07oz., 2.1g
Case	P600 molded plastic body over passivated junction.
Polarity	Color band denotes the cathode except Bipolar.
Terminal	Matte Tin axial leads, solderable per JESD22-B102D.

Environmental Specifications

Temperature Cycle	JESD22-A104
Pressure Cooker	JESD 22-A102
High Temp. Storage	JESD22-A103
HTRB	JESD22-A108
Thermal Shock	JESD22-A106

Dimensions

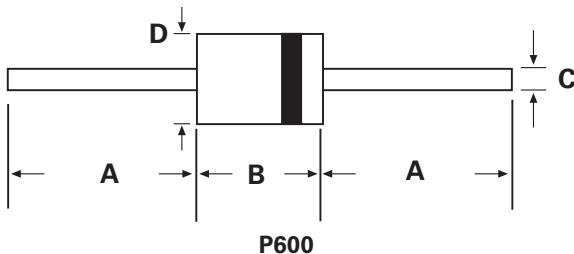

Dimensions	Inches		Millimeters	
	Min	Max	Min	Max
A	1.000	-	25.40	-
B	0.340	0.360	8.60	9.10
C	0.048	0.052	1.22	1.32
D	0.340	0.360	8.60	9.10

Part Numbering System

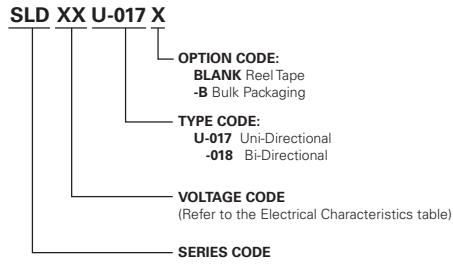

Part Marking System

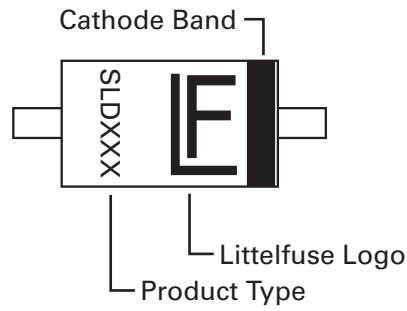

Packaging

Part Number	Component Package	Quantity	Packaging Option	Packaging Specification
SLDxxXXX	P600	800	Tape & Reel	EIA STD RS-296E
SLDxxXX-B	P600	500	BOX	Littelfuse Concord Packing Spec. DM-0016



http://littelfuse.com

To assist you with your electronics design and selection processes, Littelfuse also offers:

Comprehensive Online Product Specs on Littelfuse.com—Featuring easy-to-use navigation, search and selection tools, as well as additional product details. You can rely on Littelfuse.com for instant answers and continuously up-to-date information.

Printed Product Catalogs—For offline and off-the-shelf convenience, our printed product catalogs include data sheets, selection tables and tutorials covering all of our core technologies. Contact your Littelfuse product representative or visit www.littelfuse.com/catalogs to check availability.

Circuit Protection Design Guides—Our application design center website, www.littelfuse.com/designcenter, offers a wealth of circuit protection guidance to help you select and apply the best circuit protection solution for your application.

As the world's #1 brand in circuit protection, Littelfuse offers a complete portfolio of circuit protection products. To request catalogs for the Littelfuse portfolio of circuit protection technologies, please contact your authorized Littelfuse product representative or visit our website at www.littelfuse.com/catalogs

Littelfuse offers several technologies to protect sensitive electronic circuits from excess current resulting from overloads, short circuits, power cross or ground faults. Our overcurrent protection product line includes:

Fuses Littelfuse offers the world's broadest range of fuse types and ratings, including cartridge, leaded, surface mount and thin film designs

PTC Protectors Positive Temperature Coefficient thermistor technology provides resettable current-limiting protection



Littelfuse offers multiple technologies for overvoltage suppression and switching to protect sensitive electronic circuits from excessive voltage resulting from electrostatic discharge (ESD), load switching or lightning strikes. Our overvoltage protection product line includes:

Varistors Littelfuse offers surface mount Multi-Layer Varistors (MLVs) and industrial Metal Oxide Varistors (MOVs) to protect against transients

GDTs Gas Discharge Tubes (GDTs) to dissipate voltage through a contained plasma gas

Thyristors Littelfuse's solid state switches control the flow of current in a wide range of appliances, tools and equipment

SIDACTor® Devices Overvoltage protection specifically designed for telecom and datacom requirements

TVS Diodes Silicon transient voltage suppression (TVS) devices

SPAs Silicon Protection Arrays designed for analog and digital signal line protection

PulseGuard® ESD Suppressors Small, fast-acting Electrostatic Discharge (ESD) suppressors

