

Description

The 1812L Series PTC provides surface mount overcurrent protection for applications where resettable protection is desired.



Features

- RoHS compliant, lead-free and halogen-free¹
- Fast response
- Compact design
- Low resistance
- Low-profile
- Compatible with high temperature solders



Applications

- Plug and play protection for motherboards and peripherals
- USB peripherals
- PCI cards
- Game console port protection

Agency Approvals

AGENCY	AGENCY FILE NUMBER
	E183209
	R50119118

Electrical Characteristics

Part Number	Marking	I _{hold} (A)	I _{trip} (A)	V _{max} (Vdc)	I _{max} (A)	P _d typ. (W)	Max. Time To Trip		Resistance		Agency Approvals	
							Current (A)	Time (Sec.)	R _{min} (Ω)	R _{1max} (Ω)		
1812L010	LF010	0.10	0.30	30	100	0.8	0.50	1.50	1.600	15.000	X	X
1812L014	LF014	0.14	0.34	60	10	0.8	1.50	0.15	1.500	6.000	X	X
1812L020	LF020	0.20	0.40	30	100	0.8	8.00	0.02	0.800	5.000	X	X
1812L035/30	LF035-30	0.35	0.75	30	100	0.8	8.00	0.02	0.800	5.000	X	X
1812L050 ²	LF050	0.50	1.00	15	100	0.8	8.00	0.15	0.150	1.000	X	X
1812L050/30	LF050-30	0.50	1.00	30	100	0.8	8.00	0.15	0.150	1.000	X	X
1812L075 ²	LF075	0.75	1.50	13.2	100	0.8	8.00	0.20	0.100	0.450	X	X
1812L075/24	LF075-24	0.75	1.50	24	100	0.8	8.00	0.20	0.110	0.290	X	X
1812L075/33	LF075-33	0.75	1.50	33	20	0.8	8.00	0.20	0.110	0.400	X	X
1812L110 ²	LF110	1.10	2.20	6	100	0.8	8.00	0.30	0.040	0.210	X	X
1812L110/16	LF110-16	1.10	1.95	16	100	0.8	8.00	0.30	0.060	0.180	X	X
1812L110/24	LF110-24	1.10	1.95	24	20	0.8	8.00	0.50	0.060	0.200	X	X
1812L110/33	LF110-33	1.10	1.95	33	20	0.8	8.00	0.50	0.060	0.200	X	X
1812L125 ²	LF125	1.25	2.50	15	100	0.8	8.00	0.40	0.050	0.250	X	X
1812L125/6	LF125-6	1.25	2.50	6	100	0.8	8.00	0.40	0.050	0.140	X	X
1812L125/16	LF125-16	1.25	2.50	16	100	0.8	8.00	0.40	0.050	0.140	X	X
1812L150 ²	LF150	1.50	3.00	8	100	0.8	8.00	0.30	0.040	0.110	X	X
1812L150/12	LF150-12	1.50	3.00	12	100	0.8	8.00	0.50	0.040	0.110	X	X
1812L150/24	LF150-24	1.50	3.00	24	20	0.8	8.00	1.50	0.040	0.120	X	X
1812L160 ²	LF160	1.60	2.80	8	100	0.8	8.00	1.00	0.030	0.100	X	X
1812L160/12	LF160-12	1.60	2.80	12	100	0.8	8.00	1.00	0.030	0.100	X	X
1812L200TH ^{2,3}	LF200	2.00	3.50	8	100	0.8	8.00	2.00	0.020	0.070	X	X
1812L260TH ^{2,3}	LF260	2.60	5.00	8	100	0.8	8.00	2.50	0.015	0.047	X	X
1812L260/12	LF260-12	2.60	5.00	12	100	0.8	8.00	5.00	0.015	0.055	X	X
1812L300	LF300	3.00	5.00	6	100	0.8	8.00	4.00	0.012	0.040	X	X

I_{hold} = Hold current: maximum current device will pass without tripping in 20°C still air.
 I_{trip} = Trip current: minimum current at which the device will trip in 20°C still air.
 V_{max} = Maximum voltage device can withstand without damage at rated current (I_{max})
 I_{max} = Maximum fault current device can withstand without damage at rated voltage (V_{max})

P_d = Power dissipated from device when in the tripped state at 20°C still air.
 R_{min} = Minimum resistance of device in initial (un-soldered) state.
 R_{typ} = Typical resistance of device in initial (un-soldered) state.
 R_{1max} = Maximum resistance of device at 20°C measured one hour after tripping or reflow soldering of 260°C for 20 sec.

Caution: Operation beyond the specified rating may result in damage and possible arcing and flame.

1 Effective September 15, 2009 onward, all 1812L PTC products will be manufactured Halogen Free (HF). Existing Non-Halogen Free 1812L PTC products will continue to be sold until supplies are depleted. Effective January 1, 2010, all 1812L PTC product will be manufactured and sold as Halogen Free by default, and the "HF" part number suffix code will be discontinued – Refer to Part Ordering Number System and Packaging Options sections for additional information.

2 Some older references to these devices may include "-C" in the Part Number. The "-C" should be omitted when placing new orders for the device.

3 Part numbers ending in "TH" refer to new lower profile devices. For these items the "TH" suffix must be included in the ordering instructions.

Please refer also to the Dimensions and Part Ordering Number System sections of this document for additional information. Orders for the original thicker product (No TH in part number) may be accepted in some instances through October 31, 2009. Please contact Littelfuse for additional information or arrangements.

Temperature Derating

Part Number	Ambient Operation Temperature								
	-40°C	-20°C	0°C	23°C	40°C	50°C	60°C	70°C	85°C
	Hold Current (A)								
1812L010	0.16	0.14	0.12	0.10	0.08	0.07	0.06	0.05	0.03
1812L014	0.23	0.19	0.17	0.14	0.12	0.10	0.09	0.08	0.06
1812L020	0.29	0.26	0.23	0.20	0.17	0.15	0.14	0.12	0.10
1812L035/30	0.50	0.45	0.40	0.35	0.30	0.26	0.24	0.20	0.16
1812L050	0.77	0.68	0.59	0.50	0.44	0.40	0.37	0.33	0.29
1812L050/30	0.77	0.68	0.59	0.50	0.44	0.40	0.37	0.33	0.29
1812L075	1.15	1.01	0.88	0.75	0.65	0.60	0.55	0.49	0.43
1812L075/24	1.06	0.95	0.84	0.75	0.60	0.55	0.50	0.45	0.37
1812L075/33	1.10	1.00	0.88	0.75	0.66	0.60	0.56	0.47	0.36
1812L110	1.59	1.43	1.26	1.10	0.95	0.87	0.80	0.71	0.60
1812L110/16	1.58	1.43	1.27	1.10	0.95	0.85	0.77	0.71	0.58
1812L110/24	1.55	1.40	1.25	1.10	0.93	0.83	0.73	0.63	0.50
1812L110/33	1.55	1.40	1.25	1.10	0.93	0.83	0.73	0.63	0.50
1812L125	2.00	1.75	1.52	1.25	1.00	0.95	0.90	0.75	0.53
1812L125/6	2.00	1.75	1.52	1.25	1.00	0.95	0.90	0.75	0.53
1812L125/16	2.00	1.75	1.52	1.25	1.00	0.95	0.90	0.75	0.53
1812L150	2.06	1.93	1.79	1.50	1.28	1.10	1.02	0.80	0.68
1812L150/12	2.04	1.88	1.68	1.50	1.25	1.10	1.00	0.80	0.60
1812L150/24	2.05	1.87	1.67	1.50	1.25	1.08	0.95	0.77	0.60
1812L160	2.20	2.06	1.91	1.60	1.36	1.17	1.09	0.85	0.72
1812L160/12	2.20	2.06	1.91	1.60	1.36	1.17	1.09	0.85	0.72
1812L200TH	2.60	2.44	2.22	2.00	1.78	1.67	1.50	1.45	1.29
1812L260TH	3.40	3.16	3.00	2.60	2.30	2.15	2.00	1.85	1.63
1812L260/12	3.40	3.16	3.00	2.60	2.30	2.15	2.00	1.85	1.63
1812L300	4.13	3.75	3.30	3.00	2.61	2.43	2.25	2.00	1.78

Temperature Derating Curve

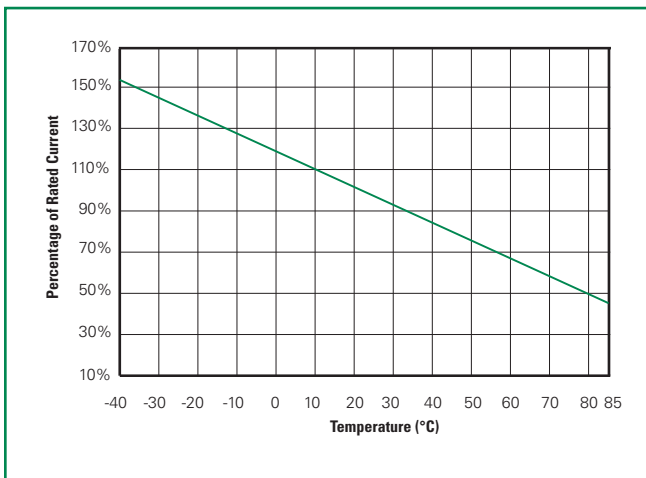

Physical Specifications

Terminal Material	Solder-Plated Copper (Solder Material: Matte Tin (Sn))
Lead Solderability	Meets EIA Specification RS186-9E, ANSI/J-STD-002 Category 3.

Environmental Specifications

Operating/Storage Temperature	-40°C to +85°C
Max. Device Surface Temp. in Tripped State	125°C
Passive Aging	+85°C, 1000 hours -/+5% typical resistance change
Humidity Aging	+85°C, 85% R.H., 1000 hours -/+5% typical resistance change
Thermal Shock	MIL-STD-202, Method 107G +85°C/-40°C 20 times -30% typical resistance change
Solvent Resistance	MIL-STD-202, Method 215, No change
Vibration	MIL-STD-883C, Method 2007.1, Condition A, No change
Moisture Level Sensitivity	Level 1, J-STD-020C

Average Time Current Curves

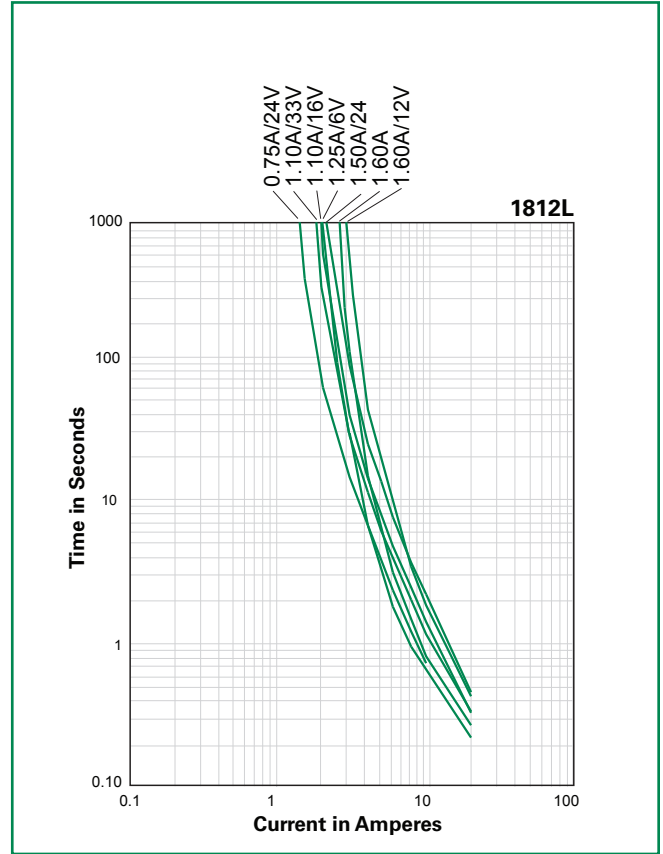
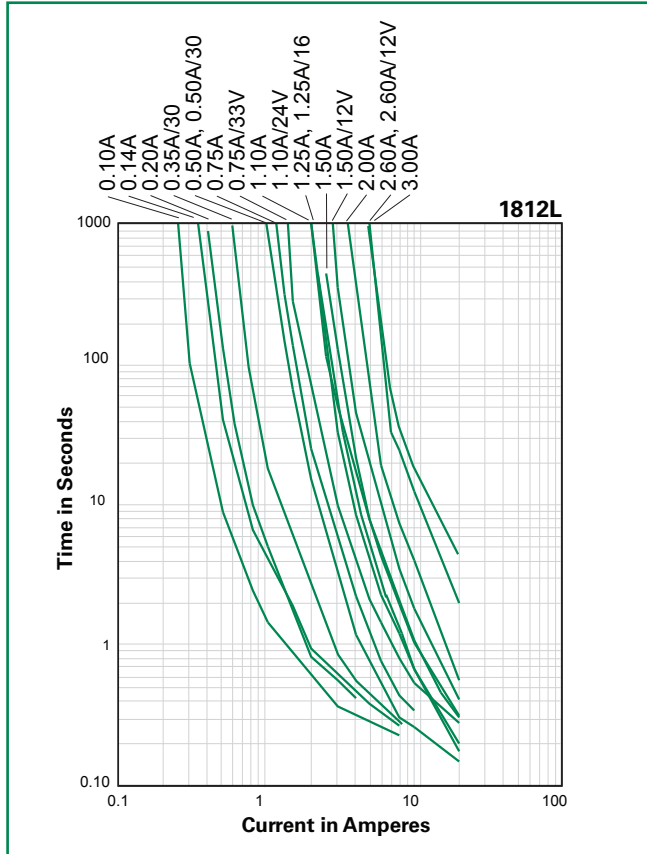

The average time current curves and Temperature Rerating curve performance is affected by a number of variables, and these curves provided as guidance only. Customer must verify the performance in their application.

1812L Series

Soldering Parameters

Condition	Reflow
Peak Temp/ Duration Time	260°C / 10 Sec
Time above liquids (TAL) 220°C	60 Sec ~ 100 Sec
Preheat 120°C~ 180°C	50 Sec ~ 150 Sec
Storage Condition	0°C~35°C, ≤70%RH

- Recommended reflow methods: IR, vapor phase oven, hot air oven, N₂ environment for lead-free
- Recommended maximum paste thickness is 0.25mm (0.010 inch)
- Devices can be cleaned using standard industry methods and solvents.

Note: If reflow temperatures exceed the recommended profile, devices may not meet the performance requirements.

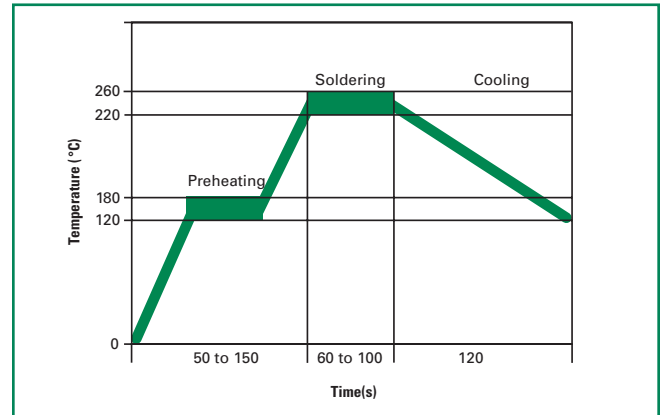

Dimensions

MARKING CODE VARIES
WITH AMPERAGE AND VOLTAGE RATING
(See Electrical Characteristics Table)
SHOWN ARE:
- 1.1A/6V RATING (LEFT)
- 1.1A/33V RATING (RIGHT)

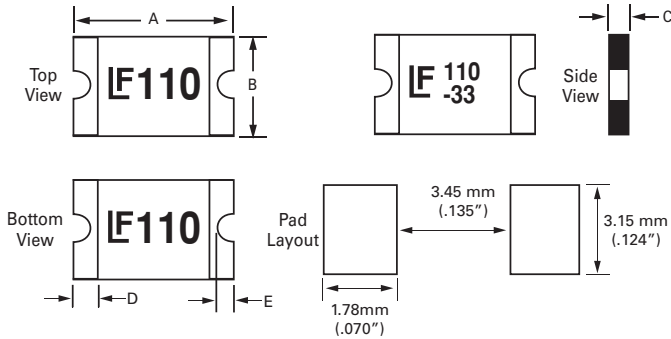

Part Number	A				B				C				D				E			
	Inches		mm		Inches		mm		Inches		mm		Inches		mm		Inches		mm	
	Min	Max	Min	Max	Min	Max	Min	Max	Min	Max	Min	Max	Min	Max	Min	Max	Min	Max	Min	Max
1812L010	0.17	0.19	4.37	4.73	0.12	0.13	3.07	3.41	0.03	0.05	0.75	1.25	0.01	0.05	0.3	1.2	0.01	0.03	0.25	0.65
1812L014	0.17	0.19	4.37	4.73	0.12	0.13	3.07	3.41	0.03	0.08	0.75	1.95	0.01	0.05	0.3	1.2	0.01	0.03	0.25	0.65
1812L020	0.17	0.19	4.37	4.73	0.12	0.13	3.07	3.41	0.02	0.04	0.55	1	0.01	0.05	0.3	1.2	0.01	0.03	0.25	0.65
1812L035/30	0.17	0.19	4.37	4.73	0.12	0.13	3.07	3.41	0.02	0.04	0.6	1.25	0.01	0.05	0.3	1.2	0.01	0.03	0.25	0.65
1812L050	0.17	0.19	4.37	4.73	0.12	0.13	3.07	3.41	0.02	0.03	0.5	0.75	0.01	0.05	0.3	1.2	0.01	0.02	0.25	0.5
1812L050/30	0.17	0.19	4.37	4.73	0.12	0.13	3.07	3.41	0.02	0.04	0.5	1	0.01	0.05	0.3	1.2	0.01	0.03	0.25	0.65
1812L075	0.17	0.19	4.37	4.73	0.12	0.13	3.07	3.41	0.02	0.03	0.5	0.75	0.01	0.05	0.3	1.2	0.01	0.02	0.25	0.5
1812L075/24	0.17	0.19	4.37	4.73	0.12	0.13	3.07	3.41	0.03	0.06	0.75	1.55	0.01	0.05	0.3	1.2	0.01	0.03	0.25	0.65
1812L075/33	0.17	0.19	4.37	4.73	0.12	0.13	3.07	3.41	0.03	0.06	0.75	1.55	0.01	0.05	0.3	1.2	0.01	0.03	0.25	0.65
1812L110	0.17	0.19	4.37	4.73	0.12	0.13	3.07	3.41	0.02	0.03	0.5	0.71	0.01	0.05	0.3	1.2	0.01	0.02	0.25	0.5
1812L110/24	0.17	0.19	4.37	4.73	0.12	0.13	3.07	3.41	0.02	0.04	0.5	1.07	0.01	0.05	0.3	1.2	0.01	0.03	0.25	0.65
1812L110/16	0.17	0.19	4.37	4.73	0.12	0.13	3.07	3.41	0.03	0.05	0.75	1.25	0.01	0.05	0.3	1.2	0.01	0.03	0.25	0.65
1812L110/33	0.17	0.19	4.37	4.73	0.12	0.13	3.07	3.41	0.05	0.08	1.2	2	0.01	0.05	0.3	1.2	0.01	0.03	0.25	0.65
1812L125	0.17	0.19	4.37	4.73	0.12	0.13	3.07	3.41	0.03	0.05	0.75	1.25	0.01	0.05	0.3	1.2	0.01	0.02	0.25	0.5
1812L125/6	0.17	0.19	4.37	4.73	0.12	0.13	3.07	3.41	0.02	0.03	0.45	0.75	0.01	0.05	0.3	1.2	0.01	0.03	0.25	0.65
1812L125/16	0.17	0.19	4.37	4.73	0.12	0.13	3.07	3.41	0.03	0.05	0.75	1.25	0.01	0.05	0.3	1.2	0.01	0.02	0.25	0.5
1812L150	0.17	0.19	4.37	4.73	0.12	0.13	3.07	3.41	0.02	0.03	0.4	0.71	0.01	0.05	0.3	1.2	0.01	0.03	0.25	0.65
1812L150/12	0.17	0.19	4.37	4.73	0.12	0.13	3.07	3.41	0.03	0.05	0.75	1.25	0.01	0.05	0.3	1.2	0.01	0.03	0.25	0.65
1812L150/24	0.17	0.19	4.37	4.73	0.12	0.13	3.07	3.41	0.03	0.07	0.8	1.8	0.01	0.05	0.3	1.2	0.01	0.03	0.25	0.65
1812L160	0.17	0.19	4.37	4.73	0.12	0.13	3.07	3.41	0.02	0.03	0.4	0.75	0.01	0.05	0.3	1.2	0.01	0.03	0.25	0.65
1812L160/12	0.17	0.19	4.37	4.73	0.12	0.13	3.07	3.41	0.03	0.05	0.75	1.25	0.01	0.05	0.3	1.2	0.01	0.03	0.25	0.65
1812L200TH	0.17	0.19	4.37	4.73	0.12	0.13	3.07	3.41	0.008	0.024	0.2	0.6	0.01	0.05	0.3	1.2	0.01	0.02	0.25	0.5
1812L260TH	0.17	0.19	4.37	4.73	0.12	0.13	3.07	3.41	0.02	0.04	0.5	1.0	0.01	0.05	0.3	1.2	0.01	0.02	0.25	0.5
1812L260/12	0.17	0.19	4.37	4.73	0.12	0.13	3.07	3.41	0.03	0.05	0.8	1.34	0.01	0.05	0.3	1.2	0.01	0.03	0.25	0.65
1812L300	0.17	0.19	4.37	4.73	0.12	0.13	3.07	3.41	0.03	0.06	0.8	1.50	0.01	0.05	0.3	1.2	0.01	0.03	0.25	0.65

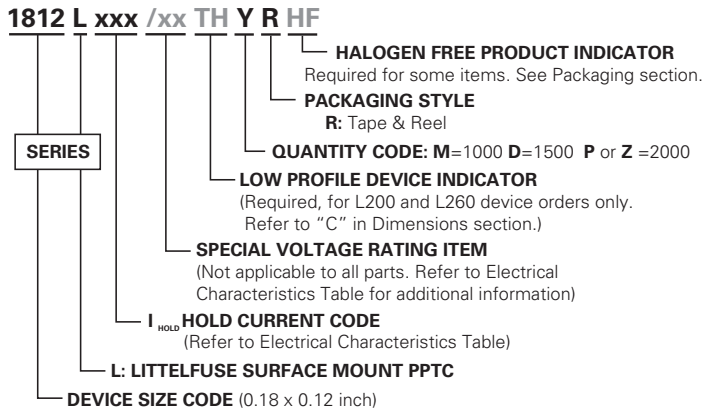
Part Ordering Number System

Packaging

Part Number	Ordering Number	Halogen Free*	I _{hold} (A)	I _{hold} Code	Voltage Option	Packaging Option	Quantity	Quantity & Packaging Code
1812L010	1812L010DRHF	Yes	0.10	010		Tape and Reel	1500	DR
	1812L010DR	No						
1812L014	1812L014DRHF	Yes	0.14	014			1500	DR
	1812L014DR	No						
1812L020	1812L020PRHF	Yes	0.20	020			2000	PR
	1812L020PR	No						
1812L035/30	1812L035/30DR	Yes	0.35	035	/30		1500	DR
1812L050	1812L050PRHF	Yes	0.50	050			2000	PR
	1812L050PR	No						
1812L050/30	1812L050/30PR	Yes	0.50	050	/30		2000	PR
1812L075	1812L075PRHF	Yes	0.75	075			2000	PR
	1812L075PR	No						
1812L75/24	1812L075/24DRHF	Yes	0.75	075	/24		1500	DR
	1812L075/24DR	No						
1812L75/33	1812L075/33DRHF	Yes	0.75	075	/33		1500	DR
	1812L075/33DR	No						
1812L110	1812L110PRHF	Yes	1.10	110			2000	PR
	1812L110PR	No						
1812L110/16	1812L110/16DRHF	Yes	1.10	110	/16		1500	DR
	1812L110/16DR	No						
1812L110/24	1812L110/24DR	Yes	1.10	1.10	/24		1500	DR
1812L110/33	1812L110/33MRHF	Yes	1.10	110	/33		1000	MR
	1812L110/33MR	No						
1812L125	1812L125DRHF	Yes	1.25	125			1500	DR
	1812L125DR	No						
1812L125/6	1812L125/6PRHF	Yes	1.25	125	/6		2000	PR
	1812L125/6PR	No						
1812L125/16	1812L125/16DR	Yes	1.25	125	/16		1500	DR
1812L150	1812L150ZR	No	1.50	150		2000	ZR	
	1812L150ZRHF	Yes						
1812L150/12	1812L150/12DRHF	Yes	1.50	150	/12	1500	DR	
	1812L150/12DR	No						
1812L150/24	1812L150/24MRHF	Yes	1.50	150	/24	1000	MR	
	1812L150/24MR	No						
1812L160	1812L160PRHF	Yes	1.60	160		2000	PR	
	1812L160PR	No						
1812L160/12	1812L160/12DRHF	Yes	1.60	160	/12	1500	DR	
	1812L160/12DR	No						
1812L200TH	1812L200THPR	Yes	2.00	200		2000	PR	
1812L260TH	1812L260THDR	Yes	2.60	260		1500	DR	
1812L260/12	1812L260/12MR	Yes	2.60	260	/12	1000	MR	
1812L300	1812L300MR	Yes	3.00	300		1000	MR	

* Effective September 15, 2009 onward, all 1812L PTC products will be manufactured Halogen Free (HF). Existing Non-Halogen Free 1812L PTC products will continue to be sold until supplies are depleted. Effective January 1, 2010, all 1812L PTC product will be manufactured and sold as Halogen Free by default, and "HF" part number suffix code will be discontinued.

Tape and Reel Specifications

TAPE SPECIFICATIONS: EIA-481-1 (mm)			
	1812L020 1812L035/30 1812L050 1812L075 1812L110 1812L125/6 1812L150 1812L160 1812L200TH	1812L010 1812L014 1812L050/30 1812L075/24 1812L075/33 1812L110/16 1812L110/24 1812L125 1812L125/16 1812L150/12 1812L160/12 1812L260TH	1812L110/33 1812L150/24 1812L260/12 1812L300
W	12.00+0.30-0.10	12.00+/-0.30	12.00+/-0.30
F	5.50+/-0.05	5.50+/-0.05	5.50+/-0.05
E₁	1.75+/-0.10	1.75+/-0.10	1.75+/-0.10
D₀	1.50+0.10	1.55+/-0.05	1.55+/-0.05
D₁	1.50+0.25	1.50 (MIN)	1.50 (MIN)
P₀	4.00+/-0.10	4.00+/-0.10	4.00+/-0.10
P₁	8.00+/-0.10	8.00+/-0.10	8.00+/-0.10
P₂	2.00+/-0.05	2.00+/-0.05	2.00+/-0.05
A₀	3.58+/-0.10	3.58+/-0.10	3.58+/-0.10
B₀	4.93+/-0.10	4.93+/-0.10	4.93+/-0.10
T	0.25+/-0.10	0.25+/-0.10	0.25+/-0.10
K₀	0.87+/-0.06	1.25+/-0.10	2.10+/-0.10
Leader min.	390	390	390
Trailer min.	160	160	160

**REEL DIMENSIONS:
EIA-481-1 (mm)**

H	16.0+/-0.2
W	13.2+/-1.5
D	Ø60.2+/-0.5
F	Ø13.0+/-0.5
C	Ø178+/-1.0
H₁	11+/-0.5
W₁	2.5+0.5
W₂	3.0+0.5
W₃	4.0+0.5
W₄	5.0+0.5

