

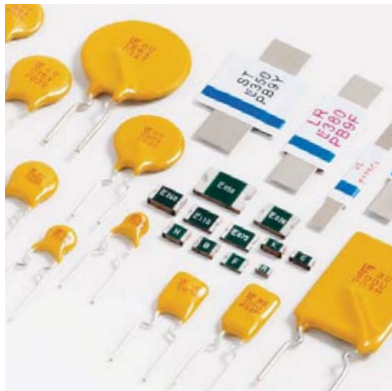

Expertise Applied | Answers Delivered



PRODUCT
CATALOG
& DESIGN
GUIDE



PTC

Positive Temperature Coefficient
(PTC) Thermistor Products

Littelfuse Circuit Protection Solutions Portfolio

Consumer Electronics | Telecom | White Goods | Medical Equipment | TVSS and Power Solutions

DESIGN SUPPORT

Live Application Design and Technical Support—Tap into our expertise. Littelfuse engineers are available around the world to help you address design challenges and develop unique, customized solutions for your products.

Product Sampling Programs—Most of our products are available as samples for testing and verification within your circuit design. Visit Littelfuse.com or contact a Littelfuse product representative for additional information.

Product Evaluation Labs and Services—Littelfuse global labs are the hub of our new product development initiatives, and also provide design and compliance support testing as an added-value to our customers.



OVERVOLTAGE SUPPRESSION TECHNOLOGIES (1-6)

1. TVS Diodes — Suppress overvoltage transients such as Electrical Fast Transients (EFT), inductive load switching and lightning in a wide variety of applications in the computer, industrial, telecom and automotive markets.

2. Varistors — Multiple forms, from Metal Oxide Varistors (MOVs) that suppress transient voltages to Multi-Layer Varistors (MLVs) designed for applications requiring protection from various transients in computers and handheld devices as well as industrial and automotive applications.

3. SIDACtor® Devices — Complete line of protection thyristor products specifically designed to suppress overvoltage transients in a broad range of telecom and datacom applications.

4. Gas Plasma Arrestors (GDTs) — Available in small footprint leaded and surface mount configurations, Littelfuse GDTs respond fast to transient overvoltage events, reducing the risk of equipment damage.

5. Silicon Protection Arrays — Designed specifically to protect analog and digital signal lines from electrostatic discharge (ESD) and other overvoltage transients.

6. PulseGuard® ESD Suppressors — Available in various surface mount form factors to protect high-speed digital lines without causing signal distortion.

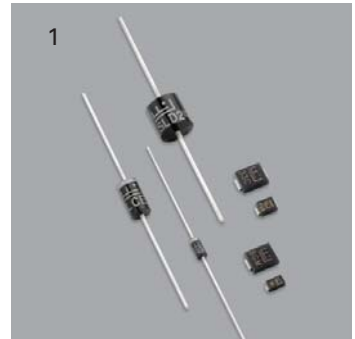

Visit

Protection folio

Supplies | Lighting | General Electronics

SWITCHING TECHNOLOGIES

Switching Thyristors— Solid-state switches used to control the flow of electrical current in applications, capable of withstanding rated blocking/off-state voltage until triggered to on-state.

ACCESSORIES

In addition to our broad portfolio of circuit protection technologies, we offer an array of **fuse holders** including circuit board, panel or in-line wire mounted devices to support a wide range of application requirements.

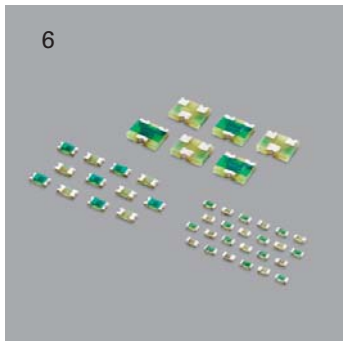
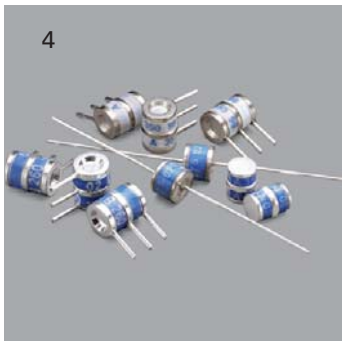
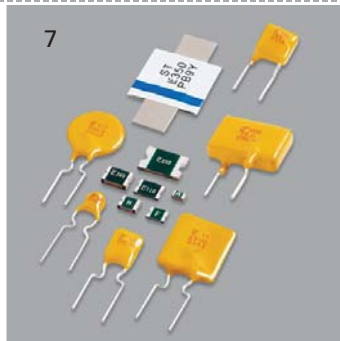
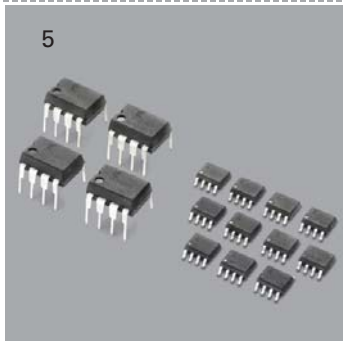
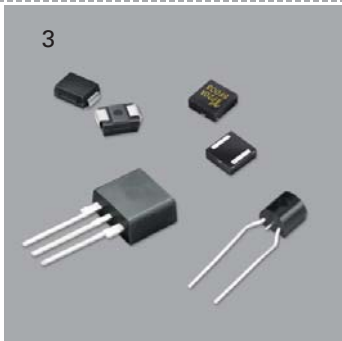
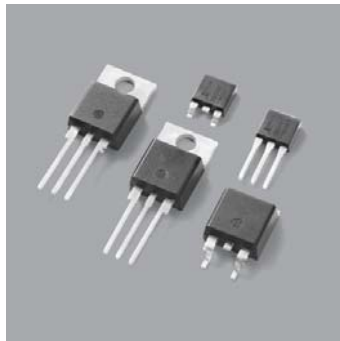

OVERCURRENT PROTECTION TECHNOLOGIES (7-8)

7. Positive Temperature Coefficient Devices (PTCs)— Provide resettable overcurrent protection for a wide range of applications.

8. Fuses— Full range including surface mount, axial, glass or ceramic, thin-film or Nano²⁰ style, fast-acting or SloBlo[®], MINI[®] and ATO[®] fuses.

www.littelfuse.com for more information.



Positive Temperature Coefficient Thermistors (PTCs)

Littelfuse PTCs offer a resettable over-current protection alternative.

Ideal for situations where frequent over-current conditions occur or constant uptime is required, PTCs are typically used in consumer electronics, power line, telecom, I/O port, process control and medical equipment protection applications.



















PTCs increase resistance as temperature increases due to increased current flow. Designed to limit unsafe currents while allowing constant safe current levels, resistance will "reset" automatically when the fault is removed and temperature returns to a safe level.

















Features











- Fast and automatically resettable protection against fault currents
- Low operating resistance
- RoHS compliant, lead-free, and UR and TUV certified
- Available in a range of compact surface-mount, radial lead and battery strap options
- Hold Current (I_{HOLD}) options spanning 0.05 - 14A
- Max Voltage (V_{MAX}) options spanning 6 - 60V
- Maximum Fault Current options spanning 10 - 100 A

TABLE OF CONTENTS

Introduction		
PTC Selection Worksheet & Product Tables		2 - 3
PTC Characteristics and Terms		4 - 5
PTC Applications		6 - 7

Data Sheets: Surface Mount PTCs		
  	0603L Series , 0603 Size, 0.10 – 0.35A (I_{hold})	9
 	0805L Series , 0805 Size, 0.10 – 1.0A (I_{hold})	15
 	1206L Series , 1206 Size, .125 – 1.50A (I_{hold})	21
 	1210L Series , 1210 Size, 0.05 – 1.50A (I_{hold})	27
 	1812L Series , 1812 Size, 0.10 – 2.60A (I_{hold})	33
 	2016L Series , 2016 Size, 0.30 – 2.0A (I_{hold})	39
 	2920L Series , 2920 Size, 0.30 – 3.0A (I_{hold})	45
  	250S Series , 0.13A (I_{hold})	51

Data Sheets: Radial Leaded PTCs		
 	USBR Series , 0.75 – 2.50A (I_{hold})	57
  	16R Series , 2.50 – 14.0A (I_{hold})	63
 	30R Series , 0.90 – 9.0A (I_{hold})	71
 	60R Series , 0.10 – 3.75A (I_{hold})	79
  	72R Series , 0.20 – 3.75A (I_{hold})	87
 	250R Series , 0.08 – 0.18A (I_{hold})	95
 	600R Series , 0.15 – 0.16A (I_{hold})	103

Data Sheets: Battery Strap PTCs		
 	LR Series , 1.90 – 7.30A (I_{hold})	111
 	LT Series , 0.70 – 3.40A (I_{hold})	115
 	ST Series , 1.20 – 1.75A (I_{hold})	119
 	VL Series , 1.70 – 2.30A (I_{hold})	123
 	VT Series , 1.70 – 2.40A (I_{hold})	127

PTC Selection Worksheet

1. Define the circuit operating parameters.

- Normal operating current in amperes:
- Normal operating voltage in volts:
- Maximum interrupt current:
- Ambient temperature:
- Typical overload current:
- Required opening time at specified overload:
- Transient pulses expected:
- Agency approvals:
- Mounting type/form factor:
- Typical resistance (in circuit):

2. Select the proper circuit protection component.

(Refer to Table on Page 3 and specifications with Data Sheets)

3. Determine the opening time at fault.

Consult the Time-Current (T-C) Curve of each PTC series to determine if the selected part will operate within the constraints of your application.

If the device opens too soon, the application may experience nuisance operation. If the device does not open soon enough, the overcurrent may damage downstream components.

To determine the opening time for the chosen device, locate the overload current on the X-axis of the appropriate T-C Curve and follow its line up to its intersection with the curve. At this point read the time tested on the Y-axis. This is the average opening time for that device.

If your overload current falls to the right of the curve the device will open. If the overload current is to the left of the curve, the device will not operate.

4. Verify ambient operating parameters.





Ensure that the application voltage is less than or equal to the device's rated voltage and that the operating temperature limits are within those specified by the device.





5. Verify the device's dimensions.



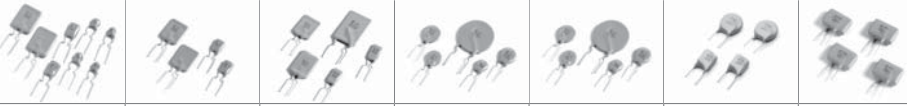

Compare the maximum dimensions of the device to the space available in the application. The dimension of each product is included within each data sheets on the following pages.

6. Test the selected product in an actual application.

PTC Selection Tables

Type	Surface Mount							
Series	0603L	0805L	1206L	1210L	1812L	2016L	2920L	250S
Page #	9	15	21	27	33	39	45	51
Photo								
Chip Size	0603 (1608)	0805 (2012)	1206 (3216)	1210 (3225)	1812 (4532)	2016 (5041)	2920 (7351)	
Hold Current (I_{HOLD})	0.10 - 0.35 A	0.10 - 1.00 A	0.125 - 1.50 A	0.05 - 1.50 A	0.10 - 2.60 A	0.30 - 2.00 A	0.30 - 3.00 A	0.13A
Max Voltage (V_{MAX})	6 - 15 V	6 - 15 V	6 - 30 V	6 - 30 V	6 - 60 V	6 - 60 V	6 - 60 V	60 V
Max Fault Current (I_{MAX})	40 A	40 / 100 A	100 A	10 / 100 A	10 / 20 / 100 A	20 / 40 A	10 / 40 A	3 A
Operating Temperature Range	-40°C to 85°C							
Agency Approval								
 RoHS Compliant	YES							
 Lead-Free	YES							

Type	Radial Leaded						
Series	USBR	16R	30R	60R	72R	250R	600R
Page #	57	63	71	79	87	95	103
Photo							
Hold Current (I_{HOLD})	0.75 - 2.50 A	2.50 - 14.00 A	0.90 - 9.00 A	0.10 - 3.75 A	0.20 - 3.75 A	0.08 - 0.18 A	0.15 - 0.16 A
Max Voltage (V_{MAX})	6 / 16V	16 V	30V	60 V	72 V	60 V	60 V
Max Fault Current (I_{MAX})	40 A	100 A	40 A	40 A	40 A	3 / 10 A	3 A
Operating Temperature Range	-40°C to 85°C						
Agency Approval							
 RoHS Compliant	YES						
 Lead-Free	YES						

Type	Battery Strap				
Series	LR	LT	ST	VL	VT
Page #	111	115	119	123	127
Photo					
Hold Current (I_{HOLD})	1.90 - 7.30 A	0.70 - 3.40 A	1.20 - 1.75 A	1.70 - 2.30 A	1.70 - 2.40 A
Max Voltage (V_{MAX})	15 / 20V	15 / 24V	15 V	12 V	16 V
Max Fault Current (I_{MAX})	100A				
Operating Temperature Range	-40°C to 85°C				
Agency Approval					
 RoHS Compliant	YES				
 Lead-Free	YES				

Introduction

Overcurrent circuit protection can be accomplished with the use of either a traditional fuse or PTC (positive temperature coefficient) device.

PTCs are typically used in a wide variety of telecom, computer, consumer electronics, battery and medical electronics product applications where overcurrent events are common and automatic resettability desired.

Littelfuse offers PTCs with the following general forms and features, and come in a variety of sizes and capacities:

Surface Mount Devices:

- A full range of compact footprints
- Low hold current
- Very fast trip time
- Low resistance

Radial Leaded Series:

- Protection devices up to 600Vdc
- A very high hold current
- Low trip-to-hold current ratio
- Low resistance.

Battery Strap Devices:

- A narrow low profile design
- A weldable band Nickel terminal
- Low resistance—for extended battery run time

If your application requirements fall outside of our product range, in certain instances we can offer customized solutions. Please contact Littelfuse for more information.

Traditional Fuses Vs. PTCs

Fuses and PTCs are both overcurrent protection devices, though each offer their own unique operating characteristics and benefits. Understanding the differences between the two technologies should make the choice in selection easier, depending on the application.

The most obvious difference is that PTCs are automatically resettable whereas traditional Fuses need to be replaced after they they are tripped. Whereas a fuse will completely stop the flow of current (which may be desired in critical applications) after most similar overcurrent event, PTCs continue to enable the equipment to function, except in extreme cases.

Because they reset automatically, many circuit designers choose PTCs in instances where overcurrent events are expected to occur often, and where maintaining low warranty and service costs, constant system uptime, and/or user transparency are at a premium. They are also often chosen in circuits that are difficult to access in or remote locations, were fuse replacement would be difficult.

There are several other operating characteristics to be considered that distinguish PTCs and fuses, and it is also best to test and verify device performance before use within the end application.

Littelfuse PTC Characteristics

Both Polymeric (Positive Temperature Coefficient) PTC and traditional Fuse devices react to heat generated by the excessive current flow in a circuit. A fuse melts open, interrupting the current flow whereas a PTC limits current flow as it rises in temperature, changing from low to high resistance state. In both cases this condition is called "tripping." The graph at right shows the typical response of a PTC to temperature.

Littelfuse Polymer PTCs are made chiefly of high density polyethylene mixed with graphite. During an overcurrent event, a Polymer PTC will heat and expand, which in turn causes the conducting particles to break contact and stop the current.

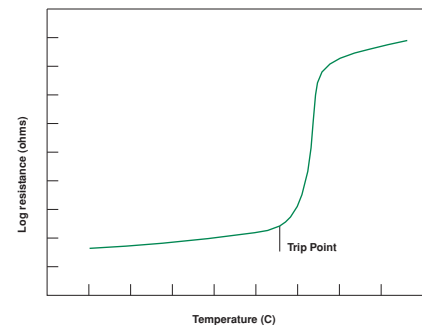

The general procedure for resetting the device after an overload has occurred is to remove power and allow the device to cool down.

Leakage Current: When a PTC is in a "tripped state" it protects the circuitry by limiting the current flow to a low leakage level. Leakage current can range from less than a hundred milliamps (mA) at rated voltage up to a few hundred milliamps (mA) at lower voltages. Fuses on the other hand completely interrupt the current flow when tripped, and this open circuit results in no leakage current when subjected to an overload current.

Interrupting Rating: PTCs are rated for a maximum short circuit current at rated voltage also known as "breaking capacity" or I_{max} . This fault current level is the maximum current that the device can withstand safely, keeping in mind that the PTC will not actually interrupt the current flow (see Leakage Current above). A typical Littelfuse PTC short circuit rating is 40A; or for the battery strap PTCs, this value can reach 100A. Fuses do in fact interrupt the current flow in response to the overload and the range of interrupting ratings, vary from tens of amperes (A) up to 10,000 (A) amperes at rated voltage.

Operating Voltage Rating: General use Littelfuse PTCs are not rated above 60V while fuses are rated up to 600V.

Hold Current Rating: The hold (operating) current rating for PTCs can be up to 14A, while the maximum level for fuses can exceed 30A.

Resistance: Reviewing product specifications indicates that similarly rated PTCs have about twice (sometimes more) the resistance of fuses.

Agency Approvals: Littelfuse PTCs are Recognized under the Component Program of Underwriters Laboratories to UL Standard 1434 for Thermistors. The devices have also been certified under the CSA Component Acceptance Program. Approvals for fuses include Recognition under the Component Program of Underwriters Laboratories and the CSA Component Acceptance Program. In addition, many fuses are available with full "Listing" in accordance with the new Supplementary Fuse Standard UL/CSA/ANCE (Mexico) 248-14. Supplemental fuses.

Time-Current Characteristic: Comparing the time-current curves of PTCs to time-current curves of fuses show that the speed of response for a PTC is similar to the time delay of a Slo-Blo® fuse.

Temperature Rerating: The useful upper limit for a PTC is generally 85°C, while the maximum operating temperature for fuses is 125°C.

Ambient temperature effects are in addition to the normal rerating. PTCs hold and trip rating must be rerated when applied at conditions other than room ambient. For example, any rise in ambient temperature will decrease the hold current rating as well as the trip current. A reduction in ambient temperature will increase the trip current as well as the hold current.

The temperature rerating curves in the table below compare PTCs to fuses and illustrate that more rerating is required for a PTC at a given temperature.

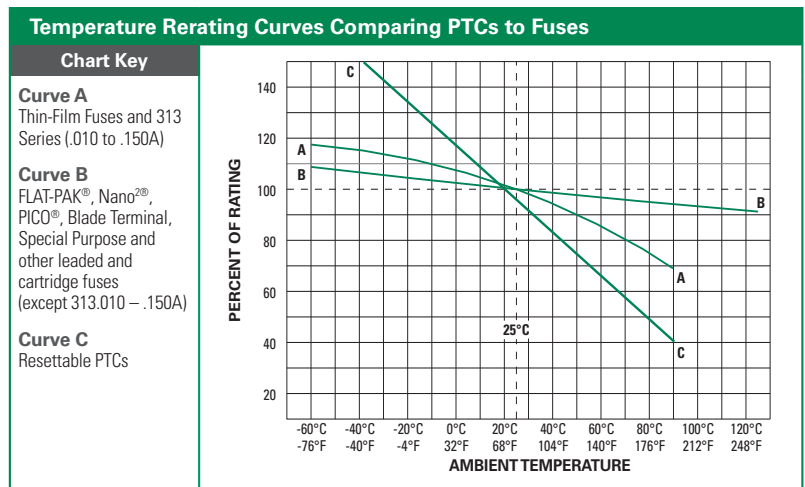

PTC Product Applications

PTCs are typically used as circuit protection in applications where sensitive components are at constant risk of damage from overcurrent conditions. The ability of PTCs to reset themselves after exposure to a fault current makes them ideal within circuits that are not easily accessible to a user or technician or where constant uptime is required.

Typical applications include port protection on personal computers (USB, Firewire, keyboard/mouse, and serial ports), peripherals (hard drives, video cards, and hubs), cell phone, battery packs, industrial controls, lighting ballast and motor controls.

The chart below is meant as a quick guide in narrowing to a Littelfuse PTC device that may be appropriate to certain end applications.

For detailed application assistance please contact a Littelfuse product specialist or visit our new reference design center at <http://www.littelfuse.com/designcenter>.

For detailed product specifications, please consult the Littelfuse PTC datasheets within this Catalog or visit <http://www.littelfuse.com/PTCs>.

Series Name	SURFACE MOUNT							RADIAL LEADED						BATTERY STRAP						
	0603L	0805L	1206L	1210L	1812L	2016L	2920L	250S	USBR	16R	30R	60R	72R	250R	600R	LR	LT	ST	VL	VT
Application																				
UI60950, TIA-968-A, GR-1089 Req's								X						X	X					
ITU-T Recommendations								X						X	X					
CPE (Customer Premises Equipment)								X						X	X					
Analog Line Card								X						X	X					
T1/E1/J1 And HDSL								X						X	X					
ISDN								X						X	X					
ADSL								X						X	X					
Cable Telephony								X						X	X					
PBX/KTS And Key Telephone System								X						X	X					
Computer							X		X	X										
CPU							X		X	X										
USB	X	X	X	X	X				X	X										
IEEE1284 Parallel Data Bus			X	X	X				X	X										
IEEE 802.3						X	X						X	X						
IEEE 1394					X		X				X									
I/O Ports			X	X	X		X		X	X										
PC Card	X	X	X	X	X		X		X	X										
SCSI			X	X	X		X		X	X										
Video Port			X	X	X		X		X	X										
LCD Monitor	X	X	X	X	X				X	X										
Consumer Electronics																				
Set Top Box			X	X	X		X													
Loudspeaker											X									
Smart Card Reader			X																	
Mobile Phone	X	X	X	X																
Linear AC/DC Adapter	X	X	X	X	X		X				X	X	X							
Portable Electronic Input Port	X	X	X	X	X	X														
Electromagnetic Loads, Motor						X	X				X	X	X							
Solenoid Protection					X		X				X	X	X							
Battery																				
Lithium Cell																X	X	X	X	X
Battery Pack																X	X	X	X	X
Medical electronic																				
Voltage / Current Input Terminal			X		X															

NOTE: The application summary is for reference only. Determination of suitability for a specific application is the responsibility of the customer.

Typical PTC Circuit Protection Designs

The following are examples of typical circuits using Littelfuse PTCs in combination with other Littelfuse circuit protection devices to provide a comprehensive protection solution. Contact a Littelfuse application expert for design

assistance or visit www.littelfuse.com/designcenter or <http://www.littelfuse.com/PTCs> for additional information. Be sure to verify specifications and test device performance before use in the end application.

POWER OVER ETHERNET

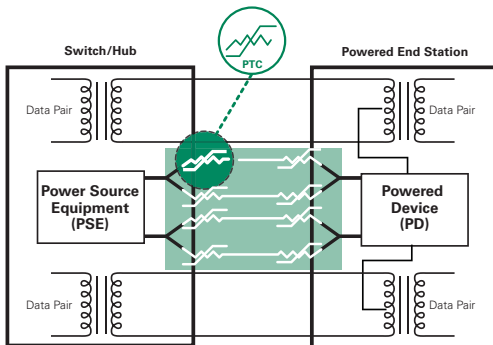

LI-ION BATTERY PACK

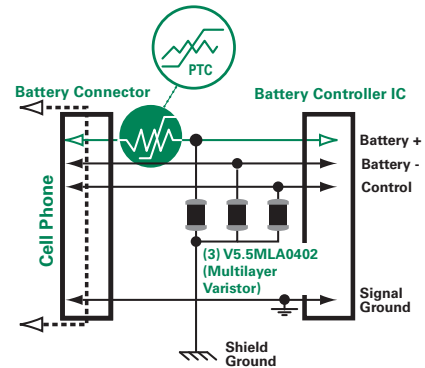

USB 1.1

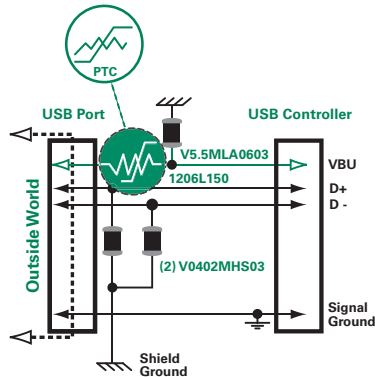

USB 2.0

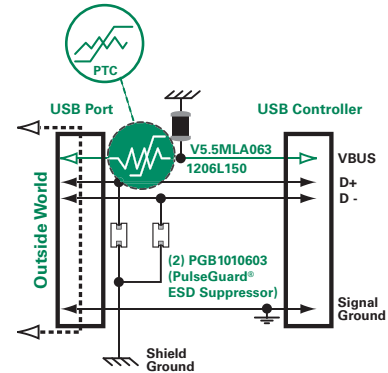

IEEE 1394 - FIREWIRE

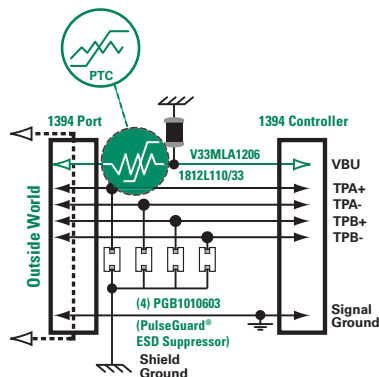

TIP/RING CIRCUIT - METALLIC

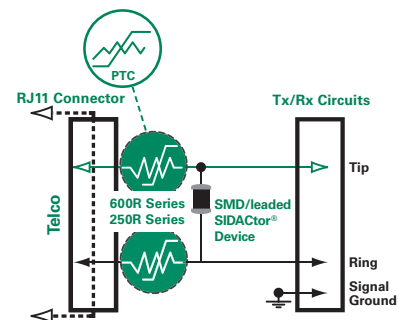

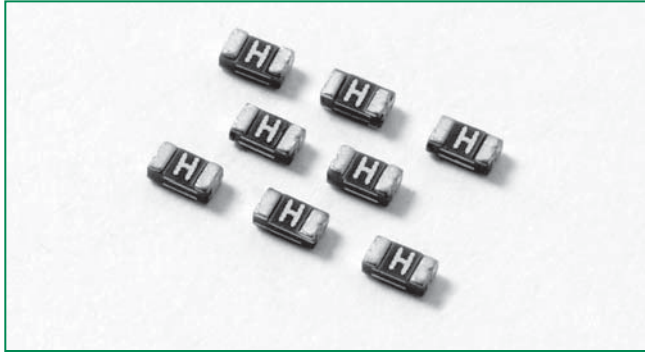



Description

The new 0603L Series PTC provides surface mount overcurrent protection for applications where space is at a premium and resettable protection is desired.

Features

- RoHS compliant and lead-free
- Fast response to fault currents
- Compact design saves board space
- Low resistance
- Low-profile
- Compatible with high temperature solders



Agency Approvals

AGENCY	AGENCY FILE NUMBER
	E183209
	R50119118

Applications

- USB peripherals
- Disk drives
- CD-ROMs
- Plug and play protection for motherboards and peripherals
- PDAs / digital cameras
- Game console port protection

Electrical Characteristics

Part Number	Marking	I_{hold} (A)	I_{trip} (A)	V_{max} (Vdc)	I_{max} (A)	P_d max. (W)	Maximum Time To Trip		Resistance		Agency Approvals	
							Current (A)	Time (Sec.)	R_{min} (Ω)	R_{1max} (Ω)		
0603L010	C	0.10	0.30	15	40	0.5	0.50	1.00	0.900	6.000	X	X
0603L020	H	0.20	0.50	9	40	0.5	1.00	0.60	0.550	3.500	X	X
0603L025	I	0.25	0.55	9	40	0.5	8.00	0.08	0.500	3.000	X	X
0603L035	F	0.35	0.75	6	40	0.5	8.00	0.10	0.200	1.000	X	X

I_{hold} = Hold current: maximum current device will pass without tripping in 20°C still air.

I_{trip} = Trip current: minimum current at which the device will trip in 20°C still air.

V_{max} = Maximum voltage device can withstand without damage at rated current (I_{max})

I_{max} = Maximum fault current device can withstand without damage at rated voltage (V_{max})

P_d = Power dissipated from device when in the tripped state at 20°C still air.

R_{min} = Minimum resistance of device in initial (un-soldered) state.

R_{1max} = Maximum resistance of device at 20°C measured one hour after tripping or reflow soldering of 260°C for 20 sec.

Caution: Operation beyond the specified rating may result in damage and possible arcing and flame.

Temperature Derating

Part Number	Ambient Operation Temperature								
	-40°C	-20°C	0°C	23°C	40°C	50°C	60°C	70°C	85°C
0603L010	0.13	0.12	0.11	0.10	0.08	0.07	0.06	0.05	0.03
0603L020	0.27	0.25	0.23	0.20	0.17	0.14	0.12	0.10	0.07
0603L025	0.32	0.29	0.27	0.25	0.21	0.18	0.16	0.14	0.10
0603L035	0.47	0.41	0.38	0.35	0.29	0.26	0.24	0.20	0.14

Average Time Current Curves

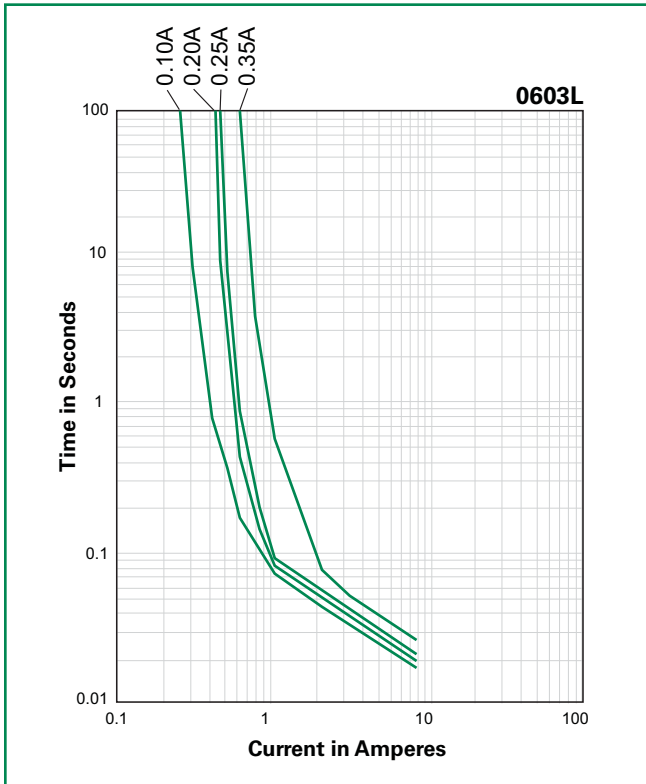

Temperature Derating Curve

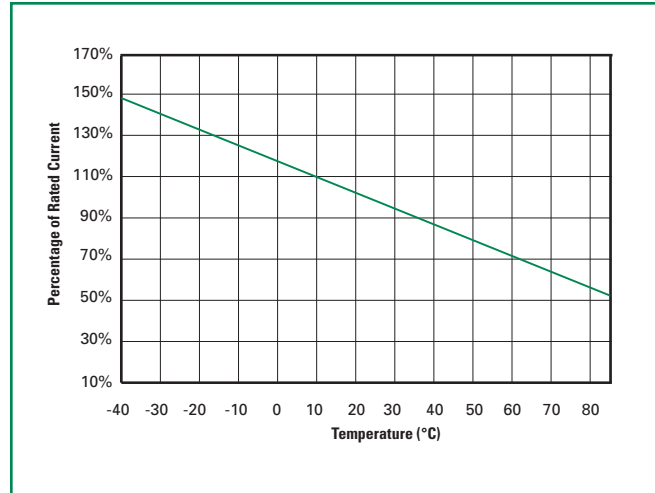

The average time current curves and Temperature Derating curve performance is affected by a number of variables, and these curves provided as guidance only. Customer must verify the performance in their application.

Soldering Parameters

Profile Feature		Pb-Free Assembly
Average Ramp-Up Rate ($T_{S(max)}$ to T_p)		3°C/second max
Pre Heat:	Temperature Min ($T_{s(min)}$)	150°C
	Temperature Max ($T_{s(max)}$)	200°C
	Time (Min to Max) (t_s)	60 – 180 secs
Time Maintained Above:	Temperature (T_L)	217°C
	Temperature (t_L)	60 – 150 seconds
Peak / Classification Temperature (T_p)		260 ^{+0/-5} °C
Time within 5°C of actual peak Temperature (t_p)		20 – 40 seconds
Ramp-down Rate		6°C/second max
Time 25°C to peak Temperature (T_p)		8 minutes Max.

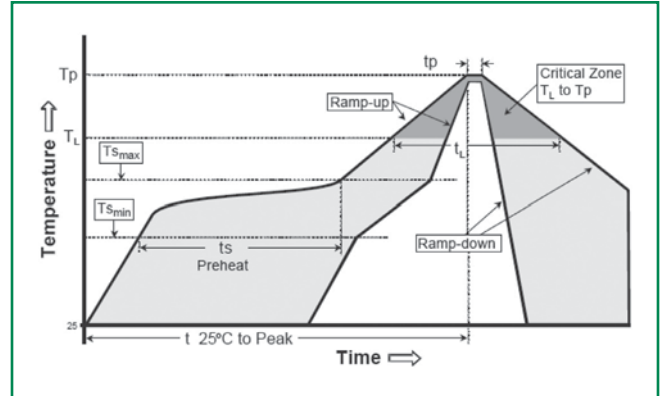

- All temperature refer to topside of the package, measured on the package body surface
- If reflow temperature exceeds the recommended profile, devices may not meet the performance requirements
- Recommended reflow methods: IR, vapor phase oven, hot air oven, N₂ environment for lead
- Recommended maximum paste thickness is 0.25mm (0.010inch)
- Devices can be cleaned using standard industry methods and solvents
- Devices can be reworked using the standard industry practices

Physical Specifications

Terminal Material	Solder-Plated Copper (Solder Material: Matte Tin (Sn))
Lead Solderability	Meets EIA Specification RS186-9E, ANSI/J-STD-002, Category 3.

Environmental Specifications

Operating/Storage Temperature	-40°C to +85°C
Maximum Device Surface Temperature in Tripped State	125°C
Passive Aging	+85°C, 1000 hours -/+10% typical resistance change
Humidity Aging	+85°C, 85% R.H., 100 hours -/+15% typical resistance change
Thermal Shock	MIL-STD-202, Method 107G +85°C/-40°C 20 times -30% typical resistance change
Solvent Resistance	MIL-STD-202, Method 215 No change
Vibration	MIL-STD-883C, Method 2007.1, Condition A No change
Moisture Sensitivity Level	Level 2, J-STD-020C

Dimensions

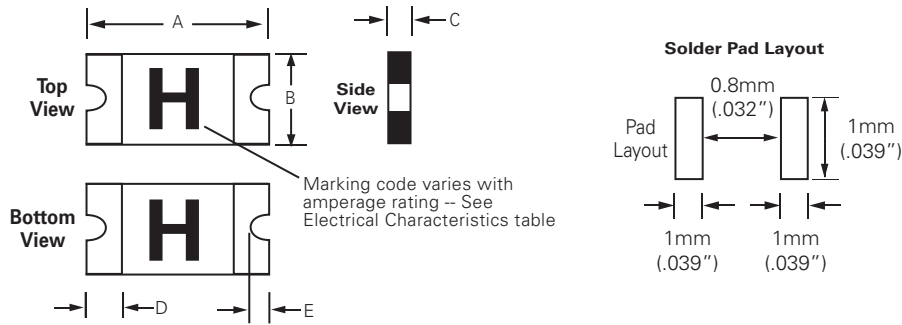

Part Number	A				B				C				D				E			
	Inch		mm		Inch		mm		Inch		mm		Inch		mm		Inch		mm	
	Min	Max	Min	Max	Min	Max	Min	Max	Min	Max	Min	Max	Min	Max	Min	Max	Min	Max	Min	Max
0603L010	.055	.071	1.40	1.80	.024	.039	0.60	1.00	.016	.030	0.40	0.75	.006	.020	0.15	0.50	.004	.016	0.10	0.40
0603L020	.055	.071	1.40	1.80	.024	.039	0.60	1.00	.016	.030	0.40	0.75	.006	.020	0.15	0.50	.004	.016	0.10	0.40
0603L025	.055	.071	1.40	1.80	.024	.039	0.60	1.00	.016	.030	0.40	0.75	.006	.020	0.15	0.50	.004	.016	0.10	0.40
0603L035	.055	.071	1.40	1.80	.024	.039	0.60	1.00	.030	.061	0.75	1.55	.006	.020	0.15	0.50	.004	.016	0.10	0.40

Part Ordering Number System

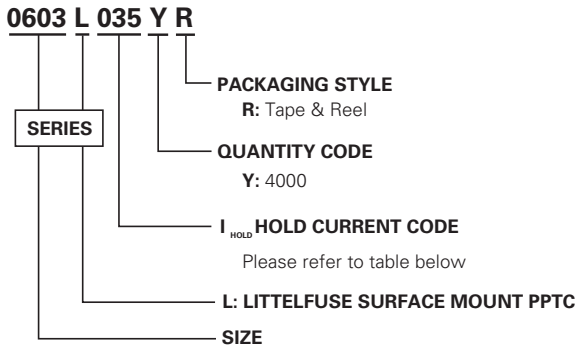

Packaging

Part Number	Ordering Number	I_{hold} (A)	I_{hold} Code	Packaging Option	Quantity	Quantity & Packaging Codes
0603L010	0603L010YR	0.10	010	Tape and Reel	4000	YR
0603L020	0603L020YR	0.20	020	Tape and Reel	4000	YR
0603L025	0603L025YR	0.25	025	Tape and Reel	4000	YR
0603L035	0603L035YR	0.35	035	Tape and Reel	4000	YR

Tape and Reel Specifications

TAPE SPECIFICATIONS: EIA-481-1 (mm)		
	0603L010 0603L020 0603L025	0603L035
W	8.0+/- 0.30	8.0+/- 0.30
F	3.5+/- 0.05	3.5+/- 0.05
E₁	1.75+/- 0.10	1.75+/- 0.10
D₀	1.55+/- 0.05	1.55+/- 0.05
D₁	0.5(min)	0.5 (min)
P₀	4.0+/- 0.10	4.0+/- 0.10
P₁	4.0+/- 0.10	4.0+/- 0.10
P₂	2.0+/- 0.05	2.0+/- 0.05
A₀	1.10+/- 0.10	1.10+/- 0.10
B₀	1.92+/- 0.10	1.92+/- 0.10
T	0.20+/- 0.10	0.20+/- 0.10
K₀	0.72+/- 0.10	0.96+/- 0.10
Leader min.	390	390
Trailer min.	160	160

REEL DIMENSIONS: EIA-481-1 (mm)	
H	12.0+/- 0.05
W	9.0+/- 0.5
D	Ø60+0.5
F	Ø13.0 +/- 0.2
C	Ø178 +/- 1.0
H₁	11+/- 0.5
W₁	2.2+/- 0.5
W₂	3.0+0.5
W₃	4.0+0.5
W₄	5.5+0.5

0603L Series

Tape and Reel Diagram

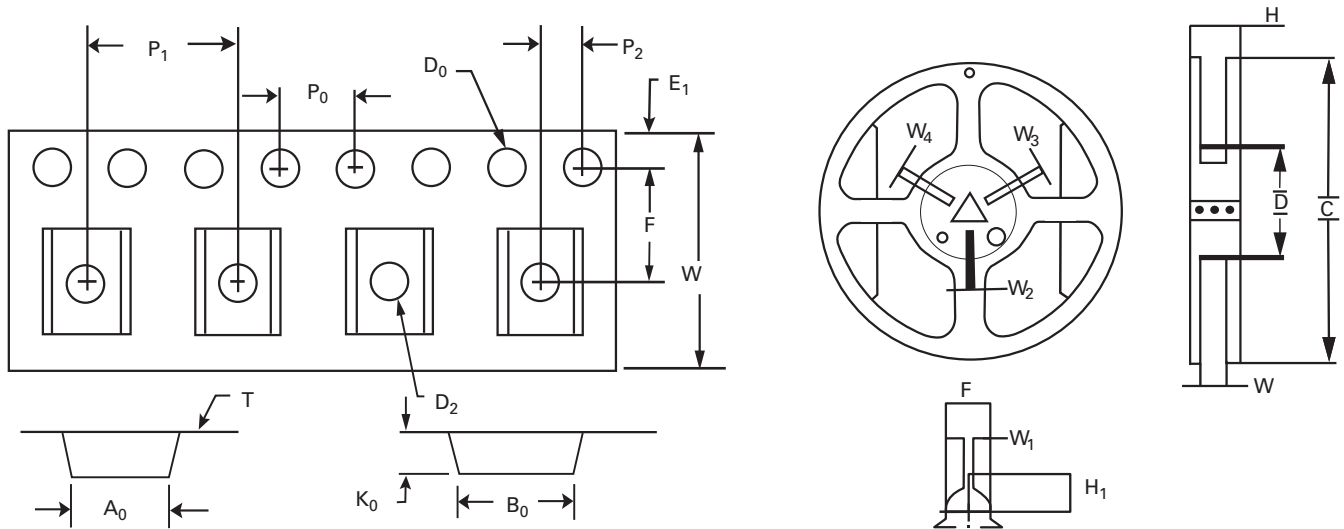



Description

The 0805L Series device provides surface mount overcurrent protection for applications where space is at a premium and resettable protection is desired.



Features

- RoHS compliant and lead-free
- Fast response to fault currents
- Compact design saves board space
- Low resistance
- Low-profile
- Compatible with high temperature solders



Applications

- USB peripherals
- Disk drives
- CD-ROMs
- Plug and play protection for motherboards and peripherals
- Mobile phones - battery and port protection
- Disk drives
- PDAs / digital cameras
- Game console port protection

Agency Approvals

AGENCY	AGENCY FILE NUMBER
	E183209
	R50119118

Electrical Characteristics

Part Number	Marking	I _{hold} (A)	I _{trip} (A)	V _{max} (Vdc)	I _{max} (A)	P _{d max.} (W)	Maximum Time To Trip		Resistance			Agency Approvals	
							Current (A)	Time (Sec.)	R _{min} (Ω)	R _{typ} (Ω)	R _{1max} (Ω)		
0805L010	A	0.10	0.30	15	100	0.5	0.50	1.50	1.000	3.500	6.000	X	X
0805L020	C	0.20	0.50	9	100	0.5	8.00	0.02	0.650	2.000	3.500	X	X
0805L035	E	0.35	0.75	6	100	0.5	8.00	0.10	0.250	0.750	1.200	X	X
0805L050	F	0.50	1.00	6	100	0.5	8.00	0.10	0.150	0.500	0.850	X	X
0805L075	G	0.75	1.50	6	40	0.6	8.00	0.20	0.090	–	0.350	X	X
0805L100	N	1.0	1.95	6	40	0.6	8.00	0.30	0.060	–	0.210	X	X

I_{hold} = Hold current: maximum current device will pass without tripping in 20°C still air.

I_{trip} = Trip current: minimum current at which the device will trip in 20°C still air.

V_{max} = Maximum voltage device can withstand without damage at rated current (I_{max})

I_{max} = Maximum fault current device can withstand without damage at rated voltage (V_{max})

P_d = Power dissipated from device when in the tripped state at 20°C still air.

R_{min} = Minimum resistance of device in initial (un-soldered) state.

R_{typ} = Typical resistance of device in initial (un-soldered) state.

R_{1max} = Maximum resistance of device at 20°C measured one hour after tripping or reflow soldering of 260°C for 20 sec.

Caution: Operation beyond the specified rating may result in damage and possible arcing and flame.

Temperature Derating

Part Number	Ambient Operation Temperature								
	-40°C	-20°C	0°C	23°C	40°C	50°C	60°C	70°C	85°C
0805L010	0.14	0.12	0.11	0.10	0.08	0.07	0.06	0.05	0.03
0805L020	0.28	0.25	0.23	0.20	0.17	0.14	0.12	0.10	0.07
0805L035	0.47	0.44	0.39	0.35	0.30	0.27	0.24	0.20	0.14
0805L050	0.68	0.62	0.55	0.50	0.40	0.37	0.33	0.29	0.23
0805L075	1.00	0.90	0.79	0.75	0.63	0.57	0.53	0.41	0.34
0805L100	1.35	1.25	1.10	1.00	0.82	0.74	0.65	0.55	0.42

Average Time Current Curves

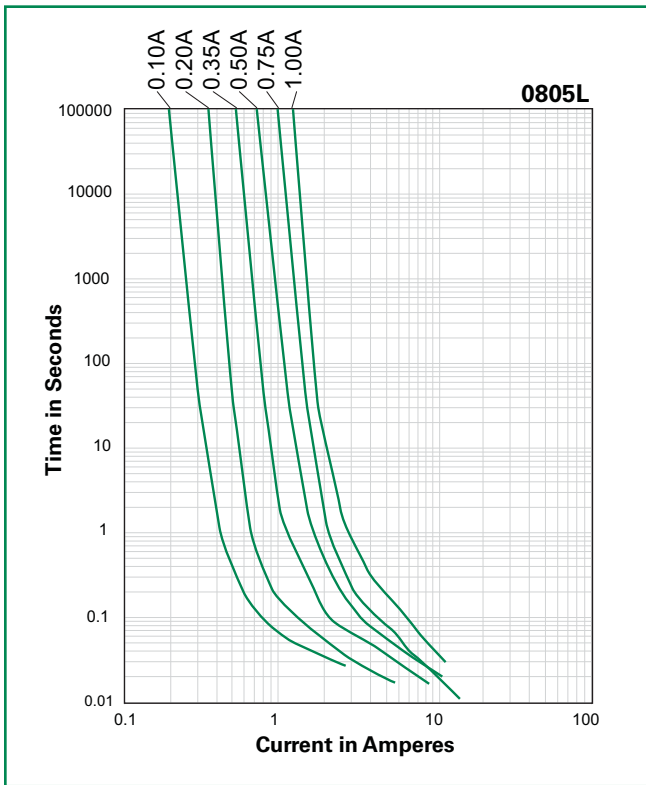

Temperature Derating Curve

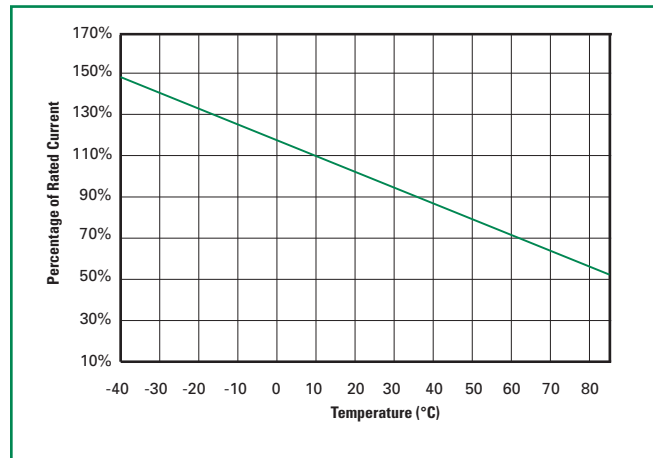

The average time current curves and Temperature Derating curve performance is affected by a number of variables, and these curves provided as guidance only. Customer must verify the performance in their application.

Soldering Parameters

Condition	Reflow
Peak Temp/ Duration Time	260°C / 10 Sec
Time above liquids (TAL) 220°C	60 Sec ~ 100 Sec
Preheat 120°C~ 180°C	50 Sec ~ 150 Sec
Storage Condition	0°C~35°C, ≤70%RH

- Recommended reflow methods: IR, vapor phase oven, hot air oven, N₂ environment for lead-free
- Recommended maximum paste thickness is 0.25mm (0.010 inch)
- Devices can be cleaned using standard industry methods and solvents.

Note: If reflow temperatures exceed the recommended profile, devices may not meet the performance requirements.

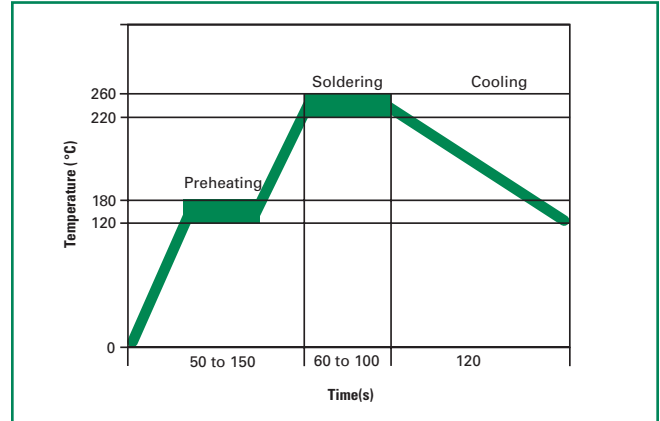

Physical Specifications

Terminal Material	Solder-Plated Copper (Solder Material: Matte Tin (Sn))
Lead Solderability	Meets EIA Specification RS186-9E, ANSI/J-STD-002, Category 3

Environmental Specifications

Operating/Storage Temperature	-40°C to +85°C
Maximum Device Surface Temperature in Tripped State	125°C
Passive Aging	+85°C, 1000 hours -/+5% typical resistance change
Humidity Aging	+85°C, 85%, R.H., 1000 hours -/+5% typical resistance change
Thermal Shock	MIL-STD-202, Method 107G +85°C/-40°C 20 times -30% typical resistance change
Solvent Resistance	MIL-STD-202, Method 215 No change
Vibration	MIL-STD-883C, Method 2007.1, Condition A No change
Moisture Sensitivity Level	Level 2, J-STD-020C

Dimensions

MARKING CODE VARIES WITH AMPERAGE RATING (See Electrical Characteristic Table) SHOWN IS 1.0AMP RATING

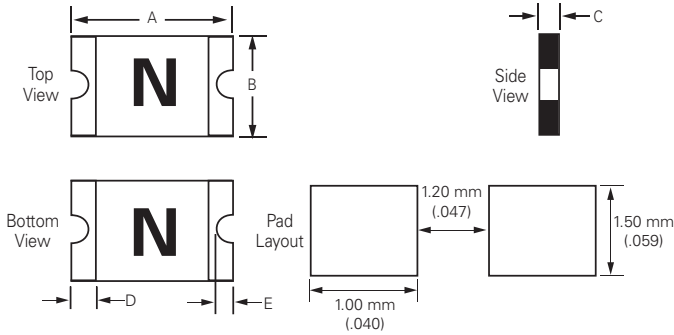

Part Number	A				B				C				D		E			
	Inches		mm		Inches		mm		Inches		mm		Inches	mm	Inches		mm	
	Min.	Max.	Min.	Max.	Min.	Max.	Min.	Max.	Min.	Max.	Min.	Max.	Min.	Min.	Min.	Max.	Min.	Max.
0805L010	0.08	0.09	2.00	2.20	0.05	0.06	1.20	1.50	0.02	0.04	0.55	1.00	0.01	0.20	0.004	0.02	0.10	0.45
0805L020	0.08	0.09	2.00	2.20	0.05	0.06	1.20	1.50	0.02	0.04	0.55	1.00	0.01	0.20	0.004	0.02	0.10	0.45
0805L035	0.08	0.09	2.00	2.20	0.05	0.06	1.20	1.50	0.02	0.03	0.45	0.75	0.01	0.20	0.004	0.02	0.10	0.45
0805L050	0.08	0.09	2.00	2.20	0.05	0.06	1.20	1.50	0.03	0.05	0.75	1.25	0.01	0.20	0.004	0.02	0.10	0.45
0805L075	0.08	0.09	2.00	2.20	0.05	0.06	1.20	1.50	0.03	0.05	0.75	1.25	0.01	0.20	0.006	0.02	0.15	0.45
0805L100	0.08	0.09	2.00	2.20	0.05	0.06	1.20	1.50	0.03	0.07	0.80	1.80	0.01	0.20	0.006	0.02	0.15	0.45

Part Ordering Number System

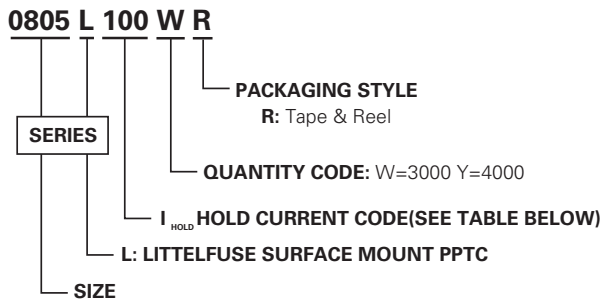

Packaging

Part Number	Ordering Number	I _{hold} (A)	I _{hold} Code	Packaging Option	Quantity	Quantity & Packaging Codes
0805L010	0805L010YR	0.10	010	Tape and Reel	4000	YR
0805L020	0805L020YR	0.20	020	Tape and Reel	4000	YR
0805L035	0805L035YR	0.35	035	Tape and Reel	4000	YR
0805L050	0805L050WR	0.50	050	Tape and Reel	3000	WR
0805L075	0805L075WR	0.75	075	Tape and Reel	3000	WR
0805L100	0805L100WR	1.00	100	Tape and Reel	3000	WR

Tape and Reel Specifications

TAPE SPECIFICATIONS: EIA-481-1 (mm)				
	0805L010 0805L020 0805L035	0805L050	0805L075	0805L100
W	8.0+/-0.10	8.0+/-0.10	8.0+/-0.10	8.0+/-0.10
F	3.5+/-0.05	3.5+/-0.05	3.5+/-0.05	3.5+/-0.05
E₁	1.75+/-0.10	1.75+/-0.10	1.75+/-0.10	1.75+/-0.10
D₀	1.55+/-0.05	1.55+/-0.05	1.55+/-0.05	1.55+/-0.05
D₁	1.0 (min)	1.0 (min)	1.0 (min)	1.0 (min)
P₀	4.0+/-0.10	4.0+/-0.10	4.0+/-0.10	4.0+/-0.10
P₁	4.0+/-0.10	4.0+/-0.10	4.0+/-0.10	4.0+/-0.10
P₂	2.0+/-0.05	2.0+/-0.05	2.0+/-0.05	2.0+/-0.05
A₀	1.45+/-0.10	1.42+/-0.10	1.65+/-0.10	1.65+/-0.10
B₀	2.30+/-0.10	2.24+/-0.10	2.35+/-0.10	2.35+/-0.10
T	0.25+/-0.10	0.20+/-0.10	0.20+/-0.10	0.25+/-0.10
K₀	0.74+/-0.10	1.04+/-0.10	1.05+/-0.10	1.50+/-0.10
Leader min.	390	390	390	390
Trailer min.	160	160	160	160

REEL DIMENSIONS: EIA-481-1 (mm)	
H	12.0+/-0.05
W	9.0+/-0.5
D	Ø60+0.5
F	Ø13.0+/-0.2
C	Ø178+/-1.0
H₁	11+/-0.5
W₁	2.2+/-0.5
W₂	3.0+0.5
W₃	4.0+0.5
W₄	5.5+0.5

0805L Series

Tape and Reel Diagram

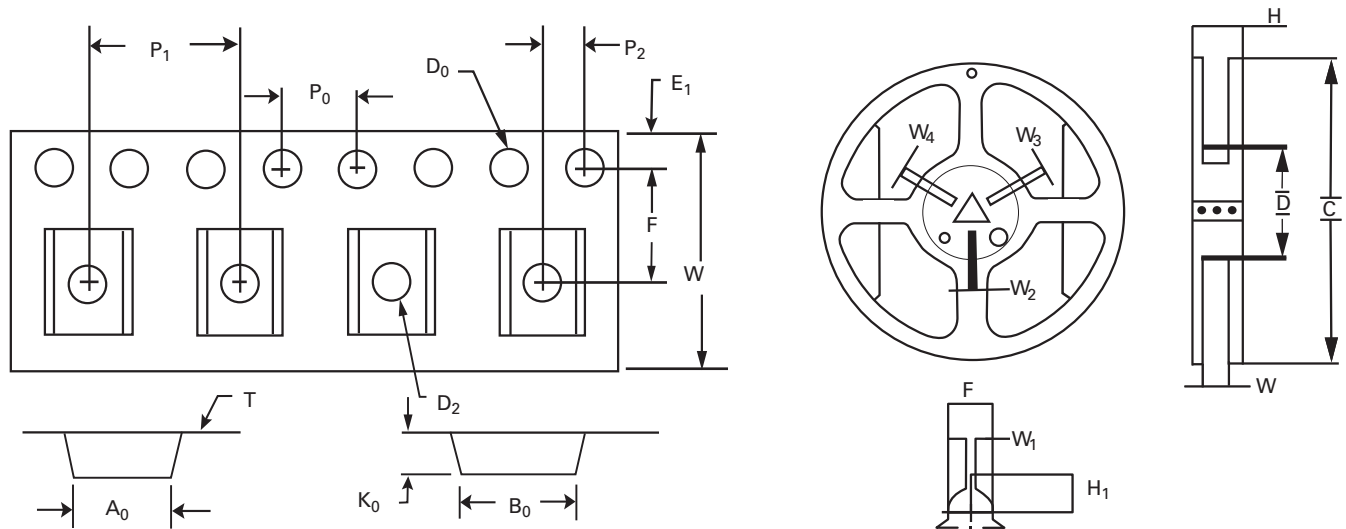



Description

The 1206L Series device provides surface mount overcurrent protection for applications where space is at a premium and resettable protection is desired.



Features

- RoHS compliant and lead-free
- Fast response to fault currents
- Compact design saves board space
- Low resistance
- Low-profile
- Compatible with high temperature solders



Applications

- USB peripherals
- Disk drives
- CD-ROMs
- Plug and play protection for motherboards and peripherals
- Mobile phones - battery and port protection
- Disk drives
- PDAs / digital cameras
- Game console port protection

Agency Approvals

AGENCY	AGENCY FILE NUMBER
	E183209
	R50119118

Electrical Characteristics

Part Number	Marking	I _{hold} (A)	I _{trip} (A)	V _{max} (Vdc)	I _{max} (A)	P _d max. (W)	Maximum Time To Trip		Resistance			Agency Approvals	
							Current (A)	Time (Sec.)	R _{min} (Ω)	R _{typ} (Ω)	R _{1max} (Ω)		
1206L012	A	0.125	0.29	30	100	0.6	1.00	0.20	1.500	3.600	6.000	X	X
1206L016	B	0.16	0.37	30	100	0.6	1.00	0.30	1.200	2.800	4.500	X	X
1206L020-C	C	0.20	0.42	24	100	0.6	8.00	0.10	0.650	1.550	2.600	X	X
1206L025-C	D	0.25	0.50	16	100	0.6	8.00	0.08	0.550	1.400	2.300	X	X
1206L035-C	E	0.35	0.75	6	100	0.6	8.00	0.10	0.300	0.750	1.200	X	X
1206L035/16	J	0.35	0.75	16	100	0.6	8.00	0.10	0.300	0.750	1.200	X	X
1206L050-C	F	0.50	1.00	6	100	0.6	8.00	0.10	0.150	0.400	0.700	X	X
1206L050/15	M	0.50	1.00	15	100	0.6	8.00	0.10	0.150	0.400	0.750	X	X
1206L075-C	G	0.75	1.50	6	100	0.6	8.00	0.20	0.090	0.200	0.290	X	X
1206L100	N	1.00	1.80	6	100	0.8	8.00	0.30	0.055	0.110	0.210	X	X
1206L110-C	H	1.10	2.20	6	100	0.8	8.00	0.30	0.040	0.110	0.180	X	X
1206L150-C	K	1.50	3.00	6	100	0.8	8.00	1.00	0.040	0.080	0.120	X	X

I_{hold} = Hold current: maximum current device will pass without tripping in 20°C still air.

I_{trip} = Trip current: minimum current at which the device will trip in 20°C still air.

V_{max} = Maximum voltage device can withstand without damage at rated current (I_{max})

I_{max} = Maximum fault current device can withstand without damage at rated voltage (V_{max})

P_d = Power dissipated from device when in the tripped state at 20°C still air.

R_{min} = Minimum resistance of device in initial (un-soldered) state.

R_{typ} = Typical resistance of device in initial (un-soldered) state.

R_{1max} = Maximum resistance of device at 20°C measured one hour after tripping or reflow soldering of 260°C for 20 sec.

Caution: Operation beyond the specified rating may result in damage and possible arcing and flame.

Note: Labeling and documentation will vary in displaying **-C** for some items in this product series. There is no difference whether ordered or received with or without the **-C**. See Ordering Number System section of this document for additional information.

Temperature Derating

Part Number	Ambient Operation Temperature								
	-40°C	-20°C	0°C	23°C	40°C	50°C	60°C	70°C	85°C
	Hold Current (A)								
1206L012	0.18	0.16	0.14	0.125	0.10	0.09	0.08	0.07	0.05
1206L016	0.22	0.20	0.18	0.16	0.14	0.12	0.10	0.09	0.08
1206L020-C	0.28	0.25	0.23	0.20	0.17	0.15	0.14	0.12	0.09
1206L025-C	0.37	0.33	0.29	0.25	0.22	0.20	0.17	0.15	0.12
1206L035-C	0.50	0.45	0.40	0.35	0.30	0.27	0.24	0.21	0.15
1206L035/16	0.50	0.45	0.40	0.35	0.30	0.27	0.24	0.21	0.15
1206L050-C	0.71	0.64	0.57	0.50	0.42	0.39	0.35	0.31	0.25
1206L050/15	0.71	0.64	0.57	0.50	0.42	0.39	0.35	0.31	0.25
1206L075-C	1.14	1.01	0.88	0.75	0.65	0.59	0.54	0.49	0.41
1206L100	1.45	1.31	1.15	1.00	0.84	0.77	0.69	0.61	0.48
1206L110-C	1.52	1.37	1.25	1.10	0.92	0.82	0.75	0.64	0.52
1206L150-C	2.18	1.94	1.72	1.50	1.28	1.17	1.06	0.96	0.77

Average Time Current Curves

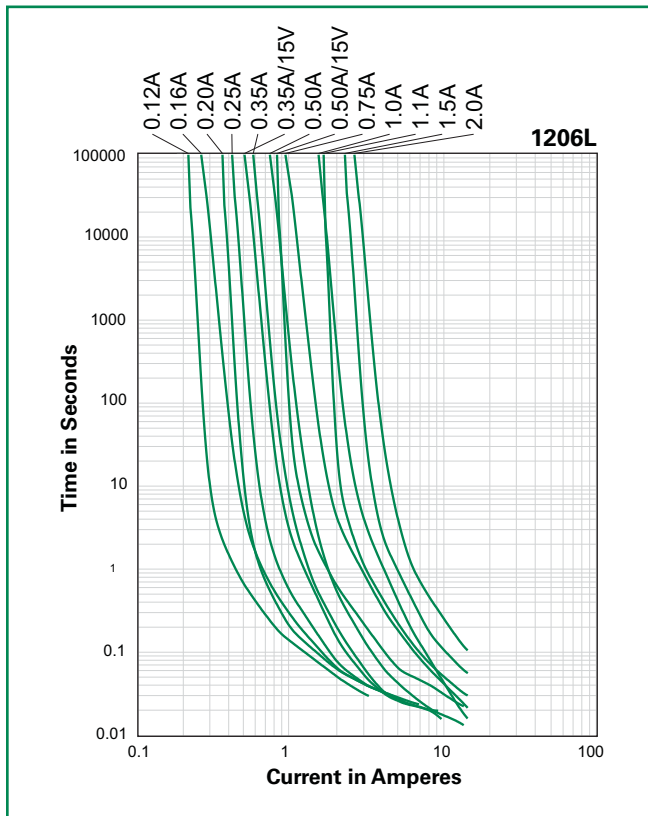

Temperature Derating Curve

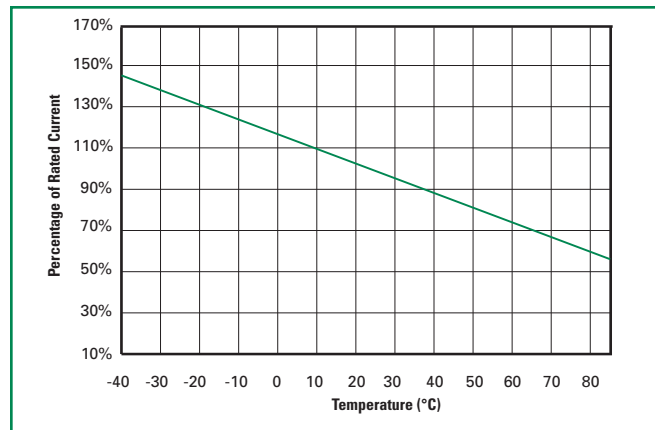

The average time current curves and Temperature Derating curve performance is affected by a number of variables, and these curves provided as guidance only. Customer must verify the performance in their application.

Soldering Parameters

Condition	Reflow
Peak Temp/ DurationTime	260°C / 10 Sec
Time above liquids (TAL) 220°C	60 Sec ~ 100 Sec
Preheat 120°C~ 180°C	50 Sec ~ 150 Sec
Storage Condition	0°C~35°C, 70%RH

- Recommended reflow methods: IR, vapor phase oven, hot air oven, N₂ environment for lead-free
- Recommended maximum paste thickness is 0.25mm (0.010 inch)
- Devices can be cleaned using standard industry methods and solvents.

Note: If reflow temperatures exceed the recommended profile, devices may not meet the performance requirements.

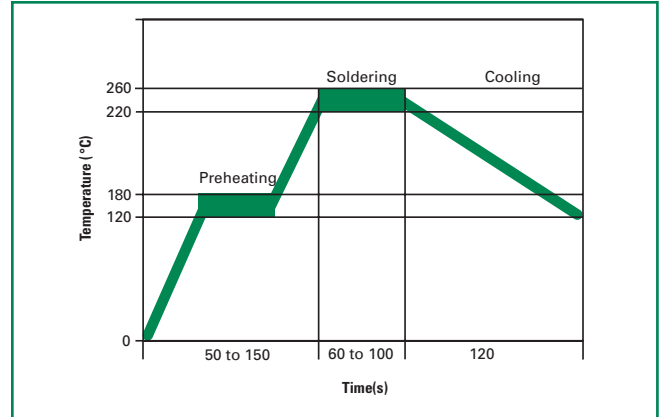

Physical Specifications

Terminal Material	Solder-Plated Copper (Solder Material: Matte Tin (Sn))
Lead Solderability	Meets EIA Specification RS186-9E, ANSI/J-STD-002 Category 3.

Environmental Specifications

Operating/Storage Temperature	-40°C to +85°C
Maximum Device Surface Temperature in Tripped State	125°C
Passive Aging	+85°C, 1000 hours -/ +5% typical resistance change
Humidity Aging	+85°C, 85%, R.H., 1000 hours -/ +5% typical resistance change
Thermal Shock	MIL-STD-202, Method 107G +85°C/-40°C 20 times -30% typical resistance change
Solvent Resistance	MIL-STD-202, Method 215 No change
Vibration	MIL-STD-883C, Method 2007.1, Condition A No change
Moisture Sensivity Level	Level 2, J-STD-020C

Dimensions

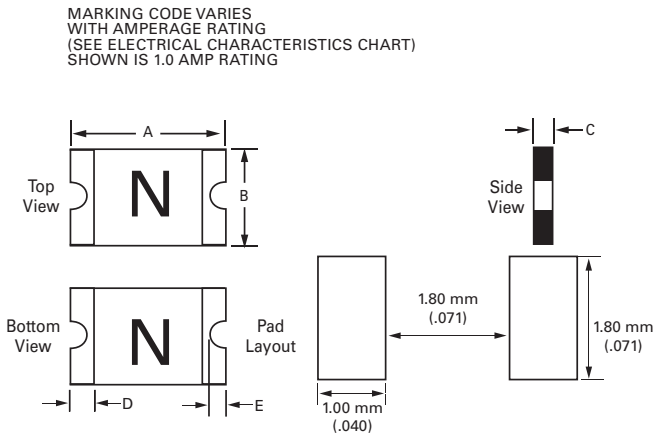

Part Ordering Number System

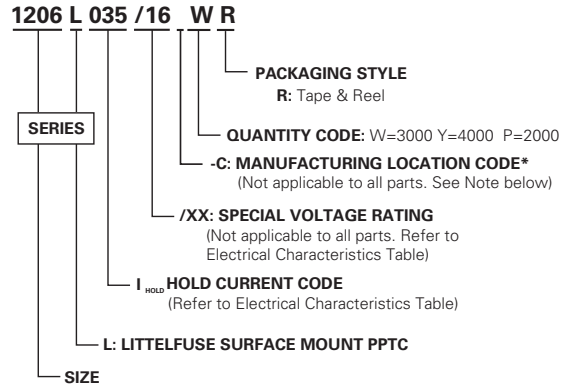

*NOTE: Labeling and documentation will vary in displaying **-C** for some items in this product series. There is no difference whether ordered or received with or without the **-C**.

Part Number	A				B				C				D		E			
	Inches		mm		Inches		mm		Inches		mm		Inches	mm	Inches		mm	
	Min.	Max.	Min.	Max.	Min.	Max.	Min.	Max.	Min.	Max.	Min.	Max.	Min.	Min.	Min.	Max.	Min.	Max.
1206L012	0.12	0.14	3	3.5	0.06	0.07	1.5	1.8	0.03	0.06	0.65	1.45	0.01	0.2	0.004	0.02	0.1	0.45
1206L016	0.12	0.14	3	3.5	0.06	0.07	1.5	1.8	0.03	0.06	0.65	1.45	0.01	0.2	0.004	0.02	0.1	0.45
1206L020-C	0.12	0.14	3	3.5	0.06	0.07	1.5	1.8	0.02	0.04	0.5	1	0.01	0.2	0.004	0.02	0.1	0.45
1206L025-C	0.12	0.14	3	3.5	0.06	0.07	1.5	1.8	0.02	0.04	0.5	1	0.01	0.2	0.004	0.02	0.1	0.45
1206L035-C	0.12	0.14	3	3.5	0.06	0.07	1.5	1.8	0.02	0.03	0.45	0.75	0.01	0.2	0.004	0.02	0.1	0.45
1206L035/16	0.12	0.14	3	3.5	0.06	0.07	1.5	1.8	0.02	0.03	0.45	0.75	0.01	0.2	0.004	0.02	0.1	0.45
1206L050-C	0.12	0.14	3	3.5	0.06	0.07	1.5	1.8	0.02	0.03	0.45	0.75	0.01	0.2	0.004	0.02	0.1	0.45
1206L050/15	0.12	0.14	3	3.5	0.06	0.07	1.5	1.8	0.02	0.03	0.45	0.75	0.01	0.2	0.004	0.02	0.1	0.45
1206L075-C	0.12	0.14	3	3.5	0.06	0.07	1.5	1.8	0.02	0.05	0.45	1.25	0.01	0.2	0.004	0.02	0.1	0.45
1206L100	0.12	0.13	3	3.4	0.06	0.07	1.5	1.8	0.03	0.04	0.75	1	0.01	0.2	0.004	0.02	0.1	0.45
1206L110-C	0.12	0.13	3	3.4	0.06	0.07	1.5	1.8	0.03	0.04	0.75	1	0.01	0.2	0.004	0.02	0.1	0.45
1206L150-C	0.12	0.13	3	3.4	0.06	0.07	1.5	1.8	0.03	0.06	0.85	1.4	0.01	0.2	0.004	0.02	0.1	0.45

Packaging

Part Number	Ordering Number	I _{hold} (A)	I _{hold} Code	Packaging Option	Quantity	Quantity & Packaging Codes
1206L012	1206L012WR	0.125	012	Tape and Reel	3000	WR
1206L016	1206L016WR	0.16	016	Tape and Reel	3000	WR
1206L020-C	1206L020YR	0.20	020	Tape and Reel	4000	YR
1206L025-C	1206L025YR	0.25	025	Tape and Reel	4000	YR
1206L035-C	1206L035YR	0.35	035	Tape and Reel	4000	YR
1206L035/16	1206L035/16YR	0.35	035	Tape and Reel	4000	YR
1206L050-C	1206L050YR	0.50	050	Tape and Reel	4000	YR
1206L050/15	1206L050/15YR	0.50	050	Tape and Reel	4000	YR
1206L075-C	1206L075WR	0.75	075	Tape and Reel	3000	WR
1206L100	1206L100WR	1.00	100	Tape and Reel	3000	WR
1206L110-C	1206L110WR	1.10	110	Tape and Reel	3000	WR
1206L150-C	1206L150PR	1.50	150	Tape and Reel	2000	PR

Tape and Reel Specifications

TAPE SPECIFICATIONS: EIA-481-1 (mm)			
	1206L020-C, 1206L025-C, 1206L035-C, 1206L035/16, 1206L050-C, 1206L050/15, 1206L075	1206L012, 1206L016, 1206L100, 1206L110-C	1206L150-C
W	8.15+0.15-0.30	8.00+/-0.30	8.15+0.15-0.30
F	3.50+/-0.05	3.50+/-0.05	3.50+/-0.05
E₁	1.75+/-0.10	1.75+/-0.10	1.75+/-0.10
D₀	1.55+/-0.05	1.55+/-0.05	1.55+/-0.05
D₁	1.00 (MIN)	1.00 (MIN)	1.00 (MIN)
P₀	4.00+/-0.10	4.00+/-0.10	4.00+/-0.10
P₁	4.00+/-0.10	4.00+/-0.10	4.00+/-0.10
P₂	2.00+/-0.05	2.00+/-0.05	2.00+/-0.05
A₀	1.95+/-0.10	1.95+/-0.10	1.95+/-0.10
B₀	3.65+/-0.10	3.65+/-0.10	3.65+/-0.10
T	0.25+/-0.10	0.25+/-0.10	0.25+/-0.10
K₀	0.87+/-0.10	1.30+/-0.10	1.70+/-0.10
<i>Leader min.</i>	390	390	390
<i>Trailer min.</i>	160	160	160

REEL DIMENSIONS: EIA-481-1 (mm)	
H	16.0+/-0.2
W	13.2+/-1.5
D	Ø 60.2+/-0.5
F	Ø 13.0+/-0.5
C	Ø 178+/-1.0
H₁	11+/-0.5
W₁	2.5+0.5
W₂	3.0+0.5
W₃	4.0+0.5
W₄	5.0+0.5

1206L Series

Tape and Reel Diagram

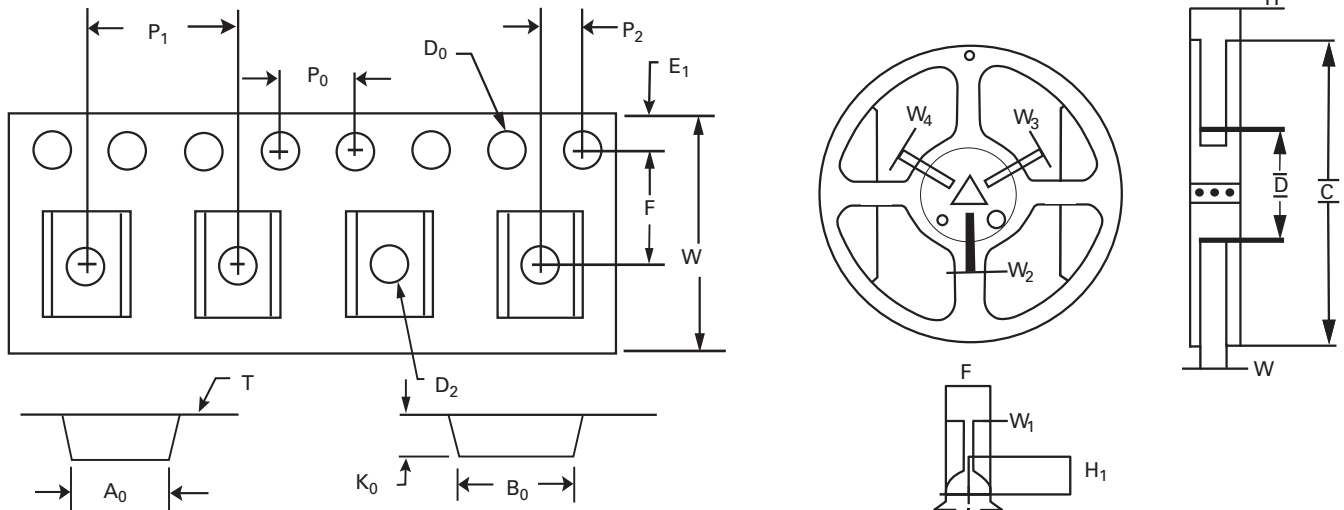



Description

The 1210L Series device provides surface mount overcurrent protection for applications where space is at a premium and resettable protection is desired.



Features

- RoHS compliant and lead-free
- Fast response to fault currents
- Compact design saves board space
- Low resistance
- Low-profile
- Compatible with high temperature solders



Applications

- USB peripherals
- Disk drives
- CD-ROMs
- PC motherboards - plug and play protection
- Mobile phones - battery and port protection
- PDAs / digital cameras
- Game console port protection

Agency Approvals

AGENCY	AGENCY FILE NUMBER
	E183209
	R50119118

Electrical Characteristics

Part Number	Marking	I _{hold} (A)	I _{trip} (A)	V _{max} (Vdc)	I _{max} (A)	P _d max. (W)	Maximum Time To Trip		Resistance			Agency Approvals	
							Current (A)	Time (Sec.)	R _{min} (Ω)	R _{typ} (Ω)	R _{1max} (Ω)		
1210L005	A	0.05	0.15	30	10	0.60	0.25	1.50	3.600	25.00	50.00	X	X
1210L010	B	0.10	0.30	30	10	0.60	0.50	1.50	1.600	7.000	15.00	X	X
1210L020	C	0.20	0.40	30	10	0.60	8.00	0.02	0.800	2.900	5.000	X	X
1210L035	E	0.35	0.70	6	100	0.60	8.00	0.20	0.320	0.810	1.300	X	X
1210L050	F	0.50	1.00	13.2	100	0.60	8.00	0.10	0.250	0.550	0.900	X	X
1210L075	G	0.75	1.50	6	100	0.60	8.00	0.10	0.130	0.290	0.400	X	X
1210L110	H	1.10	2.20	6	100	0.60	8.00	0.30	0.060	0.140	0.210	X	X
1210L150	K	1.50	3.00	6	100	0.80	8.00	0.50	0.040	0.070	0.110	X	X

I_{hold} = Hold current: maximum current device will pass without tripping in 20°C still air.
 I_{trip} = Trip current: minimum current at which the device will trip in 20°C still air.
 V_{max} = Maximum voltage device can withstand without damage at rated current (I_{max})
 I_{max} = Maximum fault current device can withstand without damage at rated voltage (V_{max})
 P_d = Power dissipated from device when in the tripped state at 20°C still air.
 R_{min} = Minimum resistance of device in initial (un-soldered) state.

R_{typ} = Typical resistance of device in initial (un-soldered) state.
 R_{1max} = Maximum resistance of device at 20°C measured one hour after tripping or reflow soldering of 260°C for 20 sec.

Caution: Operation beyond the specified rating may result in damage and possible arcing and flame.

Temperature Derating

Part Number	Ambient Operation Temperature								
	-40°C	-20°C	0°C	23°C	40°C	50°C	60°C	70°C	85°C
1210L005	0.08	0.07	0.06	0.05	0.04	0.04	0.03	0.03	0.02
1210L010	0.16	0.14	0.12	0.10	0.08	0.07	0.06	0.05	0.03
1210L020	0.29	0.26	0.22	0.20	0.16	0.14	0.13	0.11	0.08
1210L035	0.47	0.45	0.40	0.35	0.33	0.28	0.24	0.21	0.18
1210L050	0.76	0.67	0.58	0.50	0.43	0.40	0.36	0.32	0.28
1210L075	1.00	0.97	0.86	0.75	0.64	0.59	0.54	0.48	0.40
1210L110	1.69	1.48	1.29	1.10	0.88	0.76	0.65	0.57	0.43
1210L150	2.13	1.92	1.71	1.50	1.26	1.14	1.01	0.89	0.71

Average Time Current Curves

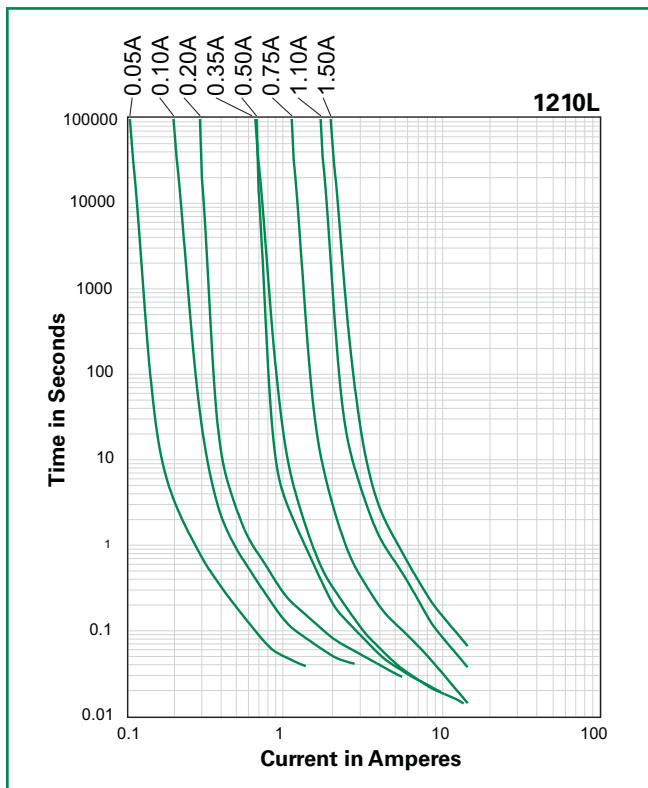

Temperature Derating Curve

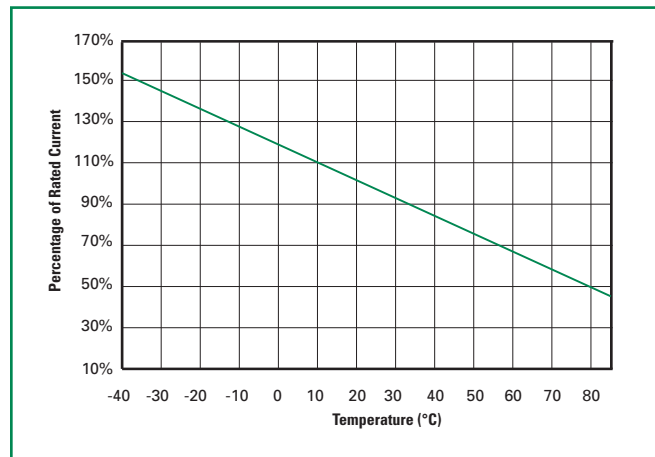

The average time current curves and Temperature Derating curve performance is affected by a number of variables, and these curves provided as guidance only. Customer must verify the performance in their application.

Soldering Parameters

Condition	Reflow
Peak Temp/ Duration Time	260°C / 10 Sec
Time above liquids (TAL) 220°C	60 Sec ~ 100 Sec
Preheat 120°C~ 180°C	50 Sec ~ 150 Sec
Storage Condition	0°C~35°C, ≤70%RH

- Recommended reflow methods: IR, vapor phase oven, hot air oven, N₂ environment for lead-free
- Recommended maximum paste thickness is 0.25mm (0.010 inch)
- Devices can be cleaned using standard industry methods and solvents.

Note: If reflow temperatures exceed the recommended profile, devices may not meet the performance requirements.

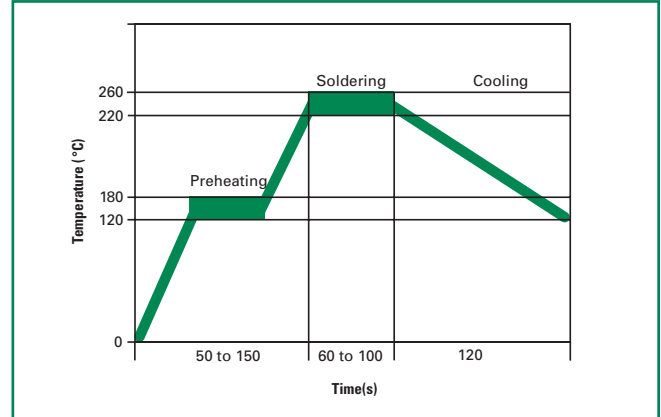

Physical Specifications

Terminal Material	Solder-Plated Copper (Solder Material: Matte Tin (Sn))
Lead Solderability	Meets EIA Specification RS186-9E, ANSI/J-STD-002 Category 3.

Environmental Specifications

Operating/Storage Temperature	-40°C to +85°C
Maximum Device Surface Temperature in Tripped State	125°C
Passive Aging	+85°C, 1000 hours -/+5% typical resistance change
Humidity Aging	+85°C, 85, R.H., 1000 hours -/+5% typical resistance change
Thermal Shock	MIL-STD-202, Method 107G +85°C/-40°C, 20 times -30% typical resistance change
Solvent Resistance	MIL-STD-202, Method 215 No change
Vibration	MIL-STD-883C, Method 2007.1, Condition A No change
Moisture Level Sensitivity	Level 2, J-STD-020C

Dimensions

MARKING CODE VARIES WITH AMPERAGE RATING (See Electrical Characteristics Table) SHOWN IS 1.5AMP RATING

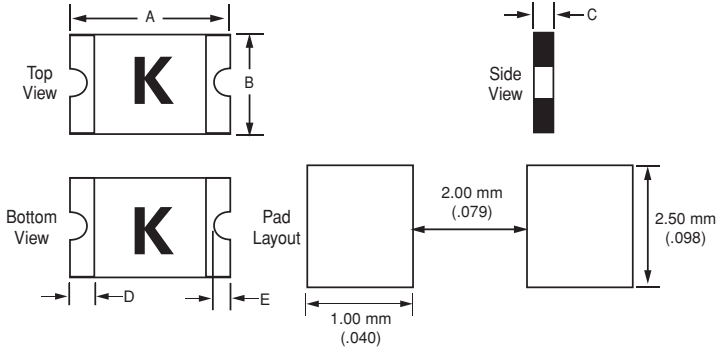

Part Number	A				B				C				D		E			
	Inches		mm		Inches		mm		Inches		mm		Inches	mm	Inches		mm	
	Min.	Max.	Min.	Max.	Min.	Max.	Min.	Max.	Min.	Max.	Min.	Max.	Min.	Min.	Min.	Max.	Min.	Max.
1210L005	0.12	0.14	3.00	3.43	0.09	0.11	2.35	2.80	0.03	0.05	0.75	1.25	0.01	0.25	0.008	0.02	0.20	0.50
1210L010	0.12	0.14	3.00	3.43	0.09	0.11	2.35	2.80	0.03	0.05	0.75	1.25	0.01	0.25	0.008	0.02	0.20	0.50
1210L020	0.12	0.14	3.00	3.43	0.09	0.11	2.35	2.80	0.02	0.04	0.60	1.00	0.01	0.25	0.008	0.02	0.20	0.50
1210L035	0.12	0.14	3.00	3.43	0.09	0.11	2.35	2.80	0.02	0.03	0.50	0.85	0.01	0.25	0.008	0.02	0.20	0.50
1210L050	0.12	0.14	3.00	3.43	0.09	0.11	2.35	2.80	0.02	0.03	0.50	0.85	0.01	0.25	0.008	0.02	0.20	0.50
1210L075	0.12	0.14	3.00	3.43	0.09	0.11	2.35	2.80	0.02	0.03	0.50	0.85	0.01	0.25	0.008	0.02	0.20	0.50
1210L110	0.12	0.14	3.00	3.43	0.09	0.11	2.35	2.80	0.04	0.05	0.90	1.30	0.01	0.25	0.008	0.02	0.20	0.50
1210L150	0.12	0.14	3.00	3.43	0.09	0.11	2.35	2.80	0.03	0.07	0.80	1.80	0.01	0.25	0.008	0.02	0.20	0.50

Part Ordering Number System

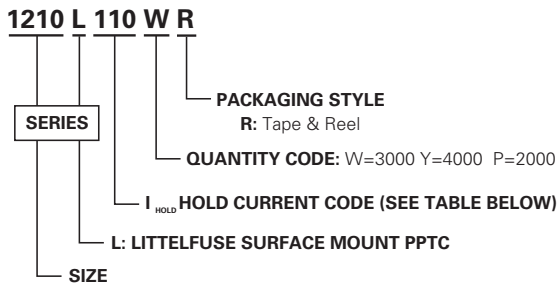

Packaging

Part Number	Ordering Number	I _{hold} (A)	I _{hold} Code	Packaging Option	Quantity	Quantity & Packaging Codes
1210L005	1210L005WR	0.05	005	Tape and Reel	3000	WR
1210L010	1210L010WR	0.10	010	Tape and Reel	3000	WR
1210L020	1210L020WR	0.20	020	Tape and Reel	3000	WR
1210L035	1210L035YR	0.35	035	Tape and Reel	4000	YR
1210L050	1210L050YR	0.50	050	Tape and Reel	4000	YR
1210L075	1210L075YR	0.75	075	Tape and Reel	4000	YR
1210L110	1210L110WR	1.10	110	Tape and Reel	3000	WR
1210L150	1210L150PR	1.50	150	Tape and Reel	2000	PR

Tape and Reel Specifications

TAPE SPECIFICATIONS: EIA-481-1 (mm)			
	1210L035, 1210L050, 1210L075	1210L005, 1210L010, 1210L020, 1210L110	1210L150
W	8.0+/-0.30	8.0+/-0.30	8.0+/-0.30
F	3.5+/-0.05	3.5+/-0.05	3.5+/-0.05
E₁	1.75+/-0.10	1.75+/-0.10	1.75+/-0.10
D₀	1.55+/-0.05	1.55+/-0.05	1.55+/-0.05
D₁	1.0 (min)	1.0 (min)	1.0 (min)
P₀	4.0+/-0.10	4.0+/-0.10	4.0+/-0.10
P₁	4.0+/-0.10	4.0+/-0.10	4.0+/-0.10
P₂	2.0+/-0.05	2.0+/-0.05	2.0+/-0.05
A₀	2.82+/-0.10	2.82+/-0.10	2.67+/-0.10
B₀	3.46+/-0.10	3.46+/-0.10	3.36+/-0.10
T	0.25+/-0.10	0.25+/-0.10	0.25+/-0.10
K₀	1.00+/-0.10	1.30+/-0.10	1.65+/-0.10
Leader min.	390	390	390
Trailer min.	160	160	160

REEL DIMENSIONS: EIA-481-1 (mm)	
H	12.0+/-0.05
W	9.0+/-0.5
D	Ø 60+0.5
F	Ø 13.0+/-0.2
C	Ø 178+/-1.0
H₁	11+/-0.5
W₁	2.2+/-0.5
W₂	3.0+0.5
W₃	4.0+0.5
W₄	5.5+0.5

1210L Series

Tape and Reel Diagram

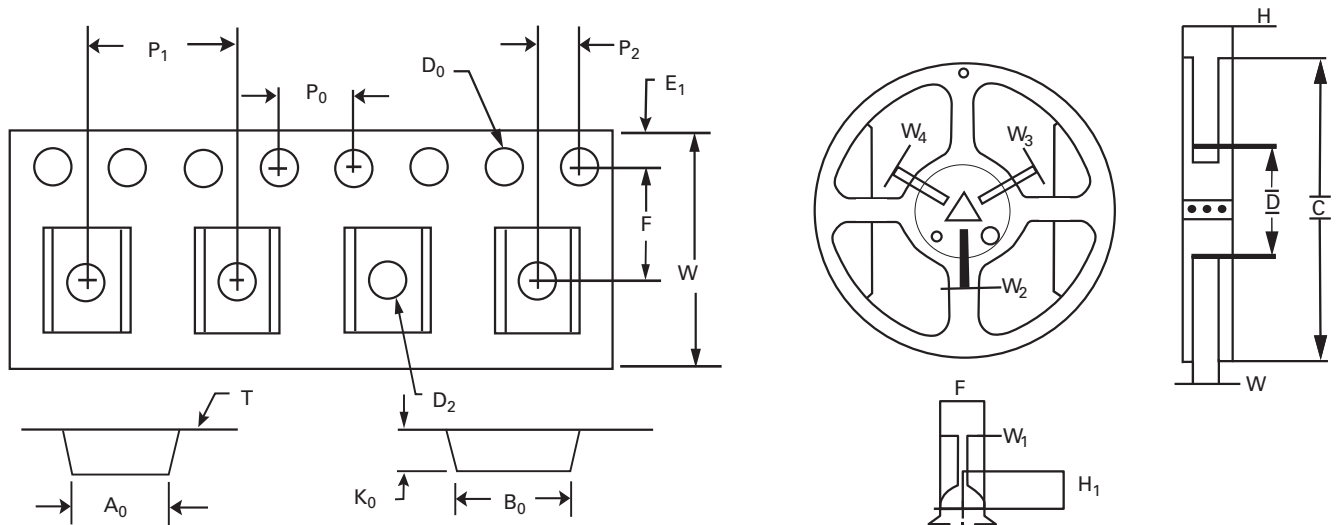

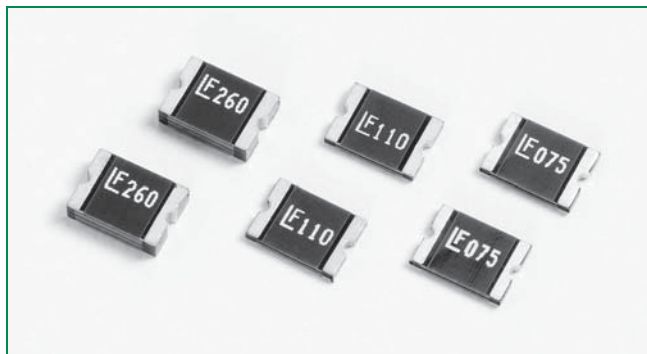

Agency Approvals

AGENCY AGENCY FILE NUMBER



E183209



R50119118

Description

The 1812L Series device provides surface mount overcurrent protection for applications where resettable protection is desired.



Features

- RoHS compliant and lead-free
- Fast response to fault currents
- Compact design saves board space
- Low resistance
- Low-profile
- Compatible with high temperature solders

Applications

- Plug and play protection for motherboards and peripherals
- USB peripherals
- PCI cards
- Game console port protection

Electrical Characteristics

Part Number	Marking	I _{hold} (A)	I _{trip} (A)	V _{max} (Vdc)	I _{max} (A)	P _d max. (W)	Maximum Time To Trip		Resistance			Agency Approvals	
							Current (A)	Time (Sec.)	R _{min} (Ω)	R _{typ} (Ω)	R _{1max} (Ω)		
1812L010	LF010	0.10	0.30	30	100	0.8	0.50	1.50	1.600	7.000	15.000	X	X
1812L014	LF014	0.14	0.34	60	10	0.8	1.50	0.15	1.500	4.000	6.000	X	X
1812L020	LF020	0.20	0.40	30	100	0.8	8.00	0.02	0.800	2.900	5.000	X	X
1812L050-C	LF050	0.50	1.00	15	100	0.8	8.00	0.15	0.150	0.600	1.000	X	X
1812L075-C	LF075	0.75	1.50	13.2	100	0.8	8.00	0.20	0.100	0.260	0.450	X	X
1812L075/24	LF075-24	0.75	1.50	24	100	0.8	8.00	0.20	0.110	0.200	0.290	X	X
1812L075/33	LF075-33	0.75	1.50	33	20	0.8	8.00	0.20	0.110	0.260	0.400	X	X
1812L110-C	LF110	1.10	2.20	6	100	0.8	8.00	0.30	0.040	0.120	0.210	X	X
1812L110/16	LF110-16	1.10	1.95	16	100	0.8	8.00	0.50	0.060	0.120	0.180	X	X
1812L110/33	LF110-33	1.10	1.95	33	20	0.8	8.00	0.50	0.060	0.120	0.200	X	X
1812L125-C	LF125	1.25	2.50	15	100	0.8	8.00	0.40	0.050	0.160	0.250	X	X
1812L125/6	LF125-6	1.25	2.50	6	100	0.8	8.00	0.40	0.050	0.090	0.140	X	X
1812L150-C	LF150	1.50	3.00	8	100	0.8	8.00	0.30	0.040	0.070	0.110	X	X
1812L150/12	LF150-12	1.50	3.00	12	100	0.8	8.00	0.50	0.040	0.070	0.110	X	X
1812L150/24	LF150-24	1.50	3.00	24	20	0.8	8.00	1.50	0.040	0.070	0.120	X	X
1812L160-C	LF160	1.60	2.80	8	100	0.8	8.00	1.00	0.030	0.066	0.100	X	X
1812L160/12	LF160-12	1.60	2.80	12	100	0.8	8.00	1.00	0.030	0.066	0.100	X	X
1812L200-C	LF200	2.00	3.50	8	100	0.8	8.00	2.00	0.020	0.040	0.060	X	X
1812L260-C	LF260	2.60	5.00	6	100	0.8	8.00	2.50	0.015	0.030	0.047	X	X

I_{hold} = Hold current: maximum current device will pass without tripping in 20°C still air.

I_{trip} = Trip current: minimum current at which the device will trip in 20°C still air.

V_{max} = Maximum voltage device can withstand without damage at rated current (I_{max})

I_{max} = Maximum fault current device can withstand without damage at rated voltage (V_{max})

Caution: Operation beyond the specified rating may result in damage and possible arcing and flame.

Note: Labeling and documentation will vary in displaying -C for some items in this product series. There is no difference whether ordered or received with or without the -C. See Ordering Number System section of this document for additional information.

P_d = Power dissipated from device when in the tripped state at 20°C still air.

R_{min} = Minimum resistance of device in initial (un-soldered) state.

R_{typ} = Typical resistance of device in initial (un-soldered) state.

R_{1max} = Maximum resistance of device at 20°C measured one hour after tripping or reflow soldering of 260°C for 20 sec.

Temperature Derating

Part Number	Ambient Operation Temperature								
	-40°C	-20°C	0°C	23°C	40°C	50°C	60°C	70°C	85°C
	Hold Current (A)								
1812L010	0.16	0.14	0.12	0.10	0.08	0.07	0.06	0.05	0.03
1812L014	0.23	0.19	0.17	0.14	0.12	0.10	0.09	0.08	0.06
1812L020	0.29	0.26	0.23	0.20	0.17	0.15	0.14	0.12	0.10
1812L050-C	0.77	0.68	0.59	0.50	0.44	0.40	0.37	0.33	0.29
1812L075-C	1.15	1.01	0.88	0.75	0.65	0.60	0.55	0.49	0.43
1812L075/24	1.06	0.95	0.84	0.75	0.60	0.55	0.50	0.45	0.37
1812L075/33	1.10	1.00	0.88	0.75	0.66	0.60	0.56	0.47	0.36
1812L110-C	1.59	1.43	1.26	1.10	0.95	0.87	0.80	0.71	0.60
1812L110/16	1.58	1.43	1.27	1.10	0.95	0.85	0.77	0.71	0.58
1812L110/33	1.55	1.40	1.25	1.10	0.93	0.83	0.73	0.63	0.50
1812L125-C	2.00	1.75	1.52	1.25	1.00	0.95	0.90	0.75	0.53
1812L125/6	2.00	1.75	1.52	1.25	1.00	0.95	0.90	0.75	0.53
1812L150-C	2.06	1.93	1.79	1.50	1.28	1.10	1.02	0.80	0.68
1812L150/12	2.04	1.88	1.68	1.50	1.25	1.10	1.00	0.80	0.60
1812L150/24	2.05	1.87	1.67	1.50	1.25	1.08	0.95	0.77	0.60
1812L160-C	2.20	2.06	1.91	1.60	1.36	1.17	1.09	0.85	0.72
1812L160/12	2.18	2.01	1.79	1.60	1.34	1.16	1.07	0.83	0.60
1812L200-C	3.08	2.71	2.35	2.00	1.80	1.60	1.50	1.07	0.80
1812L260-C	4.00	3.52	3.06	2.60	2.34	2.08	1.95	1.39	1.04

Average Time Current Curves

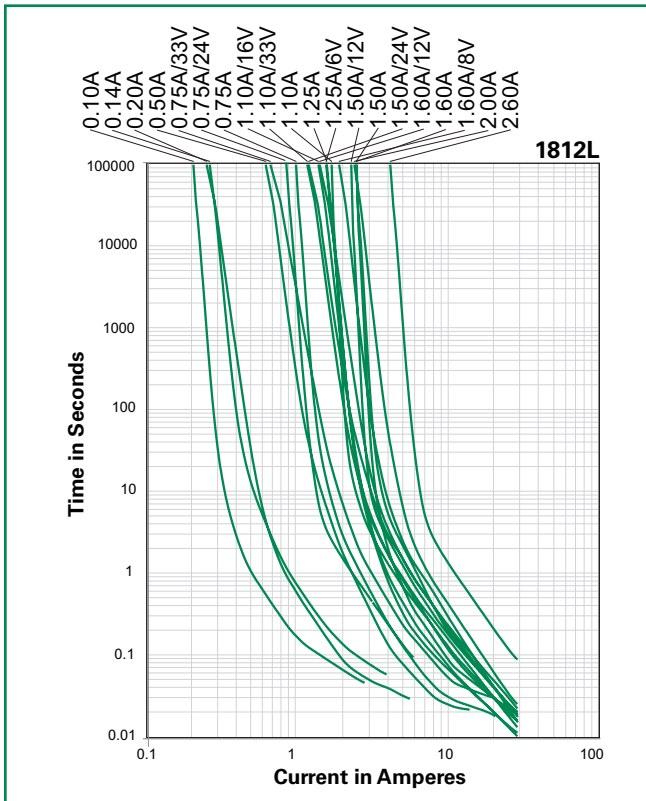

Temperature Derating Curve

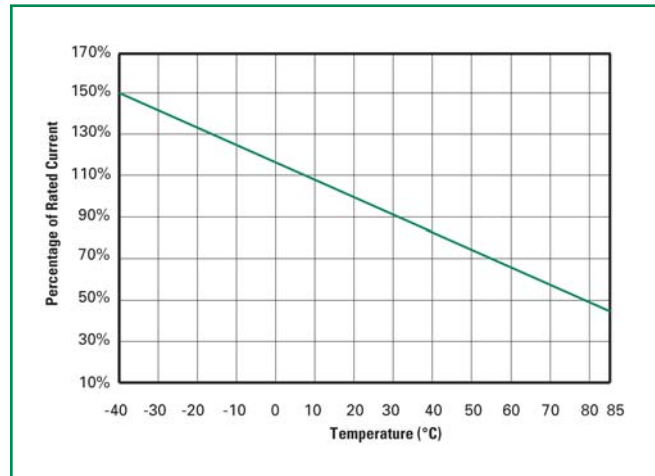

The average time current curves and Temperature Derating curve performance is affected by a number of variables, and these curves provided as guidance only. Customer must verify the performance in their application.

Soldering Parameters

Condition	Reflow
Peak Temp/ DurationTime	260°C / 10 Sec
Time above liquids (TAL) 220°C	60 Sec ~ 100 Sec
Preheat 120°C~ 180°C	50 Sec ~ 150 Sec
Storage Condition	0°C~35°C, ≤70%RH

- Recommended reflow methods: IR, vapor phase oven, hot air oven, N₂ environment for lead-free
- Recommended maximum paste thickness is 0.25mm (0.010 inch)
- Devices can be cleaned using standard industry methods and solvents.

Note: If reflow temperatures exceed the recommended profile, devices may not meet the performance requirements.

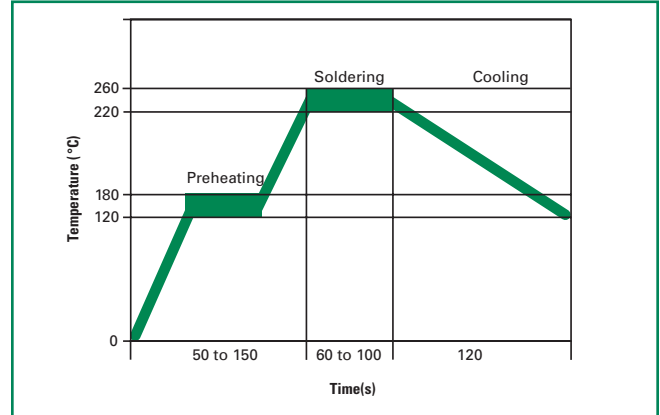

Physical Specifications

Terminal Material	Solder-Plated Copper (Solder Material: Matte Tin (Sn))
Lead Solderability	Meets EIA Specification RS186-9E, ANSI/J-STD-002 Category 3.

Environmental Specifications

Operating/Storage Temperature	-40°C to +85°C
Maximum Device Surface Temperature in Tripped State	125°C
Passive Aging	+85°C, 1000 hours -/+5% typical resistance change
Humidity Aging	+85°C, 85% R.H., 1000 hours -/+5% typical resistance change
Thermal Shock	MIL-STD-202, Method 107G +85°C/-40°C 20 times -30% typical resistance change
Solvent Resistance	MIL-STD-202, Method 215 No change
Vibration	MIL-STD-883C, Method 2007.1, Condition A No change
Moisture Level Sensitivity	Level 2, J-STD-020C

Dimensions

MARKING CODE VARIES
WITH AMPERAGE AND VOLTAGE RATING
(See Electrical Characteristics Table)
SHOWN ARE:
- 1.1A/6V RATING (LEFT)
- 1.1A/33V RATING (RIGHT)

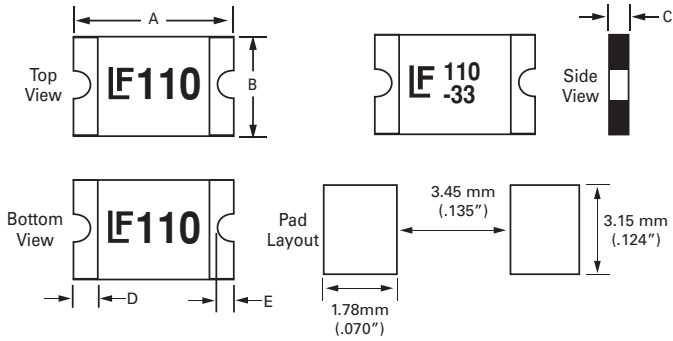

Part Number	A				B				C				D		E			
	Inches		mm		Inches		mm		Inches		mm		Inches	mm	Inches		mm	
	Min.	Max.	Min.	Max.	Min.	Max.	Min.	Max.	Min.	Max.	Min.	Max.	Min.	Max.	Min.	Max.	Min.	Max.
1812L010	0.17	0.19	4.37	4.73	0.12	0.13	3.07	3.41	0.03	0.05	0.75	1.25	0.01	0.30	0.01	0.03	0.25	0.65
1812L014	0.17	0.19	4.37	4.73	0.12	0.13	3.07	3.41	0.03	0.08	0.75	1.95	0.01	0.30	0.01	0.03	0.25	0.65
1812L020	0.17	0.19	4.37	4.73	0.12	0.13	3.07	3.41	0.02	0.04	0.55	1	0.01	0.30	0.01	0.03	0.25	0.65
1812L050-C	0.17	0.19	4.37	4.73	0.12	0.13	3.07	3.41	0.02	0.03	0.5	0.75	0.01	0.30	0.01	0.02	0.25	0.5
1812L075-C	0.17	0.19	4.37	4.73	0.12	0.13	3.07	3.41	0.02	0.03	0.5	0.75	0.01	0.30	0.01	0.02	0.25	0.5
1812L075/24	0.17	0.19	4.37	4.73	0.12	0.13	3.07	3.41	0.03	0.06	0.75	1.55	0.01	0.30	0.01	0.03	0.25	0.65
1812L075/33	0.17	0.19	4.37	4.73	0.12	0.13	3.07	3.41	0.03	0.06	0.75	1.55	0.01	0.30	0.01	0.03	0.25	0.65
1812L110-C	0.17	0.19	4.37	4.73	0.12	0.13	3.07	3.41	0.02	0.03	0.5	0.71	0.01	0.30	0.01	0.02	0.25	0.5
1812L110/16	0.17	0.19	4.37	4.73	0.12	0.13	3.07	3.41	0.03	0.05	0.75	1.25	0.01	0.30	0.01	0.03	0.25	0.65
1812L110/33	0.17	0.19	4.37	4.73	0.12	0.13	3.07	3.41	0.05	0.08	1.2	2	0.01	0.30	0.01	0.03	0.25	0.65
1812L125-C	0.17	0.19	4.37	4.73	0.12	0.13	3.07	3.41	0.03	0.05	0.75	1.25	0.01	0.30	0.01	0.02	0.25	0.5
1812L125/6	0.17	0.19	4.37	4.73	0.12	0.13	3.07	3.41	0.02	0.03	0.45	0.75	0.01	0.30	0.01	0.03	0.25	0.65
1812L150-C	0.17	0.19	4.37	4.73	0.12	0.13	3.07	3.41	0.02	0.03	0.4	0.71	0.01	0.30	0.01	0.03	0.25	0.65
1812L150/12	0.17	0.19	4.37	4.73	0.12	0.13	3.07	3.41	0.03	0.05	0.75	1.25	0.01	0.30	0.01	0.03	0.25	0.65
1812L150/24	0.17	0.19	4.37	4.73	0.12	0.13	3.07	3.41	0.03	0.07	0.8	1.8	0.01	0.30	0.01	0.03	0.25	0.65
1812L160-C	0.17	0.19	4.37	4.73	0.12	0.13	3.07	3.41	0.02	0.03	0.4	0.75	0.01	0.30	0.01	0.03	0.25	0.65
1812L160/12	0.17	0.19	4.37	4.73	0.12	0.13	3.07	3.41	0.03	0.05	0.75	1.25	0.01	0.30	0.01	0.03	0.25	0.65
1812L200-C	0.17	0.19	4.37	4.73	0.12	0.13	3.07	3.41	0.03	0.05	0.81	1.2	0.01	0.30	0.01	0.02	0.25	0.5
1812L260-C	0.17	0.19	4.37	4.73	0.12	0.13	3.07	3.41	0.03	0.05	0.8	1.34	0.01	0.30	0.01	0.02	0.25	0.5

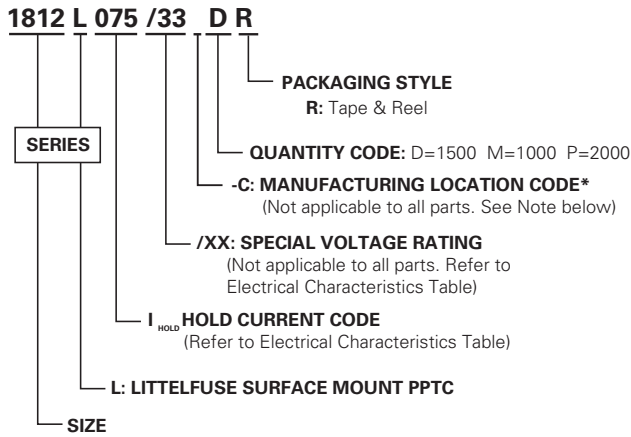
Part Ordering Number System

***NOTE:** Labeling and documentation will vary in displaying **-C** for some items in this product series. There is no difference whether ordered or received with or without the **-C**.

Packaging

Part Number	Ordering Number	I _{hold} (A)	I _{hold} Code	Voltage Option	Packaging Option	Quantity	Quantity & Packaging Codes
1812L010	1812L010DR	0.10	010		Tape and Reel	1500	DR
1812L014	1812L014DR	0.14	014		Tape and Reel	1500	DR
1812L020	1812L020PR	0.20	020		Tape and Reel	2000	PR
1812L050-C	1812L050PR	0.50	050		Tape and Reel	2000	PR
1812L075-C	1812L075PR	0.75	075		Tape and Reel	2000	PR
1812L75/24	1812L75/24DR	0.75	075	/24	Tape and Reel	1500	DR
1812L75/33	1812L75/33DR	0.75	075	/33	Tape and Reel	1500	DR
1812L110-C	1812L110PR	1.10	110		Tape and Reel	2000	PR
1812L110/16	1812L110/16DR	1.10	110	/16	Tape and Reel	1500	DR
1812L110/33	1812L110/33MR	1.10	110	/33	Tape and Reel	1000	MR
1812L125-C	1812L125DR	1.25	125		Tape and Reel	1500	DR
1812L125/6	1812L125/6PR	1.25	125	/6	Tape and Reel	2000	PR
1812L150-C	1812L150ZR	1.50	150		Tape and Reel	2000	ZR
1812L150/12	1812L150/12DR	1.50	150	/12	Tape and Reel	1500	DR
1812L150/24	1812L150/24MR	1.50	150	/24	Tape and Reel	1000	MR
1812L160-C	1812L160PR	1.60	160		Tape and Reel	2000	PR
1812L160/12	1812L160/12DR	1.60	160	/12	Tape and Reel	1500	DR
1812L200-C	1812L200DR	2.00	200		Tape and Reel	1500	DR
1812L260-C	1812L260ZR	2.60	260		Tape and Reel	1000	ZR

Tape and Reel Specifications

TAPE SPECIFICATIONS: EIA-481-1 (mm)			
	1812L020, 1812L050-C, 1812L075-C, 1812L110-C, 1812L125/6, 1812L150-C, 1812L160-C	1812L010, 1812L014, 1812L075/24, 1812L075/33, 1812L110/16, 1812L125-C, 1812L150/12, 1812L160/12, 1812L200-C	1812L110/33, 1812L150/24, 1812L260-C
W	12.00+0.30-0.10	12.00+/-0.30	12.00+/-0.30
F	5.50+/-0.05	5.50+/-0.05	5.50+/-0.05
E₁	1.75+/-0.10	1.75+/-0.10	1.75+/-0.10
D₀	1.50+0.10	1.55+/-0.05	1.55+/-0.05
D₁	1.50+0.25	1.50 (MIN)	1.50 (MIN)
P₀	4.00+/-0.10	4.00+/-0.10	4.00+/-0.10
P₁	8.00+/-0.10	8.00+/-0.10	8.00+/-0.10
P₂	2.00+/-0.05	2.00+/-0.05	2.00+/-0.05
A₀	3.58+/-0.10	3.58+/-0.10	3.58+/-0.10
B₀	4.93+/-0.10	4.93+/-0.10	4.93+/-0.10
T	0.25+/-0.10	0.25+/-0.10	0.25+/-0.10
K₀	1.02+/-0.10	1.30+/-0.10	2.10+/-0.10
<i>Leader min.</i>	390	390	390
<i>Trailer min.</i>	160	160	160

REEL DIMENSIONS: EIA-481-1 (mm)	
H	16.0+/-0.2
W	13.2+/-1.5
D	Ø 60.2+/-0.5
F	Ø13.0+/-0.5
C	Ø178+/-1.0
H₁	11+/-0.5
W₁	2.5+0.5
W₂	3.0+0.5
W₃	4.0+0.5
W₄	5.0+0.5

Tape and Reel Diagram

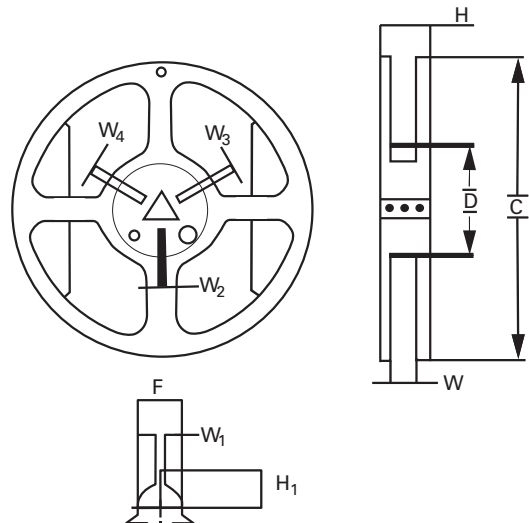
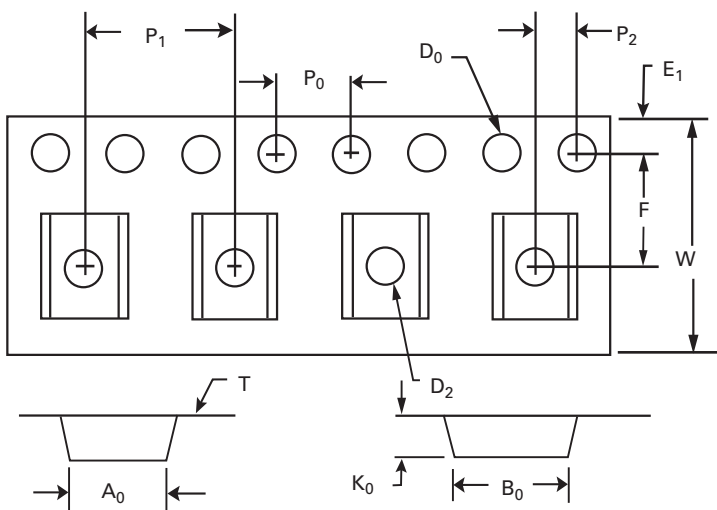

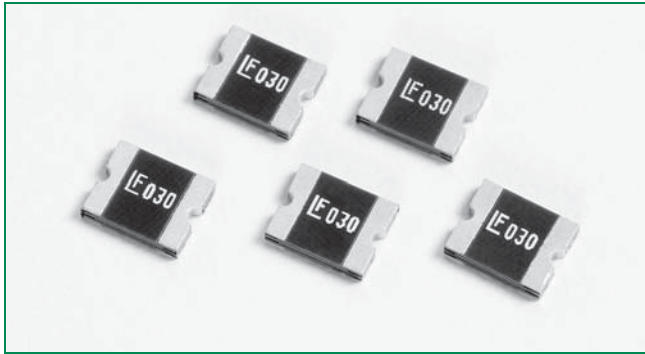

Description

The 2016L Series device provides surface mount overcurrent protection for low voltage ($\leq 60V$) applications where resettable protection is desired.



Features

- RoHS compliant and lead-free
- High voltage
- Fast response to fault currents
- Low-profile



Applications

- IEE1394 port protection
- Powered ethernet port protection (IEEE 802.3 af)
- Automotive electronic control module protection
- Low voltage telecom equipment protection

Agency Approvals

AGENCY	AGENCY FILE NUMBER
	E183209
	R50119118

Electrical Characteristics

Part Number	Marking	I_{hold} (A)	I_{trip} (A)	V_{max} (Vdc)	I_{max} (A)	P_d max. (W)	Maximum Time To Trip		Resistance			Agency Approvals	
							Current (A)	Time (Sec.)	R_{min} (Ω)	R_{typ} (Ω)	R_{1max} (Ω)		
2016L030	LF030	0.30	0.60	60	20	1.40	1.50	3.00	0.500	1.400	2.300	X	X
2016L050	LF050	0.55	1.10	60	20	1.40	2.50	5.00	0.200	0.700	1.000	X	X
2016L100	LF100	1.10	2.20	15	40	1.40	8.00	0.50	0.100	0.250	0.400	X	X
2016L100/33	LF100-33	1.10	2.20	33	40	1.40	8.00	0.50	0.100	0.250	0.400	X	X
2016L150	LF150	1.50	3.00	15	40	1.40	8.00	1.00	0.070	0.130	0.180	X	X
2016L200	LF200	2.00	4.20	6	40	1.40	8.00	3.00	0.048	0.070	0.100	X	X

I_{hold} = Hold current: maximum current device will pass without tripping in 20°C still air.

I_{trip} = Trip current: minimum current at which the device will trip in 20°C still air.

V_{max} = Maximum voltage device can withstand without damage at rated current (I_{max})

I_{max} = Maximum fault current device can withstand without damage at rated voltage (V_{max})

P_d = Power dissipated from device when in the tripped state at 20°C still air.

R_{min} = Minimum resistance of device in initial (un-soldered) state.

R_{typ} = Typical resistance of device in initial (un-soldered) state.

R_{1max} = Maximum resistance of device at 20°C measured one hour after tripping or reflow soldering of 260°C for 20 sec.

Caution: Operation beyond the specified rating may result in damage and possible arcing and flame.

Temperature Derating

Part Number	Ambient Operation Temperature								
	-40°C	-20°C	0°C	23°C	40°C	50°C	60°C	70°C	85°C
2016L030	0.45	0.40	0.35	0.30	0.25	0.23	0.20	0.18	0.14
2016L050	0.93	0.80	0.65	0.50	0.38	0.32	0.25	0.19	0.09
2016L100	1.66	1.47	1.29	1.10	0.91	0.83	0.73	0.64	0.50
2016L100/33	1.66	1.47	1.29	1.10	0.91	0.83	0.73	0.64	0.50
2016L150	2.26	2.00	1.76	1.50	1.24	1.13	1.00	0.87	0.68
2016L200	2.80	2.50	2.19	2.00	1.84	1.74	1.50	1.34	1.14

Average Time Current Curves

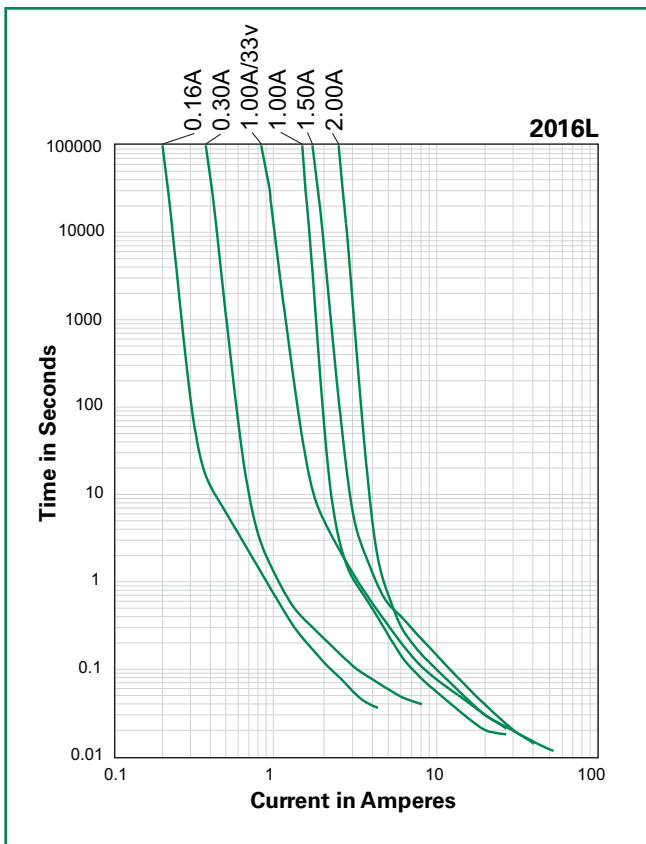

Temperature Derating Curve

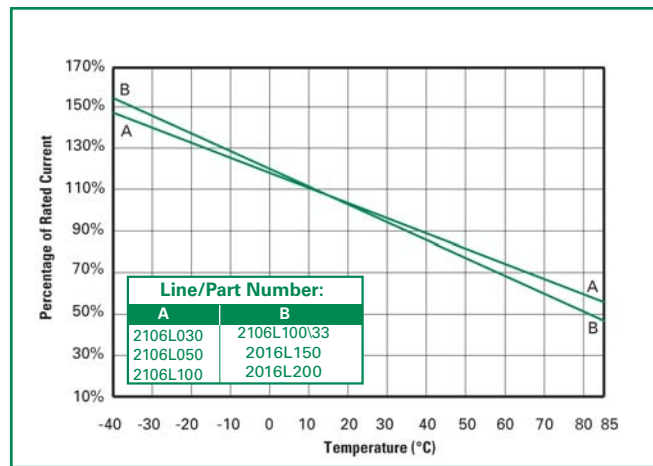

The average time current curves and Temperature Derating curve performance is affected by a number of variables, and these curves provided as guidance only. Customer must verify the performance in their application.

Soldering Parameters

Condition	Reflow
Peak Temp/ Duration Time	260°C / 10 Sec
Time above liquids (TAL) 220°C	60 Sec ~ 100 Sec
Preheat 120°C~ 180°C	50 Sec ~ 150 Sec
Storage Condition	0°C~35°C, ≤70%RH

- Recommended reflow methods: IR, vapor phase oven, hot air oven, N₂ environment for lead-free
- Recommended maximum paste thickness is 0.25mm (0.010 inch)
- Devices can be cleaned using standard industry methods and solvents.

Note: If reflow temperatures exceed the recommended profile, devices may not meet the performance requirements.

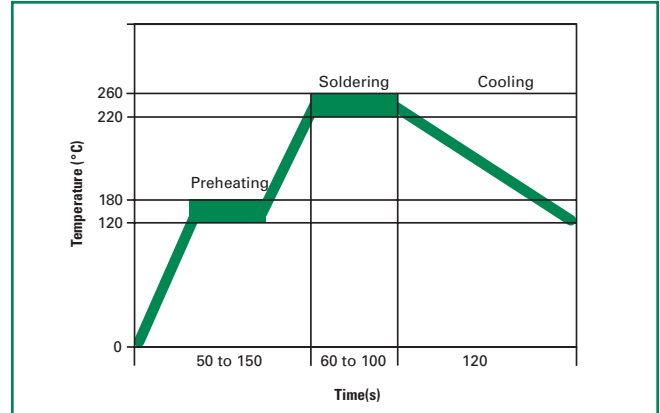

Physical Specifications

Terminal Material	Solder-Plated Copper (Solder Material: Matte Tin(Sn))
Lead Solderability	Meets EIA Specification RS186-9E, ANSI/J-STD-002 Category 3.

Environmental Specifications

Operating/Storage Temperature	-40°C to +85°C
Maximum Device Surface Temperature in Tripped State	125°C
Passive Aging	+85°C, 1000 hours -/+5% typical resistance change
Humidity Aging	+85°C, 85% R.H., 1000 hours -/+5% typical resistance change
Thermal Shock	MIL-STD-202, Method 107G +85°C/-40°C 20 times -30% typical resistance change
Solvent Resistance	MIL-STD-202, Method 215 No change
Vibration	MIL-STD-883C, Method 2007.1, Condition A No change
Moisture Sensitivity Level	Level 2, J-STD-020C

Dimensions (mm)

MARKING CODE VARIES
WITH AMPERAGE AND VOLTAGE RATING
SEE ELECTRICAL CHARACTERISTICS CHART
SHOWN ARE:
- 1.1A/15V RATING (LEFT)
- 1.1A/33V RATING (RIGHT)

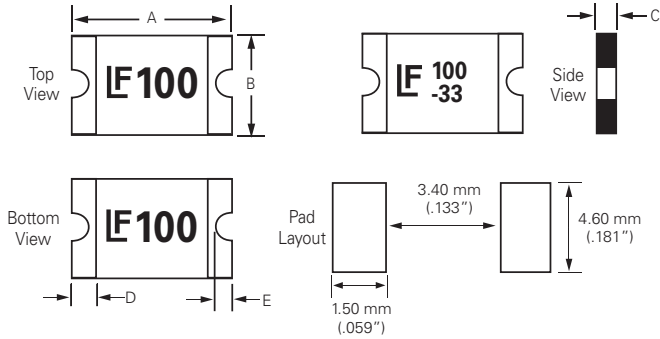

Part Number	A				B				C				D		E			
	Inches		mm		Inches		mm		Inches		mm		Inches	mm	Inches	mm	Inches	mm
	Min.	Max.	Min.	Max.	Min.	Max.	Min.	Max.	Min.	Max.	Min.	Max.	Min.	Max.	Min.	Max.	Min.	Max.
2016L030	0.19	0.21	4.72	5.44	0.15	0.17	3.7	4.43	0.03	0.05	0.75	1.25	0.01	0.30	0.01	0.03	0.25	0.65
2016L050	0.19	0.21	4.72	5.44	0.15	0.17	3.7	4.43	0.05	0.08	1.2	2	0.01	0.30	0.01	0.03	0.25	0.65
2016L100	0.19	0.21	4.72	5.44	0.15	0.17	3.7	4.43	0.02	0.03	0.5	0.75	0.01	0.30	0.01	0.03	0.25	0.65
2016L100/33	0.19	0.21	4.72	5.44	0.15	0.17	3.7	4.43	0.03	0.05	0.75	1.25	0.01	0.30	0.01	0.03	0.25	0.65
2016L150	0.19	0.21	4.72	5.44	0.15	0.17	3.7	4.43	0.03	0.06	0.75	1.55	0.01	0.30	0.01	0.03	0.25	0.65
2016L200	0.19	0.21	4.72	5.44	0.15	0.17	3.7	4.43	0.02	0.03	0.5	0.75	0.01	0.30	0.01	0.03	0.25	0.65

Part Ordering Number System

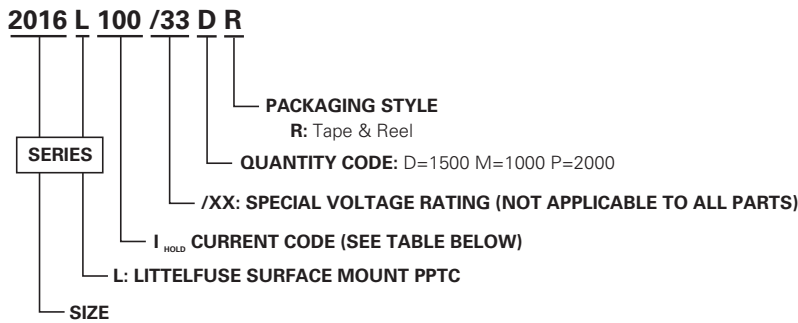

Packaging

Part Number	Ordering Number	I _{hold} (A)	I _{hold} Code	Voltage Option	Packaging Option	Quantity	Quantity & Packaging Codes
2016L030	2016L030DR	0.30	030		Tape and Reel	1500	DR
2016L050	2016L050MR	0.55	050		Tape and Reel	1000	MR
2016L100	2016L100PR	1.10	110		Tape and Reel	2000	PR
2016L100/33	2016L100/33DR	1.10	110	/33	Tape and Reel	1500	DR
2016L150	2016L150DR	1.50	150		Tape and Reel	1500	DR
2016L200	2016L200PR	2.00	200		Tape and Reel	2000	PR

Tape and Reel Specifications

TAPE SPECIFICATIONS: EIA-481-1 (mm)			
	2016L100 2016L200	2016L030 2016L100/33 2016L150	2016L050
W	12.0+/-0.30	12.0+/-0.30	12.0+/-0.30
F	5.50+/-0.05	5.50+/-0.05	5.50+/-0.05
E₁	1.75+/-0.10	1.75+/-0.10	1.75+/-0.10
D₀	1.55+/-0.05	1.55+/-0.05	1.55+/-0.05
D₁	1.50 (MIN)	1.50 (MIN)	1.50 (MIN)
P₀	4.0+/-0.10	4.0+/-0.10	4.0+/-0.10
P₁	8.0+/-0.10	8.0+/-0.10	8.0+/-0.10
P₂	2.0+/-0.05	2.0+/-0.05	2.0+/-0.05
A₀	4.40+/-0.10	4.48+/-0.10	4.45+/-0.10
B₀	5.50+/-0.10	5.40+/-0.10	5.48+/-0.10
T	0.25+/-0.10	0.25+/-0.10	0.25+/-0.10
K₀	0.80+/-0.10	1.36+/-0.10	1.86+/-0.10
<i>Leader Min.</i>	390	390	390
<i>Trailer Min.</i>	160	160	160

REEL DIMENSIONS: EIA-481-1 (mm)	
H	12.0+/-0.05
W	9.0+/-0.5
D	Ø 60+0.5
F	Ø13.0+/-0.2
C	Ø178+/-1.0
H₁	11+/-0.5
W₁	2.2+/-0.5
W₂	3.0+0.5
W₃	4.0+0.5
W₄	5.5+0.5

2016L Series

Tape and Reel Diagram

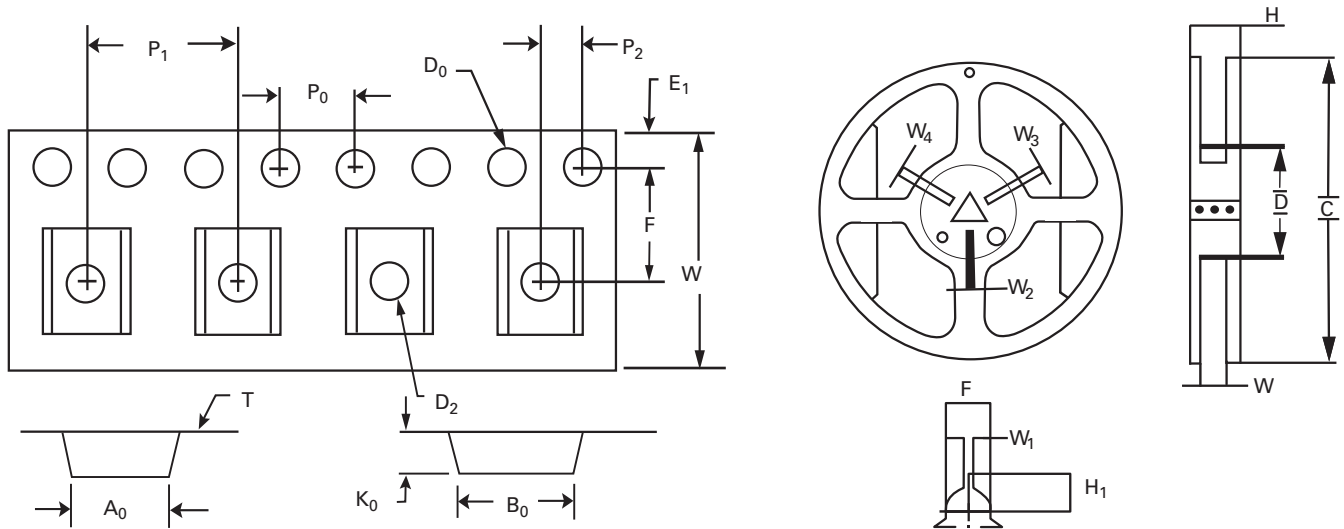

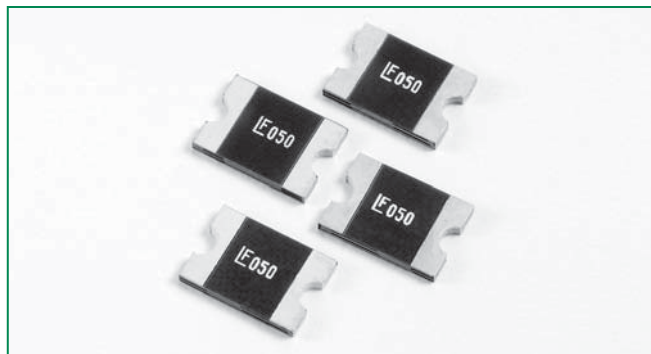

Description

The 2920L Series device provides surface mount overcurrent protection for medium voltage ($\leq 60V$) applications where resettable protection is desired.



Features

- RoHS compliant and lead-free
- High voltage
- Fast response to fault currents
- Low-profile



Applications

- IEE1394 port protection
- Powered ethernet port protection (IEEE 802.3 af)
- Automotive electronic control module protection
- Low voltage telecom equipment protection

Agency Approvals

AGENCY	AGENCY FILE NUMBER
	E183209
	R50119118

Electrical Characteristics

Part Number	Marking	I_{hold} (A)	I_{trip} (A)	V_{max} (Vdc)	I_{max} (A)	P_d max. (W)	Maximum Time To Trip		Resistance			Agency Approvals	
							Current (A)	Time (Sec.)	R_{min} (Ω)	R_{typ} (Ω)	R_{1max} (Ω)		
2920L030	LF030	0.30	0.60	60	10	1.50	1.50	3.00	1.200	3.000	4.800	X	X
2920L050	LF050	0.50	1.00	60	10	1.50	2.50	4.00	0.350	0.870	1.400	X	X
2920L075	LF075	0.75	1.50	30	40	1.50	8.00	0.30	0.350	0.670	1.000	X	X
2920L100	LF100	1.10	2.20	33	40	1.50	8.00	0.50	0.120	0.270	0.410	X	X
2920L125	LF125	1.25	2.50	15	40	1.50	8.00	2.00	0.070	0.160	0.250	X	X
2920L150	LF150	1.50	3.00	33	40	1.50	8.00	2.00	0.080	0.150	0.230	X	X
2920L185	LF185	1.85	3.70	33	40	1.50	8.00	2.50	0.065	0.110	0.150	X	X
2920L200	LF200	2.00	4.00	15	40	1.50	8.00	5.00	0.050	0.090	0.125	X	X
2920L200/24	LF200-24	2.00	4.00	24	40	1.50	8.00	5.00	0.050	0.090	0.125	X	X
2920L250	LF250	2.50	5.00	15	40	1.50	8.00	10.00	0.035	0.060	0.085	X	X
2920L260	LF260	2.60	5.00	6	40	1.50	8.00	10.00	0.025	0.050	0.075	X	X
2920L300	LF300	3.00	5.00	6	40	1.50	8.00	20.00	0.015	0.033	0.048	X	X
2920L300/15	LF300-15	3.00	5.00	15	40	1.50	8.00	20.00	0.015	0.033	0.048	X	X

I_{hold} = Hold current: maximum current device will pass without tripping in 20°C still air.

I_{trip} = Trip current: minimum current at which the device will trip in 20°C still air.

V_{max} = Maximum voltage device can withstand without damage at rated current (I_{max})

I_{max} = Maximum fault current device can withstand without damage at rated voltage (V_{max})

P_d = Power dissipated from device when in the tripped state at 20°C still air.

R_{min} = Minimum resistance of device in initial (un-soldered) state.

R_{typ} = Typical resistance of device in initial (un-soldered) state.

R_{1max} = Maximum resistance of device at 20°C measured one hour after tripping or reflow soldering of 260°C for 20 sec.

Caution: Operation beyond the specified rating may result in damage and possible arcing and flame.

Temperature Derating

Part Number	Ambient Operation Temperature								
	-40°C	-20°C	0°C	23°C	40°C	50°C	60°C	70°C	85°C
	Hold Current (A)								
2920L030	0.45	0.40	0.35	0.30	0.25	0.23	0.20	0.17	0.14
2920L050	0.76	0.67	0.59	0.50	0.42	0.38	0.33	0.29	0.23
2920L075	1.13	1.01	0.88	0.75	0.62	0.56	0.50	0.44	0.34
2920L100	1.66	1.47	1.29	1.10	0.91	0.83	0.73	0.64	0.50
2920L125	1.89	1.68	1.46	1.25	1.04	0.94	0.83	0.73	0.56
2920L150	2.27	2.01	1.76	1.50	1.25	1.13	1.00	0.87	0.74
2920L185	2.80	2.47	2.17	1.85	1.54	1.39	1.22	1.07	0.85
2920L200	3.02	2.68	2.34	2.00	1.66	1.50	1.32	1.16	0.90
2920L200/24	3.14	2.77	2.42	2.00	1.73	1.56	1.38	1.20	0.98
2920L250	3.78	3.35	2.93	2.50	2.08	1.88	1.65	1.45	1.13
2920L260	3.64	3.25	2.91	2.60	2.26	2.08	1.95	1.74	1.48
2920L300	4.53	4.02	3.51	3.00	2.52	2.26	1.99	1.75	1.34
2920L300/15	4.20	3.85	3.44	3.00	2.69	2.50	2.31	2.12	1.83

Average Time Current Curves

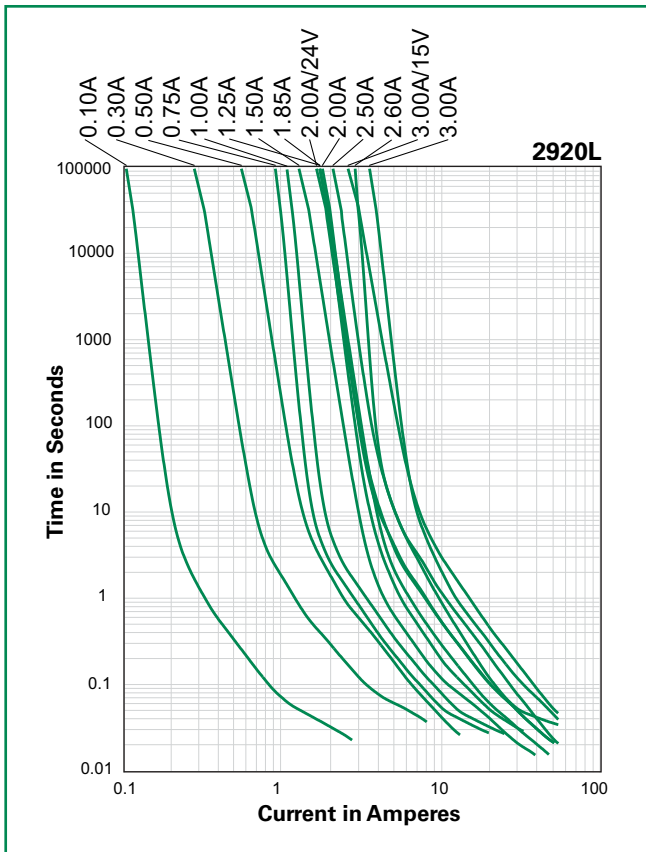

Temperature Derating Curve

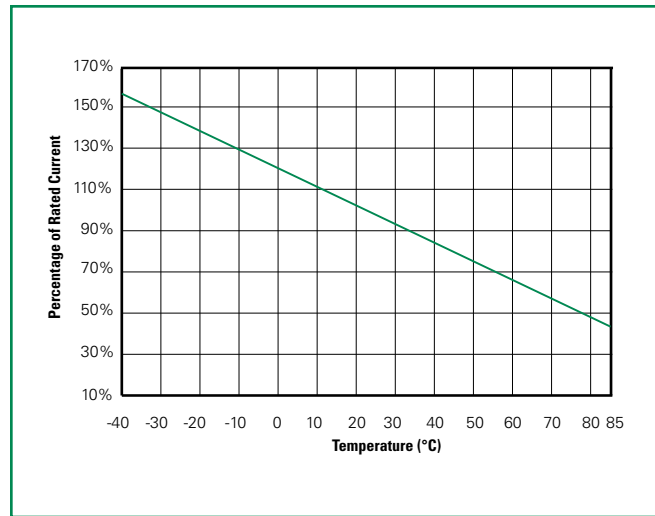

The average time current curves and Temperature Derating curve performance is affected by a number of variables, and these curves provided as guidance only. Customer must verify the performance in their application.

Soldering Parameters

Condition	Reflow
Peak Temp/ DurationTime	260°C / 10 Sec
Time above liquids (TAL) 220°C	60 Sec ~ 100 Sec
Preheat 120°C~ 180°C	50 Sec ~ 150 Sec
Storage Condition	0°C~35°C, ≤70%RH

- Recommended reflow methods: IR, vapor phase oven, hot air oven, N₂ environment for lead-free
- Recommended maximum paste thickness is 0.25mm (0.010 inch)
- Devices can be cleaned using standard industry methods and solvents.

Note: If reflow temperatures exceed the recommended profile, devices may not meet the performance requirements.

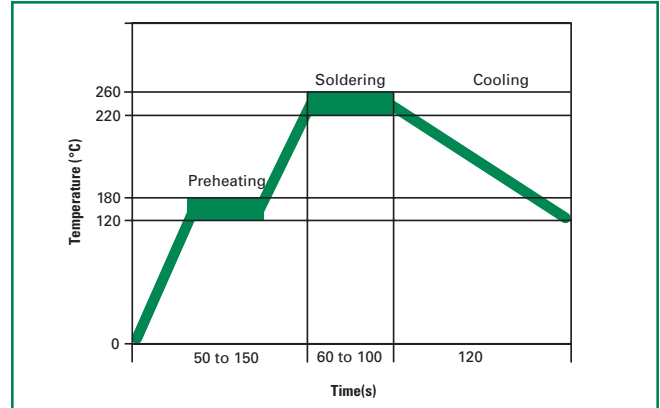

Physical Specifications

Terminal Material	Solder-Plated Copper (Solder Material: Matte Tin(Sn))
Lead Solderability	Meets EIA Specification RS186-9E, ANSI/J-STD-002 Category 3.

Environmental Specifications

Operating/Storage Temperature	-40°C to +85°C
Maximum Device Surface Temperature in Tripped State	125°C
Passive Aging	+85°C, 1000 hours -/+5% typical resistance change
Humidity Aging	+85°C, 85%, R.H., 1000 hours -/+5% typical resistance change
Thermal Shock	MIL-STD-20 2, Method 107G +85°C/-40°C 20 times -30% typical resistance change
Solvent Resistance	MIL-STD-202, Method 215
Vibration	MIL-STD-883C, Method 2007.1, Condition A
Moisture Sensitivity Level	Level 2, J-STD-020C

Dimensions (mm)

MARKING CODE VARIES
WITH AMPERAGE AND VOLTAGE RATING
(SEE ELECTRICAL CHARACTERISTIC TABLE)
SHOWN ARE:
- 1.5A/33V RATING (LEFT)
- 2.0A/24V RATING (RIGHT)

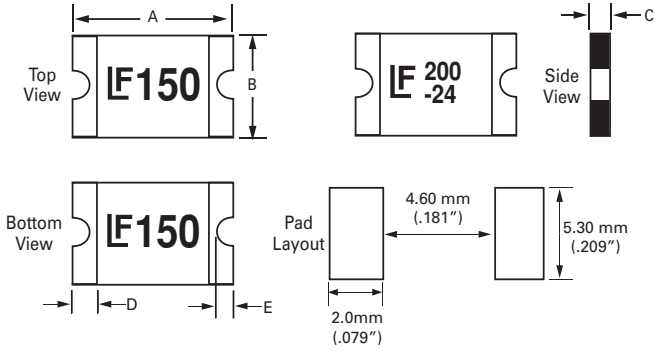

Part Number	A				B				C				D		E			
	Inches		mm		Inches		mm		Inches		mm		Inches	mm	Inches		mm	
	Min.	Max.	Min.	Max.	Min.	Max.	Min.	Max.	Min.	Max.	Min.	Max.	Min.	Min.	Min.	Max.	Min.	Max.
2920L030	0.26	0.31	6.73	7.98	0.19	0.21	4.8	5.44	0.03	0.05	0.75	1.25	0.01	0.3	0.01	0.08	0.25	2
2920L050	0.26	0.31	6.73	7.98	0.19	0.21	4.8	5.44	0.03	0.05	0.75	1.25	0.01	0.3	0.01	0.08	0.25	2
2920L075	0.26	0.31	6.73	7.98	0.19	0.21	4.8	5.44	0.03	0.05	0.75	1.25	0.01	0.3	0.01	0.08	0.25	2
2920L100	0.26	0.31	6.73	7.98	0.19	0.21	4.8	5.44	0.02	0.04	0.55	1	0.01	0.3	0.01	0.08	0.25	2
2920L125	0.26	0.31	6.73	7.98	0.19	0.21	4.8	5.44	0.02	0.04	0.55	1	0.01	0.3	0.01	0.08	0.25	2
2920L150	0.26	0.31	6.73	7.98	0.19	0.21	4.8	5.44	0.03	0.05	0.75	1.25	0.01	0.3	0.01	0.08	0.25	2
2920L185	0.26	0.31	6.73	7.98	0.19	0.21	4.8	5.44	0.03	0.05	0.75	1.25	0.01	0.3	0.01	0.08	0.25	2
2920L200	0.26	0.31	6.73	7.98	0.19	0.21	4.8	5.44	0.03	0.05	0.75	1.25	0.01	0.3	0.01	0.08	0.25	2
2920L200/24	0.26	0.31	6.73	7.98	0.19	0.21	4.8	5.44	0.03	0.05	0.75	1.25	0.01	0.3	0.01	0.08	0.25	2
2920L250	0.26	0.31	6.73	7.98	0.19	0.21	4.8	5.44	0.03	0.05	0.75	1.25	0.01	0.3	0.01	0.08	0.25	2
2920L260	0.26	0.31	6.73	7.98	0.19	0.21	4.8	5.44	0.02	0.04	0.55	1	0.01	0.3	0.01	0.08	0.25	2
2920L300	0.26	0.31	6.73	7.98	0.19	0.21	4.8	5.44	0.03	0.05	0.75	1.25	0.01	0.3	0.01	0.08	0.25	2
2920L300/15	0.26	0.31	6.73	7.98	0.19	0.21	4.8	5.44	0.03	0.05	0.75	1.25	0.01	0.3	0.01	0.08	0.25	2

Part Ordering Number System

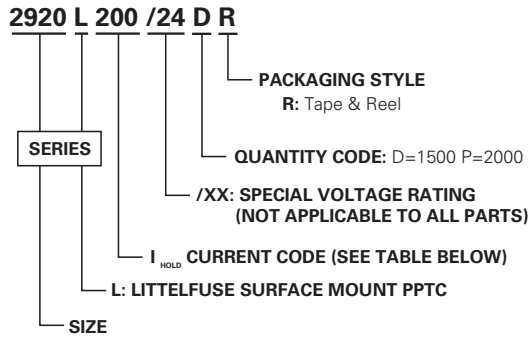

Packaging

Part Number	Ordering Number	I _{hold} (A)	I _{hold} Code	Voltage Option	Packaging Option	Quantity	Quantity & Packaging Codes
2920L030	2920L030DR	0.30	030		Tape and Reel	1500	DR
2920L050	2920L050DR	0.50	050		Tape and Reel	1500	DR
2920L075	2920L075DR	0.75	075		Tape and Reel	1500	DR
2920L100	2920L100PR	1.10	100		Tape and Reel	2000	PR
2920L125	2920L125PR	1.25	125		Tape and Reel	2000	PR
2920L150	2920L150DR	1.50	150		Tape and Reel	1500	DR
2920L185	2920L185DR	1.85	185		Tape and Reel	1500	DR
2920L200	2920L200DR	2.00	200		Tape and Reel	1500	DR
2920L200/24	2920L200/24DR	2.00	200	/24	Tape and Reel	1500	DR
2920L250	2920L250DR	2.50	250		Tape and Reel	1500	DR
2920L260	2920L260PR	2.60	260		Tape and Reel	2000	PR
2920L300	2920L300DR	3.00	300		Tape and Reel	1500	DR
2920L300/15	2920L300/15DR	3.00	300	/15	Tape and Reel	1500	DR

Tape and Reel Specifications

TAPE SPECIFICATIONS: EIA-481-1 (mm)			
	2920L030, 2920L050, 2920L075	2920L100, 2920L125, 2920L260	2920L150, 2920L185, 2920L200, 2920L250, 2920L200/24, 2920L300, 2920L300/15
W	16.0+/-0.30	16.0+/-0.30	16.0+/-0.30
F	7.5+/-0.05	7.5+/-0.05	7.5+/-0.05
E₁	1.75+/-0.10	1.75+/-0.10	1.75+/-0.10
D₀	1.55+/-0.05	1.55+/-0.05	1.55+/-0.05
D₁	1.5+/-0.10	1.5+/-0.10	1.5+/-0.10
P₀	4.0+/-0.10	4.0+/-0.10	4.0+/-0.10
P₁	8.0+/-0.10	8.0+/-0.10	8.0+/-0.10
P₂	2.0+/-0.05	2.0+/-0.05	2.0+/-0.05
A₀	5.45+/-0.10	5.45+/-0.10	5.45+/-0.10
B₀	7.65+/-0.10	7.65+/-0.10	7.65+/-0.10
T	0.25+/-0.10	0.25+/-0.10	0.25+/-0.10
K₀	1.25+/-0.10	1.00+/-0.10	1.45+/-0.10
<i>Leader min.</i>	390	390	390
<i>Trailer min.</i>	160	160	160

REEL DIMENSIONS: EIA-481-1 (mm)	
H	16.0+/-0.2
W	13.2+/-1.5
D	Ø 60.2+/-0.5
F	Ø 13.0+/-0.5
C	Ø 178+/-1.0
H₁	11+/-0.5
W₁	2.5+0.5
W₂	3.0+0.5
W₃	4.0+0.5

Tape and Reel Diagram

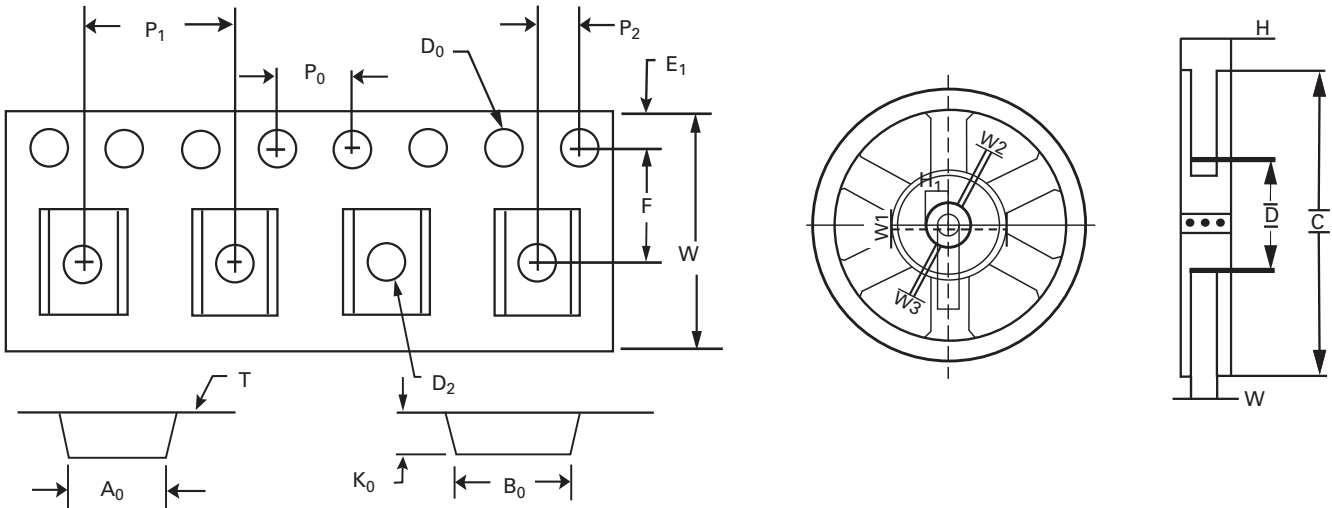



Description

The 250S High Voltage Radial device is a Polymer-based PTC suitable to protect telephony equipment against lightning and power cross strikes. The 250S Series is fully compatible with telecommunications standards.

PRELIMINARY DATA SHEET: This product is scheduled for release by end of 2008 and specifications may change. Please refer to www.littelfuse.com/series/250S.html for the current information.

Features

- RoHS Compliant, Directive 2002/95/EC
- Low resistance
- Compatible with telecom standards
- Helps meet ITU K.20, K.21/Telcordia standards
- Excellent solder joint inspectability
- High voltage

Applications

- Telecommunications
- Networking
- ISDN Equipment
- XSDN Equipment

Agency Approvals

AGENCY	AGENCY FILE NUMBER
	Pending

Electrical Characteristics

Part Number	I _{hold} (A)	I _{trip} (A)	V _{max} (V _{int} /V _{op})	I _{max} (A)	P _d typ. (W)	Time to Trip at 1A		Resistance			Agency Approvals
						Typical (Sec.)	Maximum (Sec.)	R _{min} (Ω)	R _{max} (Ω)	R _{1max} (Ω)	
250S130	0.13	0.26	250/60	3	1.2	0.9	4.0	4.0	13	20	–
250S130-RA	0.13	0.26	250/60	3	1.2	1.4	4.0	6.5	10	15	–
250S130-RB	0.13	0.26	250/60	3	1.2	0.7	4.0	9	13	20	–
250S130-RC	0.13	0.26	250/60	3	1.2	1.1	4.0	7	11	17	–

I_{hold} = Hold current: maximum current device will pass without tripping in 23°C still air.
 I_{trip} = Trip current: minimum current at which the device will trip in 23°C still air.
 V_{int} = Maximum voltage the device can withstand without damage at rated current (I_{max})
 V_{op} = The device regular operation voltage
 I_{max} = Maximum fault current device can withstand without damage at rated voltage (V_{max})
 P_d = Power dissipated from device when in the tripped state at 23°C still air.

R_{min} = Minimum resistance of device in initial (un-soldered) state.
 R_{max} = Maximum resistance of device in initial (un-soldered) state.
 R_{1max} = Maximum resistance of device at 20°C measured one hour after tripping.
Caution: Operation beyond the specified rating may result in damage and possible arcing and flame.

Temperature Derating

	Ambient Operation Temperature								
	-40°C	-20°C	0°C	23°C	40°C	50°C	60°C	70°C	85°C
Part Number	Hold Current (A)								
250S130	0.21	0.19	0.17	0.13	0.11	0.10	0.09	0.07	0.05

Average Time Current Curves

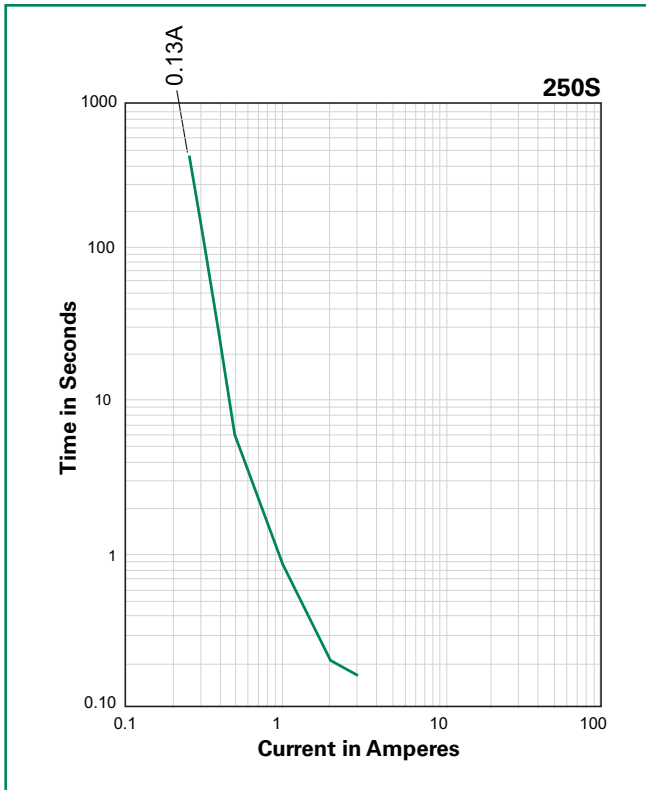

Temperature Derating Curve

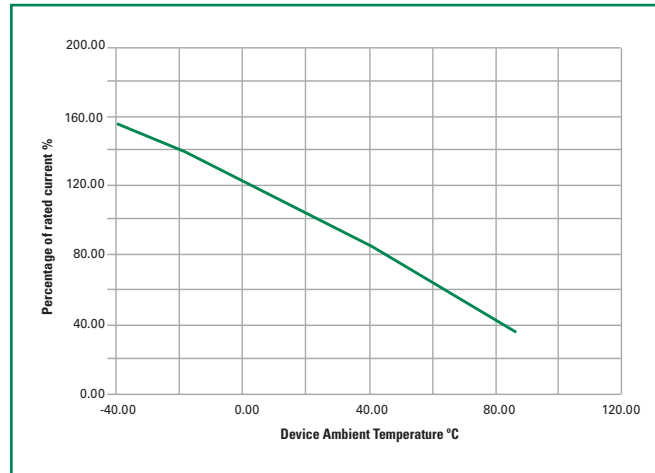

The average time current curves and Temperature Derating curve performance is affected by a number of variables, and these curves provided as guidance only. Customer must verify the performance in their application.

Agency Specification Selection Guide For Telecom and Networking Applications

Product	Lightning	Power Cross
250S130		
250S130-RA	ITU K.20/21/45 –	ITU K.20/21/45 –
250S130-RB	1.5kV 10/700µs	230Vac, 10Ω
250S130-RC		

Protection Application Guide

Region/ Specification	Application	Device Selection
South America/ Asia/Europe ITU K.45	Access network equipment Remote terminal Repeaters WAN equipment Cross –connect	250S130 250S130-RA 250S130-RB 250S130-RC
South America/ Asia/Europe ITU K.21	Customer and IT equipment Analog modems ADSL, xDSL Phone sets, PBX systems Internet appliances POS terminals	250S130 250S130-RA 250S130-RB 250S130-RC
South America/ Asia/Europe ITU K.20	Central Office POTS/ISDN linecards T1/E1/J1 linecards ADSL/VDSL splitters CSU/DSU	250S130 250S130-RA 250S130-RB 250S130-RC

Soldering Parameters

Profile Feature		Pb-Free Assembly
Average Ramp-Up Rate ($T_{s(max)}$ to T_p)		3°C/second max
Pre Heat:	Temperature Min ($T_{s(min)}$)	150°C
	Temperature Max ($T_{s(max)}$)	200°C
	Time (Min to Max) (t_s)	60 – 180 secs
Time Maintained Above:	Temperature (T_L)	217°C
	Temperature (t_L)	60 – 150 seconds
Peak / Classification Temperature (T_p)		260 ^{+0/-5} °C
Time within 5°C of actual peak Temperature (t_p)		20 – 40 seconds
Ramp-down Rate		6°C/second max
Time 25°C to peak Temperature (T_p)		8 minutes Max.

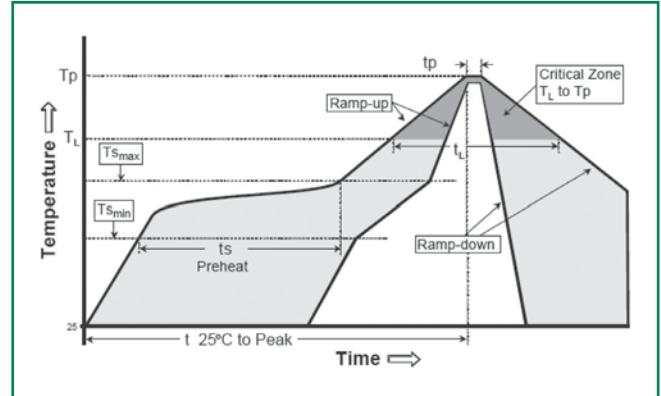

- All temperature refer to topside of the package, measured on the package body surface
- If reflow temperature exceeds the recommended profile, devices may not meet the performance requirements
- Recommended reflow methods: IR, vapor phase oven, hot air oven, N₂ environment for lead
- Recommended maximum paste thickness is 0.25mm (0.010inch)
- Devices can be cleaned using standard industry methods and solvents
- Devices can be reworked using the standard industry practices

Physical Specifications

Terminal Material	Solder-Plated Copper (Solder Material: Matte Tin(Sn))
Lead Solderability	Meets EIA Specification RS186-9E, ANSI/J-STD-002 Category 3.

Environmental Specifications

Operating/Storage Temperature	-40°C to +85°C
Maximum Device Surface Temperature in Tripped State	125°C +/-10°C
Passive Aging	+85°C, 1000 hours
Humidity Aging	+85°C, 85%, R.H., 1000 hours
Thermal Shock	MIL-STD-202F, Method 107G +125°C to -55°C 10 times
Solvent Resistance	MIL-STD-202, Method 215F
Moisture Sensitivity Level	Level 2, J-STD-020C

Dimensions

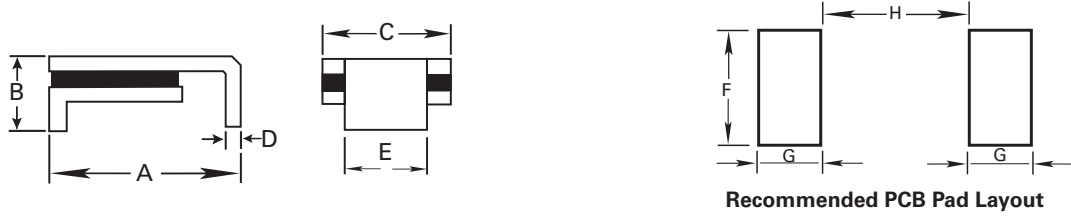

Part Number	A		B		C		D		E		Physical Characteristics Material	F		G		H	
	Inch	mm	Inch	mm	Inch	mm	Inch	mm	Inch	mm		Inch	mm	Inch	mm	Inch	mm
	Max.	Max.	Max.	Max.	Max.	Max.	Max.	Max.	Max.	Max.		Max.	Max.	Max.	Max.	Max.	Max.
250S130	0.37	9.4	0.15	3.7	0.29	7.4	0.016	0.4	0.15	3.8	Sn/Ni/Cu	0.18	4.6	0.07	1.8	0.24	6.1
250S130-RA	0.37	9.4	0.15	3.7	0.29	7.4	0.016	0.4	0.15	3.8	Sn/Ni/Cu	0.18	4.6	0.07	1.8	0.24	6.1
250S130-RB	0.37	9.4	0.15	3.7	0.29	7.4	0.016	0.4	0.15	3.8	Sn/Ni/Cu	0.18	4.6	0.07	1.8	0.24	6.1
250S130-RC	0.37	9.4	0.15	3.7	0.29	7.4	0.016	0.4	0.15	3.8	Sn/Ni/Cu	0.18	4.6	0.07	1.8	0.24	6.1

Part Ordering Number System

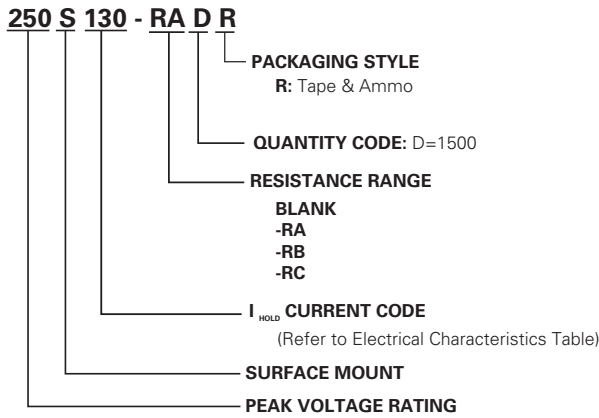

Packaging

Part Number	Ordering Number	I _{hold} (A)	I _{hold} Code	Packaging Option	Quantity	Quantity & Packaging Code
250S130	250S130DR	0.13	130	Tape and Reel	1500	DR
250S130-RA	250S130-RADR	0.13	130	Tape and Reel	1500	DR
250S130-RB	250S130-RBDR	0.13	130	Tape and Reel	1500	DR
250S130-RC	250S130-RCDR	0.13	130	Tape and Reel	1500	DR

Tape and Reel Specifications

TAPE SPECIFICATIONS: EIA-481-1 (mm)	
W	16 +/-0.30
F	7.5 +/-0.05
E₁	1.75 +/-0.10
D₀	1.5 +/-0.05
D₁	1.00(MIN)
P₀	4.00 +/-0.10
P₁	12.00 +/-0.10
P₂	2.00 +/-0.05
A₀	6.9 +/-0.10
B₀	9.6 +/-0.10
T_{max}	0.4 +/-0.10
K₀	3.4 +/-0.15
Leader Min.	300
Trailer Min.	300

REEL DIMENSIONS: EIA-481-1 (mm)	
H	22.4 +/-0.05
W	16.4 .0 +0/+2
D	Ø60+0.5
F	Ø13.0+/-0.2
C	Ø340+/-1.0
H₁	11+/-0.5
W₁	2.2+/-0.5
W₂	3.0+0.5
W₃	4.0+0.5
W₄	5.5+0.5

Tape and Reel Diagram

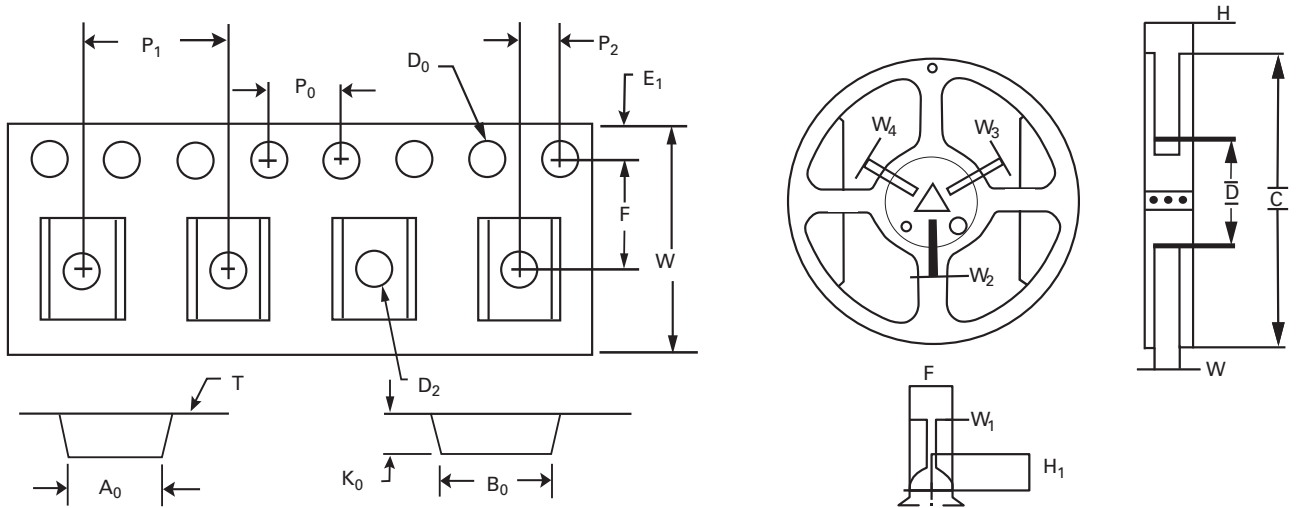

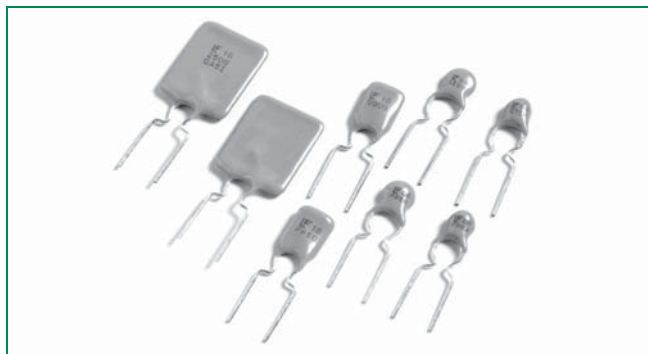

Description

- The USBR Series radial leaded device is designed to provide overcurrent protection for USB applications where space is not a concern.



Features

- RoHS compliant and lead-free
- Fast time-to-trip
- Meets all USB protection requirements
- 40A short circuit rating
- Operating voltages of 6-16V



Applications

- Computers & peripherals
- Any USB application

Agency Approvals

AGENCY	AGENCY FILE NUMBER
	E183209
	R50119318

Electrical Characteristics

Part Number	I _{hold} (A)	I _{trip} (A)	V _{max} (Vdc)	I _{max} (A)	P _d max. (W)	Maximum Time To Trip		Resistance		Agency Approvals	
						Current (A)	Time (Sec.)	R _{min} (Ω)	R _{1max} (Ω)		
06R075B	0.75	1.30	6	40	0.3	8.00	0.4	0.100	0.230	X	X
06R120B	1.20	2.00	6	40	0.6	8.00	0.5	0.065	0.140	X	X
06R155B	1.55	2.70	6	40	0.6	7.75	2.2	0.040	0.100	X	X
16R090B	0.90	1.80	16	40	0.6	8.00	1.2	0.070	0.180	X	X
16R110B	1.10	2.20	16	40	0.7	8.00	2.3	0.050	0.140	X	X
16R135B	1.35	2.70	16	40	0.8	8.00	4.5	0.040	0.120	X	X
16R160B	1.60	3.20	16	40	0.9	8.00	9.0	0.030	0.110	X	X
16R185B	1.85	3.70	16	40	1.0	8.00	10.0	0.030	0.090	X	X
16R250B	2.50	5.00	16	40	1.2	8.00	40.0	0.020	0.060	X	X

I_{hold} = Hold current: maximum current device will pass without tripping in 20°C still air.
 I_{trip} = Trip current: minimum current at which the device will trip in 20°C still air.
 V_{max} = Maximum voltage device can withstand without damage at rated current (I_{max})
 I_{max} = Maximum fault current device can withstand without damage at rated voltage (V_{max})
 P_d = Power dissipated from device when in the tripped state at 20°C still air.

R_{min} = Minimum resistance of device in initial (un-soldered) state.
 R_{typ} = Typical resistance of device in initial (un-soldered) state.
 R_{1max} = Maximum resistance of device at 20°C measured one hour after tripping or reflow soldering of 260°C for 20 sec.

Caution: Operation beyond the specified rating may result in damage and possible arcing and flame.

Temperature Derating

Part Number	Ambient Operation Temperature								
	-40°C	-20°C	0°C	23°C	40°C	50°C	60°C	70°C	85°C
	Hold Current (A)								
06R075B	1.05	0.95	0.85	0.75	0.65	0.60	0.55	0.50	0.43
06R120B	1.69	1.52	1.36	1.20	1.04	0.96	0.88	0.80	0.68
06R155B	2.17	1.96	1.75	1.55	1.34	1.24	1.13	1.03	0.88
16R090B	1.31	1.17	1.04	0.90	0.75	0.69	0.61	0.55	0.47
16R110B	1.60	1.43	1.27	1.10	1.00	0.92	0.75	0.67	0.57
16R135B	1.96	1.76	1.55	1.35	1.12	1.04	0.92	0.82	0.70
16R160B	2.32	2.08	1.84	1.60	1.33	1.23	1.09	0.98	0.83
16R185B	2.68	2.41	2.13	1.85	1.54	1.42	1.26	1.13	0.96
16R250B	3.63	3.25	2.88	2.50	2.08	1.93	1.70	1.53	1.30

Average Time Current Curves

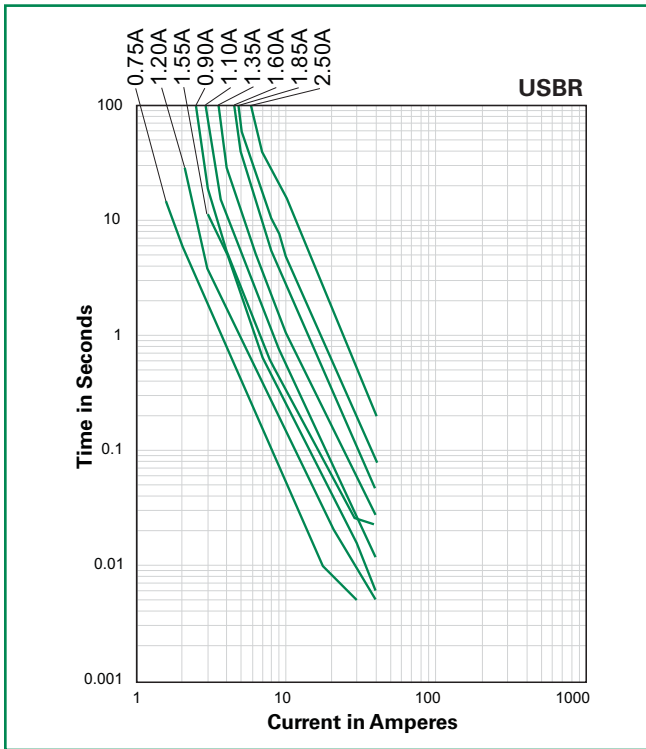

Temperature Derating Curve

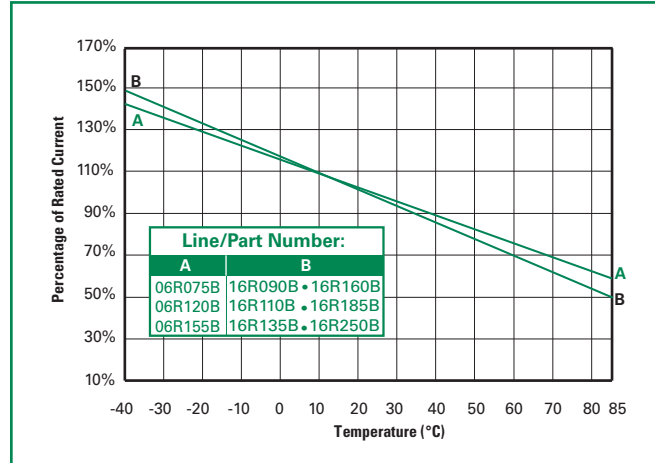

The average time current curves and Temperature Derating curve performance is affected by a number of variables, and these curves provided as guidance only. Customer must verify the performance in their application.

Soldering Parameters

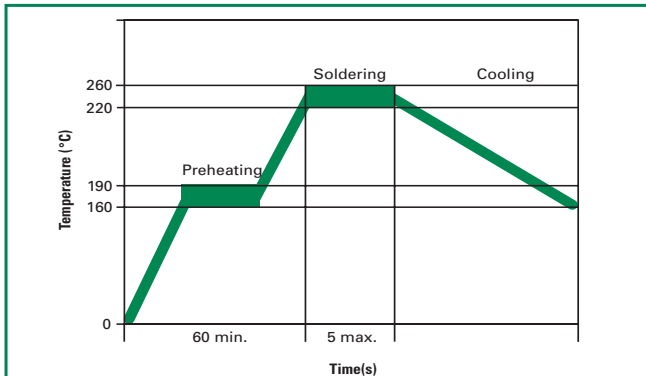

Pre-Heating Zone	Refer to the condition recommended by the flux manufacturer. Max. ramping rate should not exceed 4°C/Sec.
Soldering Zone	Max. solder temperature should not exceed 260°C
Cooling Zone	Cooling by natural convection in air.

Physical Specifications

Lead Material	.90-2.50A: Tin-plated Copper clad steel .75A: Tin-plated Copper
Soldering Characteristics	Solderability per MIL-STD-202, Method 208E
Insulating Material	Cured, flame retardant epoxy polymer meets UL 94V-0 requirements.
Device Labeling	Marked with 'LF', voltage, current rating, and date code.

Environmental Specifications

Operating/Storage Temperature	-40°C to +85°C
Maximum Device Surface Temperature in Tripped State	125°C
Passive Aging	+85°C, 1000 hours -/+5% typical resistance change
Humidity Aging	+85°C, 85% R.H., 1000 hours -/+5% typical resistance change
Thermal Shock	+85°C to -40°C 10 times -/+5% typical resistance change
Solvent Resistance	MIL-STD-202, Method 215F
Moisture Sensitivity Level	Level 2, J-STD-020C

Dimensions (mm)

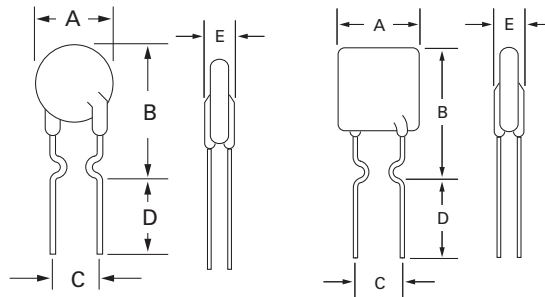
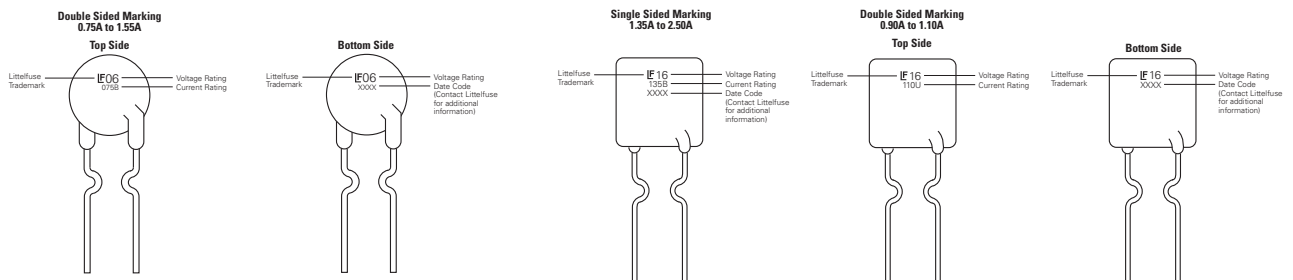

Figure 1

Figure 2

Part Number	Figure	A		B		C		D		E		Physical Characteristics		
		Inches	mm	Inches	mm	Inches	mm	Inches	mm	Inches	mm	Lead (dia)	Material	
		Max.	Max.	Max.	Max.	Typ.	Typ.	Min.	Min.	Max.	Max.			
06R075B	1	0.27	6.9	0.45	11.4	0.20	5.1	0.30	7.6	0.12	3	0.020	0.51	Sn/Cu
06R120B	1	0.27	6.9	0.46	11.7	0.20	5.1	0.30	7.6	0.12	3	0.020	0.51	Sn/CuFe
06R155B	1	0.27	6.9	0.46	11.7	0.20	5.1	0.30	7.6	0.12	3	0.020	0.51	Sn/CuFe
16R090B	2	0.29	7.4	0.48	12.2	0.20	5.1	0.30	7.6	0.12	3	0.020	0.51	Sn/CuFe
16R110B	2	0.29	7.4	0.56	14.2	0.20	5.1	0.30	7.6	0.12	3	0.020	0.51	Sn/CuFe
16R135B	2	0.35	8.9	0.53	13.5	0.20	5.1	0.30	7.6	0.12	3	0.020	0.51	Sn/CuFe
16R160B	2	0.35	8.9	0.60	15.2	0.20	5.1	0.30	7.6	0.12	3	0.020	0.51	Sn/CuFe
16R185B	2	0.40	10.2	0.62	15.7	0.20	5.1	0.30	7.6	0.12	3	0.020	0.51	Sn/CuFe
16R250B	2	0.45	11.4	0.72	18.3	0.20	5.1	0.30	7.6	0.12	3	0.020	0.51	Sn/CuFe

Part Marking System



Tape and Reel Specifications – RLD06P075BF, RLD06P120BF, RLD06P155BF

Devices taped using EIA468-B/IE286-2 standards. See table below and Figures 1 and 2 for details.

Dimension	EIA Mark	IEC Mark	Dimensions	
			Dim. (mm)	Tol. (mm)
Carrier tape width	W	W	18	-0.5 / +1.0
Hold down tape width: 06R075B-06R155B	W₄	W₀	11	min.
Top distance between tape edges	W₆	W₂	3	max.
Sprocket hole position	W₅	W₁	9	-0.5 / +0.75
Sprocket hole diameter*	D₀	D₀	4	-/+ 0.32
Abscissa to plane(straight lead)	H	H	18.5	-/+ 3.0
Abscissa to plane(kinked lead)	H₀	H₀	16	-/+ 0.5
Abscissa to top 06R075B-06R155B	H₁	H₁	32.2	max.
Overall width w/o lead protrusion 06R075B-06R155B	C₁		42.5	max.
Overall width w/ lead protrusion 06R075B-06R155B	C₂		43.2	max.
Lead protrusion	L₁	I₁	1.0	max.
Protrusion of cut out	L	L	11	max.
Protrusion beyond hold-down tape	I₂	I₂	Not specified	
Sprocket hole pitch 06R075B-06R155B	P₀	P₀	12.7	-/+ 0.35
Pitch tolerance			20 consecutive	-/+ 1
Device pitch: 06R075B-06R155B			12.7	
Tape thickness	t	t	0.9	max.
Tape thickness with splice 06R075B-06R155B	t₁		2.0	max.
Splice sprocket hole alignment			0	-/+ 0.3
Body lateral deviation	Δh	Δh	0	-/+ 1.0
Body tape plane deviation	Δp	Δp	0	-/+ 1.3
Ordinate to adjacent component lead*	P₁	P₁	3.81	-/+ 1.0
Lead spacing* 06R075B-06R155B	F	F	5.08	-/+ 0.8
Reel width 06R075B-06R155B	w₂	w	56	max.
Reel diameter	a	d	370	max.
Space between flanges less device	w₁		4.75	-/+ 3.25
Arbor hole diameter	c	f	26	-/+ 12.0
Core diameter	n	h	91	max.
Box			56/372/372	max.
Consecutive missing places			None	
Empty places per reel			0.1% max.	
Reel width: 06R075B-16R250B	w₂	w	63.5	max.
Reel diameter	a	d	370	max.
Space between flanges less device*	w₁		4.75	-3.25 / +9.25
Arbor hole diameter	c	f	26	-/+ 12.0
Core diameter*	n	h	91	max.
Box			56/372/372	max.
Consecutive missing places			None	
Empty places per reel			0.1% max.	

*Differs from EIA specification.

Tape and Reel Diagram

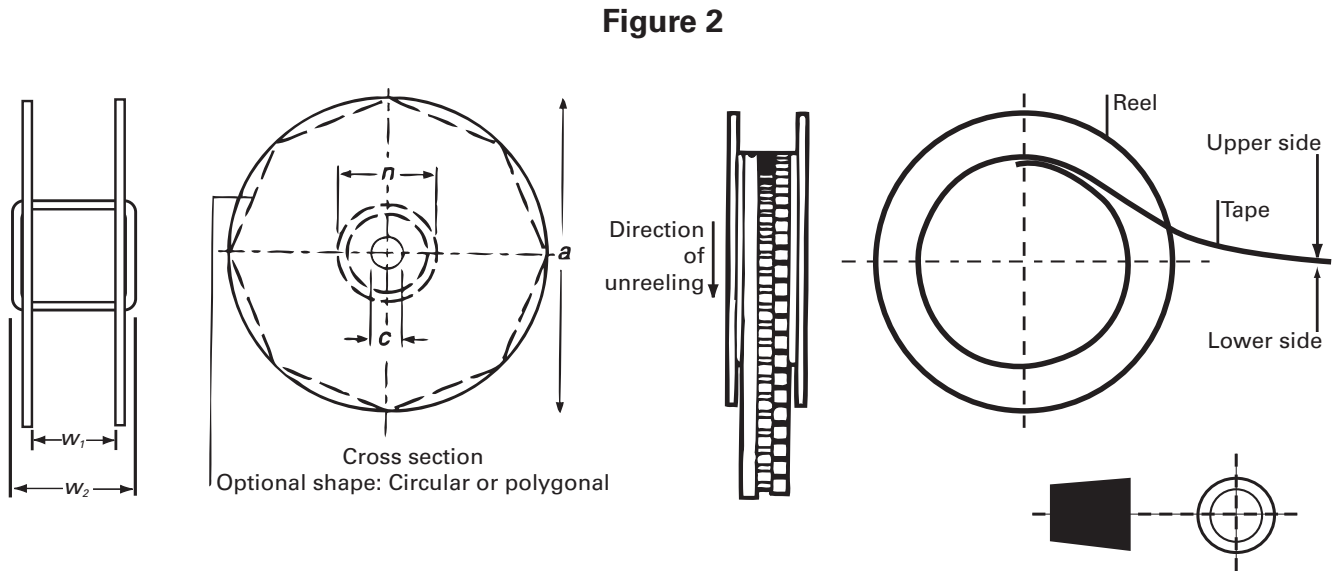
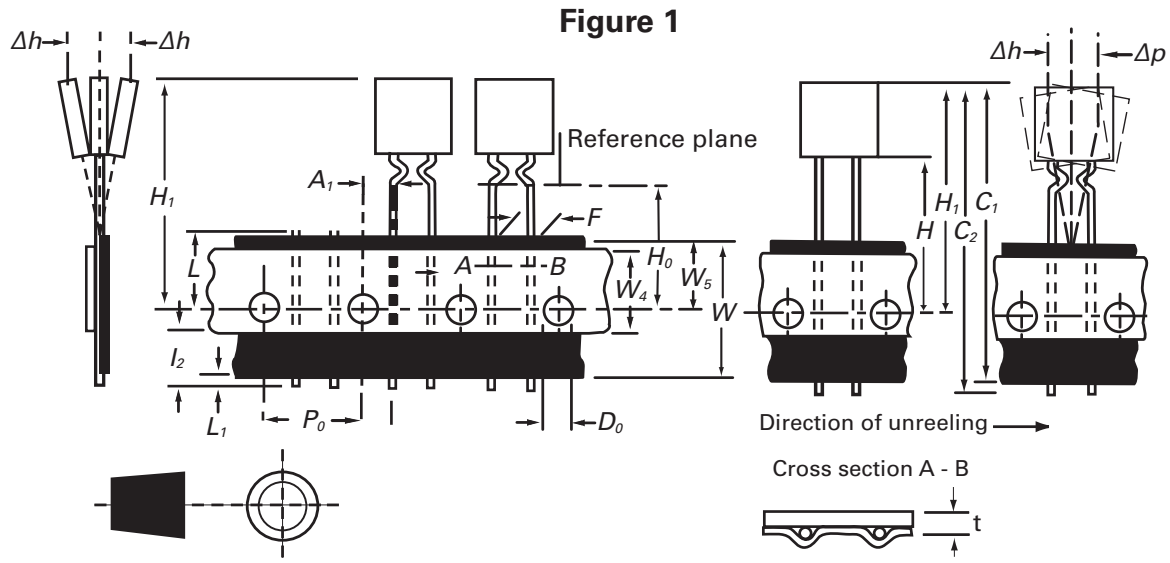

USBR Series

Part Ordering Number System

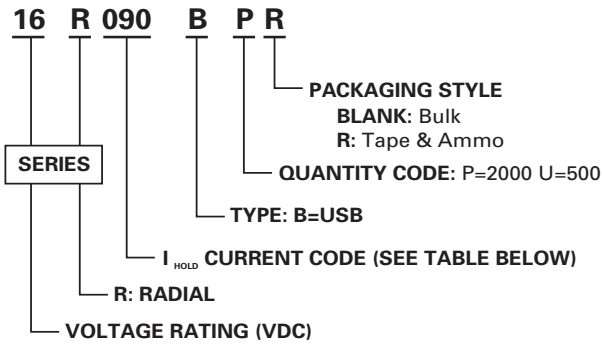

Ordering Information

Part Number	Ordering Number	I _{hold} (A)	I _{hold} Code	Packaging Option	Quantity	Quantity & Packaging Codes
06R075B	06R075BU	0.75	075	Bulk	500	U
	06R075BPR			Tape and Ammo	2000	PR
06R120B	06R120BU	1.20	120	Bulk	500	U
	06R120BPR			Tape and Ammo	2000	PR
06R155B	06R155BU	1.55	155	Bulk	500	U
	06R155BPR			Tape and Ammo	2000	PR
16R090B	16R090BU	0.90	090	Bulk	500	U
	16R090BPR			Tape and Ammo	2000	PR
16R110B	16R110BU	1.10	110	Bulk	500	U
	16R110BPR			Tape and Ammo	2000	PR
16R135B	16R135BU	1.35	135	Bulk	500	U
	16R135BPR			Tape and Ammo	2000	PR
16R160B	16R160BU	1.60	160	Bulk	500	U
	16R160BPR			Tape and Ammo	2000	PR
16R185B	16R185BU	1.85	185	Bulk	500	U
	16R185BPR			Tape and Ammo	2000	PR
16R250B	16R250BU	2.50	250	Bulk	500	U
	16R250BPR			Tape and Ammo	2000	PR

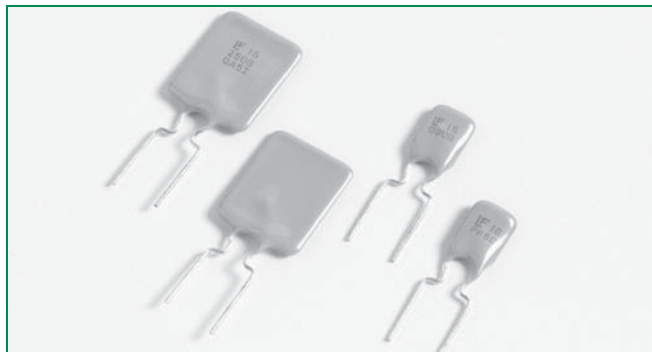
RoHS  16R Series

Description

The 16R Series Radial Leaded device is designed to provide different products in the general applications with maximum 16 volts and a maximum 100-ampere short circuit rating.



Features

- RoHS compliant
- Fast time-to-trip
- Meets all USB protection requirements
- 100A short circuit rating
- 16V Operating voltages



Applications

- Computers & peripherals
- Any USB application
- General Electronics

Agency Approvals

AGENCY	AGENCY FILE NUMBER
	E183209
	R50119318

Electrical Characteristics

Part Number	I _{hold} (A)	I _{trip} (A)	V _{max} (Vdc)	I _{max} (A)	P _d typ. (W)	Maximum Time To Trip		Resistance		Agency Approvals	
						Current (A)	Time (Sec.)	R _{min} (Ω)	R _{1max} (Ω)		
16R250G	2.5	4.7	16	100	1.0	12.5	5.0	0.0220	0.0530	X	X
16R300G	3.0	5.1	16	100	2.3	15.0	1.0	0.0380	0.0975	X	X
16R400G	4.0	6.8	16	100	2.4	20.0	1.7	0.0210	0.0600	X	X
16R500G	5.0	8.5	16	100	2.6	25.0	2.0	0.0150	0.0340	X	X
16R600G	6.0	10.2	16	100	2.8	30.0	3.3	0.0100	0.0280	X	X
16R700G	7.0	11.9	16	100	3.0	35.0	3.5	0.0077	0.0200	X	X
16R800G	8.0	13.6	16	100	3.0	40.0	5.0	0.0056	0.0175	X	X
16R900G	9.0	15.3	16	100	3.3	45.0	5.5	0.0047	0.0135	X	X
16R1000G	10.0	17.0	16	100	3.6	50.0	6.0	0.0040	0.0102	X	X
16R1100G	11.0	18.7	16	100	3.7	55.0	7.0	0.0037	0.0089	X	X
16R1200G	12.0	20.4	16	100	4.2	60.0	7.5	0.0033	0.0086	X	X
16R1400G	14.0	23.8	16	100	4.6	70.0	9.0	0.0026	0.0064	X	X

I_{hold} = Hold current: maximum current device will pass without tripping in 23°C still air.

I_{trip} = Trip current: minimum current at which the device will trip in 23°C still air.

V_{max} = Maximum voltage device can withstand without damage at rated current (I_{max})

I_{max} = Maximum fault current device can withstand without damage at rated voltage (V_{max})

P_d = Power dissipated from device when in the tripped state at 23°C still air.

R_{min} = Minimum resistance of device in initial (un-soldered) state.

R_{1max} = Maximum resistance of device at 23°C measured one hour after tripping.

Caution: Operation beyond the specified rating may result in damage and possible arcing and flame.

Temperature Derating

Part Number	Ambient Operation Temperature								
	-40°C	-20°C	0°C	23°C	40°C	50°C	60°C	70°C	85°C
16R250G	3.7	3.3	2.9	2.5	2.2	2.0	1.8	1.6	1.3
16R300G	4.4	4.0	3.5	3.0	2.6	2.4	2.1	1.9	1.6
16R400G	5.9	5.3	4.7	4.0	3.5	3.2	2.9	2.6	2.1
16R500G	7.4	6.6	5.9	5.0	4.4	4.0	3.6	3.2	2.6
16R600G	8.9	8.0	7.1	6.0	5.2	4.8	4.3	3.9	3.2
16R700G	10.4	9.3	8.2	7.0	6.1	5.6	5.0	4.5	3.7
16R800G	11.8	10.6	9.4	8.0	7.0	6.3	5.7	5.1	4.2
16R900G	13.3	12.0	10.6	9.0	7.8	7.1	6.5	5.8	4.7
16R1000G	14.8	13.3	11.8	10.0	8.7	7.9	7.1	6.4	5.3
16R1100G	16.3	14.6	12.9	11.0	9.6	8.7	7.9	7.0	5.8
16R1200G	17.7	15.9	14.1	12.0	10.5	9.5	8.6	7.7	6.3
16R1400G	20.7	18.6	16.5	14.0	12.2	11.1	10.0	9.0	7.4

Average Time Current Curves

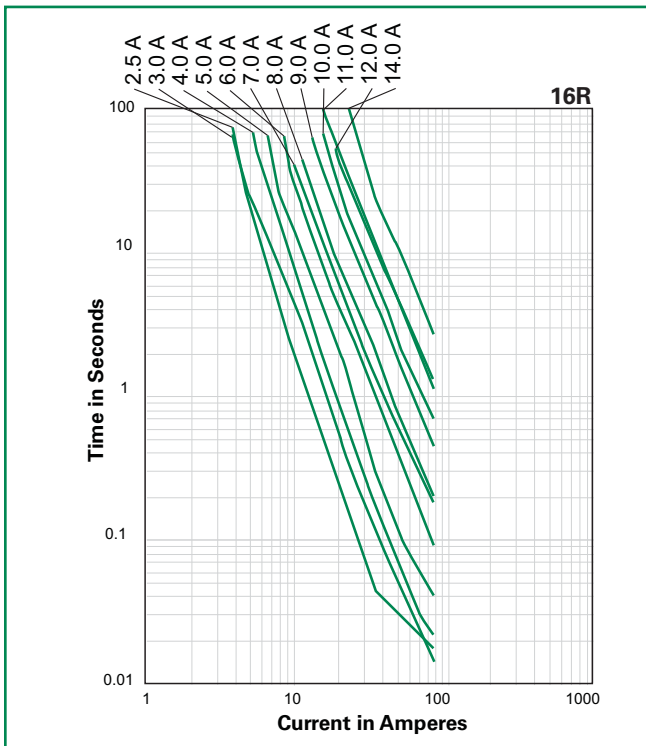

Temperature Derating Curve

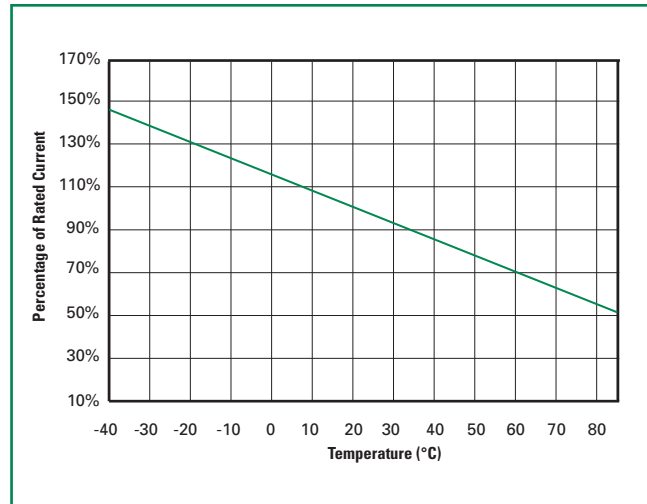

The average time current curves and Temperature Derating curve performance is affected by a number of variables, and these curves provided as guidance only. Customer must verify the performance in their application.

Soldering Parameters - Wave Soldering

Pre-Heating Zone	Refer to the condition recommended by the flux manufacturer. Max. ramping rate should not exceed 4°C/Sec.
Soldering Zone	Max. solder temperature should not exceed 260°C
Cooling Zone	Cooling by natural convection in air.

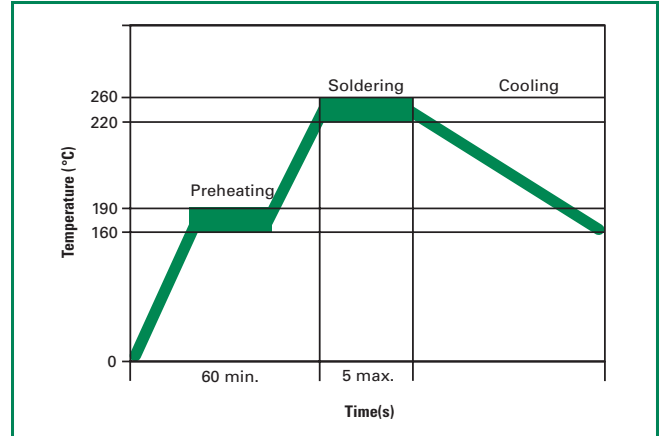

Physical Specifications

Lead Material	2.5A: Tin-plated Copper clad Steel 3.0 - 14.0A: Tin-plated Copper
Soldering Characteristics	Solderability per MIL-STD-202, Method 208E
Insulating Material	Cured, flame retardant epoxy polymer meets UL94V-0 requirements.
Device Labeling	Marked with 'LF', voltage, current rating, and date code.

Environmental Specifications

Operating/Storage Temperature	-40°C to +85°C
Maximum Device Surface Temperature in Tripped State	125°C
Passive Aging	+85°C, 1000 hours -/+ 5% typical resistance change
Humidity Aging	+85°C, 85% R.H., 1000 hours -/+ 5% typical resistance change
Thermal Shock	+85°C to -40°C 10 times -/+ 5% typical resistance change
Solvent Resistance	MIL-STD-202, Method 215F No change
Moisture Resistance Level	Level 2, J-STD-020C

Dimensions

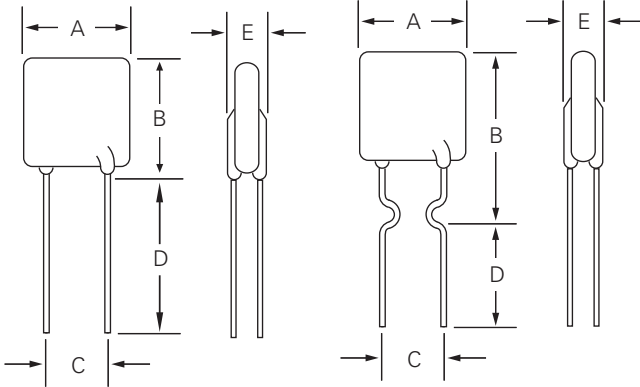
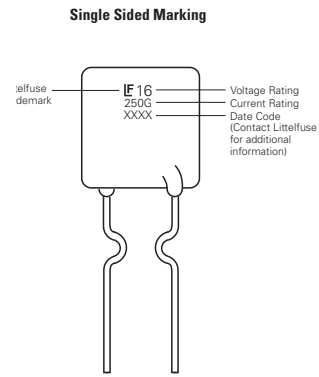

Figure 1

Figure 2

Part Marking System

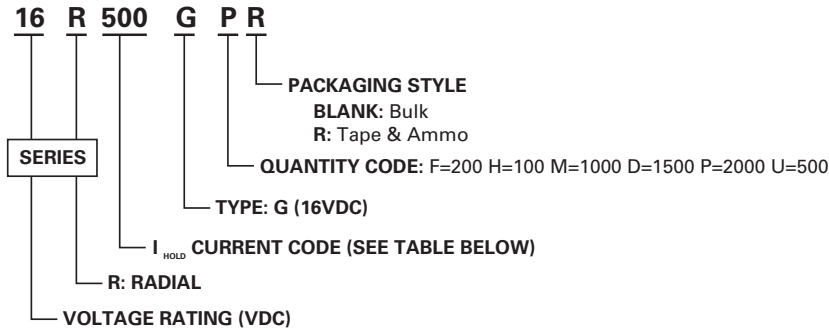

Part Number	Figure	A		B		C		D		E		Physical Characteristics		
		Inches	mm	Inches	mm	Inches	mm	Inches	mm	Inches	mm	Lead (dia)		Material
		Max.	Max.	Max.	Max.	Typ.	Typ.	Min.	Min.	Max.	Max.	Inches	mm	
16R250G	2	0.35	8.90	0.50	12.80	0.20	5.1	0.13	3.18	0.12	3.00	0.020	0.51	Sn/CuFe
16R300G	1	0.28	7.10	0.43	11.00	0.20	5.1	0.30	7.6	0.12	3.00	0.032	0.81	Sn/Cu
16R400G	1	0.35	8.90	0.50	12.80	0.20	5.1	0.30	7.6	0.12	3.00	0.032	0.81	Sn/Cu
16R500G	1	0.41	10.40	0.56	14.30	0.20	5.1	0.30	7.6	0.12	3.00	0.032	0.81	Sn/Cu
16R600G	1	0.42	10.70	0.67	17.10	0.20	5.1	0.30	7.6	0.12	3.00	0.032	0.81	Sn/Cu
16R700G	1	0.44	11.20	0.78	19.70	0.20	5.1	0.30	7.6	0.12	3.00	0.032	0.81	Sn/Cu
16R800G	1	0.50	12.70	0.82	20.90	0.20	5.1	0.30	7.6	0.12	3.00	0.032	0.81	Sn/Cu
16R900G	1	0.55	14.00	0.85	21.70	0.20	5.1	0.30	7.6	0.12	3.00	0.032	0.81	Sn/Cu
16R1000G	1	0.65	16.50	0.99	25.20	0.20	5.1	0.30	7.6	0.12	3.00	0.032	0.81	Sn/Cu
16R1100G	1	0.69	17.50	1.02	26.00	0.20	5.1	0.30	7.6	0.12	3.00	0.032	0.81	Sn/Cu
16R1200G	1	0.69	17.50	1.10	28.00	0.40	10.2	0.30	7.6	0.14	3.50	0.039	1.00	Sn/Cu
16R1400G	1	0.93	23.50	1.10	27.90	0.40	10.2	0.30	7.6	0.14	3.50	0.039	1.00	Sn/Cu

Part Ordering Number System

Packaging Options

Part Number	Ordering Number	I _{hold} (A)	I _{hold} Code	Packaging Option	Quantity	Quantity & Packaging Codes
16R250G	16R250GU	2.50	250	Bulk	500	U
	16R250GPR			Tape and Ammo	2000	PR
16R300G	16R300GU	3.00	300	Bulk	500	U
	16R300GPR			Tape and Ammo	2000	PR
16R400G	16R400GU	4.00	400	Bulk	500	U
	16R400GPR			Tape and Ammo	2000	PR
16R500G	16R500GU	5.00	500	Bulk	500	U
	16R500GPR			Tape and Ammo	2000	PR
16R600G	16R600GU	6.00	600	Bulk	500	U
	16R600GDR			Tape and Ammo	1500	DR
16R700G	16R700GF	7.00	700	Bulk	200	F
	16R700GMR			Tape and Ammo	1000	MR
16R800G	16R800GF	8.00	800	Bulk	200	F
	16R800GMR			Tape and Ammo	1000	MR
16R900G	16R900GF	9.00	900	Bulk	200	F
	16R900GMR			Tape and Ammo	1000	MR
16R1000G	16R1000GF	10.00	1000	Bulk	200	F
	16R1000GMR			Tape and Ammo	1000	MR
16R1100G	16R1100GF	11.00	1100	Bulk	200	F
	16R1100GMR			Tape and Ammo	1000	MR
16R1200G	16R1200GH	12.00	1200	Bulk	100	H
	16R1200GMR			Tape and Ammo	1000	MR
16R1400G	16R1400GH	14.00	1400	Bulk	100	H

Tape and Reel Specifications

Devices taped using EIA468-B/IE286-2 standards. See table below and Figures 1 and 2 for details.

Dimension	EIA Mark	IEC Mark	Dimensions	
			Dim. (mm)	Tol. (mm)
Carrier tape width	W	W	18	-0.5 /+1.0
Hold down tape width:	W₄	W₀	11	min.
Top distance between tape edges	W₆	W₂	3	max.
Sprocket hole position	W₅	W₁	9	-0.5 /+0.75
Sprocket hole diameter*	D₀	D₀	4	-0.32 /+0.2
Abscissa to plane(straight lead)	H	H	18.5	-/+ 3.0
Abscissa to plane(kinked lead)	H₀	H₀	16	-/+ 0.5
Abscissa to top			45.0	max.
Overall width w/o lead protrusion			56	max.
Overall width w/ lead protrusion			57	max.
Lead protrusion	L₁	I₁	1.0	max.
Protrusion of cut out	L	L	11	max.
Protrusion beyond hold-down tape	I₂	I₂	Not specified	
Sprocket hole pitch	P₀	P₀	25.4	-/+ 0.5
Device pitch:			25.4	
Pitch tolerance			20 consecutive.	-/+ 1
Tape thickness	t	t	0.9	max.
Tape thickness with splice	t₁		2.0	max.
Splice sprocket hole alignment			0	-/+ 0.3
Body lateral deviation	Δh	Δh	0	-/+ 1.0
Body tape plane deviation	Δp	Δp	0	-/+ 1.3
Ordinate to adjacent component lead*	P₁	P₁	3.81	-/+ 0.7
Ordinate to adjacent component lead*			7.62	-/+ 0.7
Lead spacing:16R250G-16R1100G	F	F	5.08	-/+ 0.8
Lead spacing:16R1200G-16R1400G	F	F	10.18	-/+ 0.8
Reel width	w₂	w	63.5	max.
Reel diameter	a	d	370	max.
Space between flanges less device*	w₁		4.75	-3.25 / +8.25
Arbor hole diameter	c	f	26	-/+ 12.0
Core diameter*	n	h	91	max.
Box			64/372/372	max.
Consecutive missing places			None	
Empty places per reel			0.1% max.	

*Differs from EIA specification

Tape and Reel Diagram

Figure 1

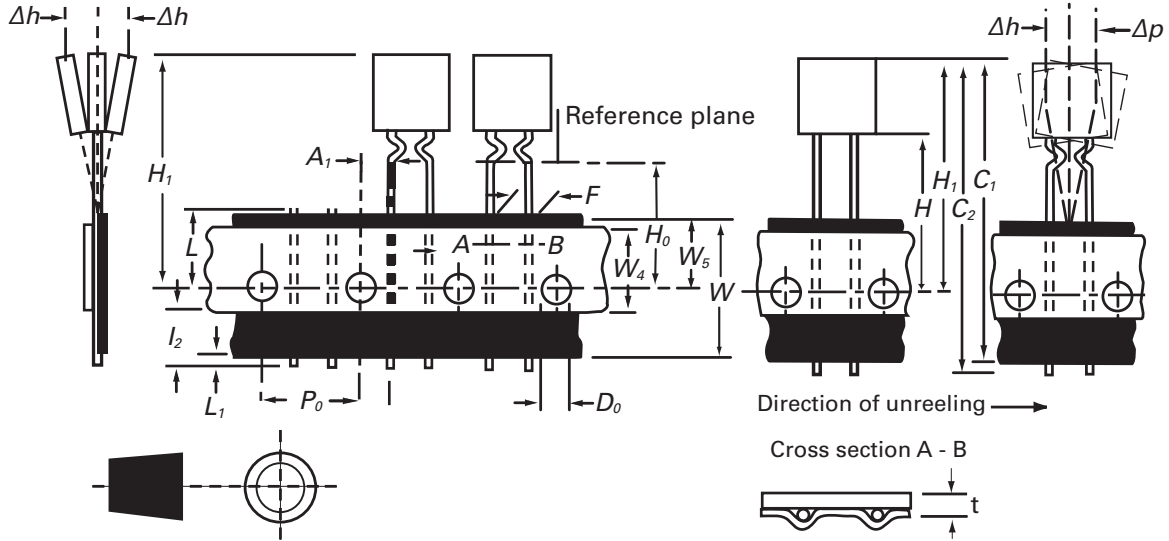
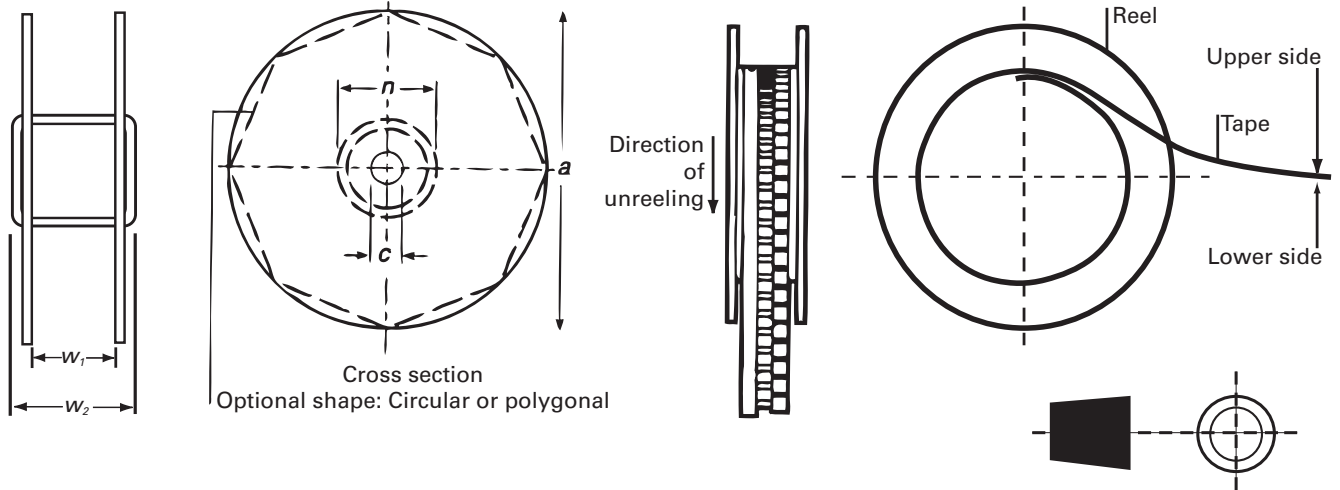
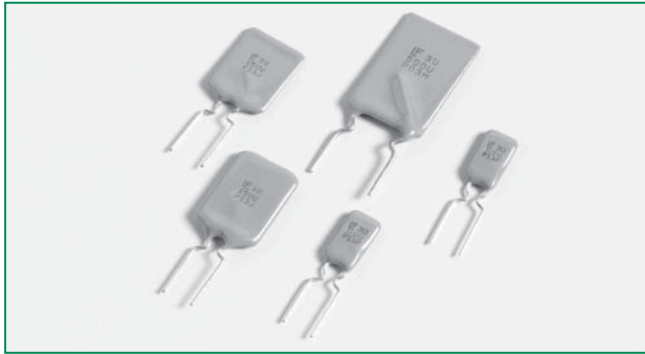

Figure 2



16R Series



Description

- The 30R Series radial leaded device is designed to provide overcurrent protection for low voltage ($\leq 30V$) applications where space is not a concern and resettable protection is preferred.

Features

- RoHS compliant and lead-free
- Fast time-to-trip
- Cured, flame retardant epoxy polymer insulating material meets UL 94V-0 requirements

Applications

- USB hubs, ports and peripherals
- Computers & peripherals
- Motor protection
- General electronics
- Automotive applications

Agency Approvals

AGENCY	AGENCY FILE NUMBER
	E183209
	R50119318

Electrical Characteristics

Part Number	I_{hold} (A)	I_{trip} (A)	V_{max} (Vdc)	I_{max} (A)	P_d max. (W)	Maximum Time To Trip		Resistance		Agency Approvals	
						Current (A)	Time (Sec.)	R_{min} (Ω)	R_{1max} (Ω)		
30R090	0.90	1.80	30	40	0.6	4.50	5.90	0.070	0.220	X	X
30R110	1.10	2.20	30	40	0.7	5.50	6.60	0.050	0.170	X	X
30R135	1.35	2.70	30	40	0.8	6.75	7.30	0.040	0.130	X	X
30R160	1.60	3.20	30	40	0.9	8.00	8.00	0.030	0.110	X	X
30R185	1.85	3.70	30	40	1.0	9.25	8.70	0.030	0.090	X	X
30R250	2.50	5.00	30	40	1.2	12.50	10.30	0.020	0.070	X	X
30R300	3.00	6.00	30	40	2.0	15.00	10.80	0.020	0.080	X	X
30R400	4.00	8.00	30	40	2.5	20.00	12.70	0.010	0.050	X	X
30R500	5.00	10.00	30	40	3.0	25.00	14.50	0.010	0.050	X	X
30R600	6.00	12.00	30	40	3.5	30.00	16.00	0.005	0.040	X	X
30R700	7.00	14.00	30	40	3.8	35.00	17.50	0.005	0.030	X	X
30R800	8.00	16.00	30	40	4.0	40.00	18.80	0.005	0.020	X	X
30R900	9.00	18.00	30	40	4.2	40.00	20.00	0.005	0.020	X	X

I_{hold} = Hold current: maximum current device will pass without tripping in 23°C still air.
 I_{trip} = Trip current: minimum current at which the device will trip in 23°C still air.
 V_{max} = Maximum voltage device can withstand without damage at rated current (I_{max})
 I_{max} = Maximum fault current device can withstand without damage at rated voltage (V_{max})
 P_d = Power dissipated from device when in the tripped state at 23°C still air.

R_{min} = Minimum resistance of device in initial (un-soldered) state.
 R_{1max} = Maximum resistance of device at 23°C measured one hour after tripping.
Caution: Operation beyond the specified rating may result in damage and possible arcing and flame.

Temperature Derating

Part Number	Ambient Operation Temperature								
	-40°C	-20°C	0°C	23°C	40°C	50°C	60°C	70°C	85°C
30R090	1.31	1.17	1.04	0.90	0.75	0.69	0.61	0.55	0.47
30R110	1.60	1.43	1.27	1.10	0.91	0.85	0.75	0.67	0.57
30R135	1.96	1.76	1.55	1.35	1.12	1.04	0.92	0.82	0.70
30R160	2.32	2.08	1.84	1.60	1.33	1.23	1.09	0.98	0.83
30R185	2.68	2.41	2.13	1.85	1.54	1.42	1.26	1.13	0.96
30R250	3.63	3.25	2.88	2.50	2.08	1.93	1.70	1.53	1.30
30R300	4.35	3.90	3.45	3.00	2.49	2.31	2.04	1.83	1.56
30R400	5.80	5.20	4.60	4.00	3.32	3.08	2.72	2.44	2.08
30R500	7.25	6.50	5.75	5.00	4.15	3.85	3.40	3.05	2.60
30R600	8.70	7.80	6.90	6.00	4.98	4.62	4.08	3.66	3.12
30R700	10.15	9.10	8.05	7.00	5.81	5.39	4.76	4.27	3.64
30R800	11.60	10.40	9.20	8.00	6.64	6.16	5.44	4.88	4.16
30R900	13.05	11.70	10.35	9.00	7.47	6.93	6.12	5.49	4.68

Average Time Current Curves

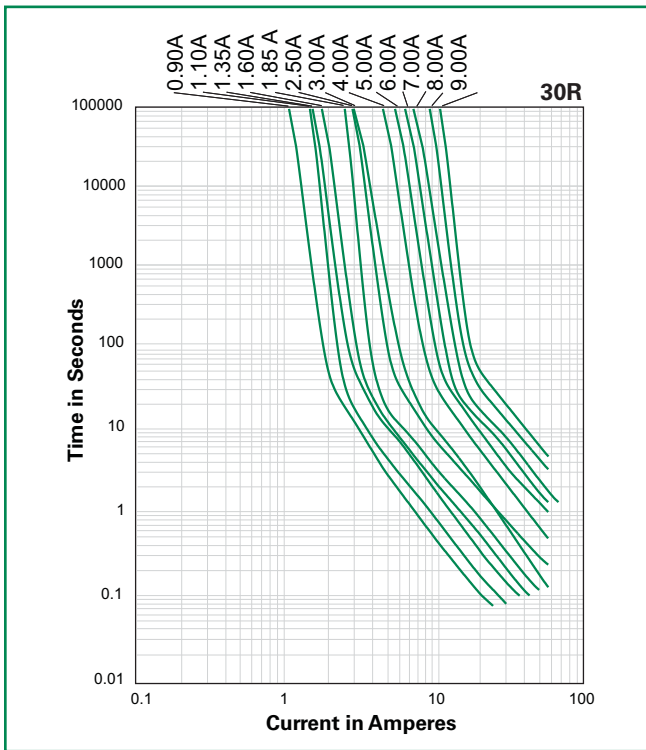

Temperature Derating Curve

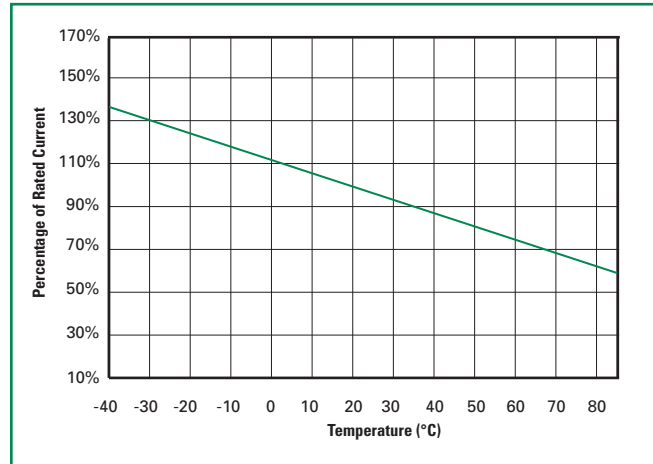

The average time current curves and Temperature Derating curve performance is affected by a number of variables, and these curves provided as guidance only. Customer must verify the performance in their application.

Soldering Parameters - Wave Soldering

Pre-Heating Zone	Refer to the condition recommended by the flux manufacturer. Max. ramping rate should not exceed 4°C/Sec.
Soldering Zone	Max. solder temperature should not exceed 260°C
Cooling Zone	Cooling by natural convection in air.

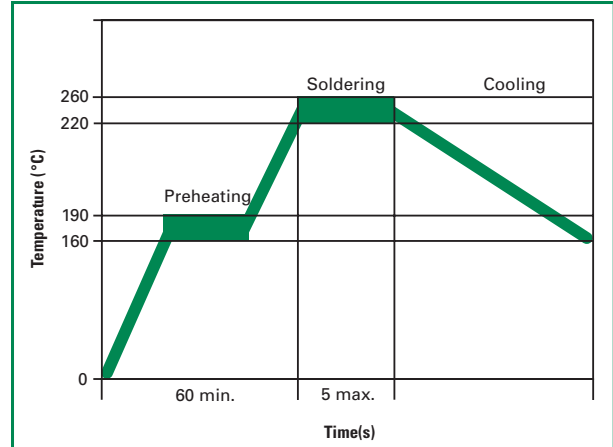

Physical Specifications

Lead Material	0.90-2.50A: Tin-plated Copper clad steel 3.00-9.00A: Tin-plated Copper
Soldering Characteristics	Solderability per MIL-STD-202, Method 208E
Insulating Material	Cured, flame retardant epoxy polymer meets UL94V-0 requirements.
Device Labeling	Marked with 'LF', voltage, current rating, and date code.

Environmental Specifications

Operating/Storage Temperature	-40°C to +85°C
Maximum Device Surface Temperature in Tripped State	125°C
Passive Aging	+85°C, 1000 hours -/+5% typical resistance change
Humidity Aging	+85°C, 85% R.H., 1000 hours -/+5% typical resistance change
Thermal Shock	+85°C to -40°C 10 times -/+5% typical resistance change
Solvent Resistance	MIL-STD-202, Method 215F No change
Moisture Resistance Level	Level 2, J-STD-020C

Dimensions

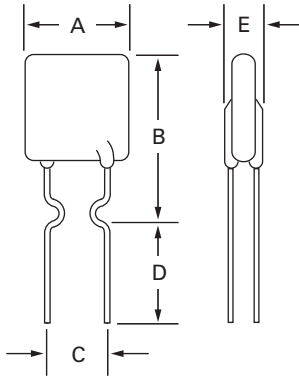

Part Marking System

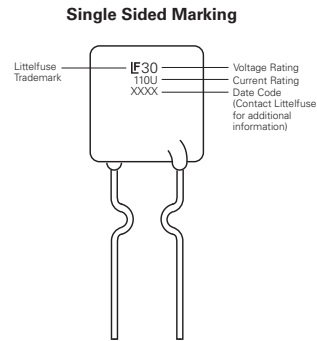

Part Number	A		B		C		D		E		Physical Characteristics		
	Inches	mm	Inches	mm	Inches	mm	Inches	mm	Inches	mm	Lead (dia)		Material
	Max.	Max.	Max.	Max.	Typ.	Typ.	Min.	Min.	Max.	Max.	Inches	mm	
30R090	0.29	7.40	0.48	12.20	0.20	5.10	0.30	7.60	0.12	3.00	0.02	0.51	Sn/CuFe
30R110	0.29	7.40	0.56	14.20	0.20	5.10	0.30	7.60	0.12	3.00	0.02	0.51	Sn/CuFe
30R135	0.35	8.90	0.53	13.50	0.20	5.10	0.30	7.60	0.12	3.00	0.02	0.51	Sn/CuFe
30R160	0.35	8.90	0.60	15.20	0.20	5.10	0.30	7.60	0.12	3.00	0.02	0.51	Sn/CuFe
30R185	0.40	10.20	0.62	15.70	0.20	5.10	0.30	7.60	0.12	3.00	0.02	0.51	Sn/CuFe
30R250	0.45	11.40	0.72	18.30	0.20	5.10	0.30	7.60	0.12	3.00	0.02	0.51	Sn/Cu
30R300	0.45	11.40	0.76	19.20	0.20	5.10	0.30	7.60	0.12	3.00	0.03	0.81	Sn/Cu
30R400	0.55	14.00	0.87	22.00	0.20	5.10	0.30	7.60	0.12	3.00	0.03	0.81	Sn/Cu
30R500	0.55	14.00	1.01	25.60	0.40	10.20	0.30	7.60	0.12	3.00	0.03	0.81	Sn/Cu
30R600	0.65	16.50	1.06	26.80	0.40	10.20	0.30	7.60	0.12	3.00	0.03	0.81	Sn/Cu
30R700	0.75	19.10	1.13	28.60	0.40	10.20	0.30	7.60	0.12	3.00	0.03	0.81	Sn/Cu
30R800	0.85	21.60	1.22	31.10	0.40	10.20	0.30	7.60	0.12	3.00	0.03	0.81	Sn/Cu
30R900	0.95	24.10	1.24	31.60	0.40	10.20	0.30	7.60	0.12	3.00	0.03	0.81	Sn/Cu

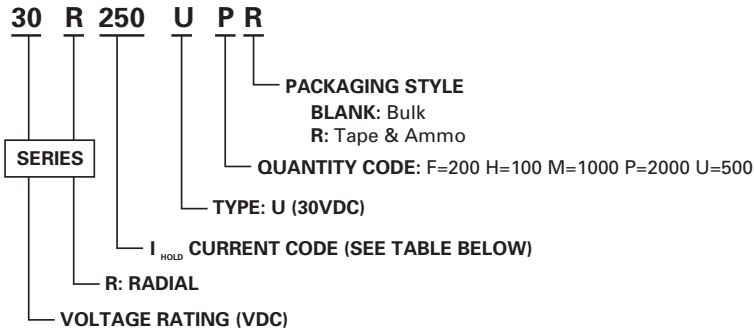
Part Ordering Number System

Packaging

Part Number	Ordering Number	I_{hold} (A)	I_{hold} Code	Packaging Option	Quantity	Quantity & Packaging Codes
30R090	30R090UU	0.90	090	Bulk	500	U
	30R090UPR			Tape and Ammo	2000	PR
30R110	30R110UU	1.10	110	Bulk	500	U
	30R110UPR			Tape and Ammo	2000	PR
30R135	30R135UU	1.35	135	Bulk	500	U
	30R135UPR			Tape and Ammo	2000	PR
30R160	30R160UU	1.60	160	Bulk	500	U
	30R160UPR			Tape and Ammo	2000	PR
30R185	30R185UU	1.85	185	Bulk	500	U
	30R185UPR			Tape and Ammo	2000	PR
30R250	30R250UU	2.50	250	Bulk	500	U
	30R250UPR			Tape and Ammo	2000	PR
30R300	30R300UU	3.00	300	Bulk	500	U
	30R300UPR			Tape and Ammo	2000	PR
30R400	30R400UF	4.00	400	Bulk	200	F
	30R400UMR			Tape and Ammo	1000	MR
30R500	30R500UF	5.00	500	Bulk	200	F
	30R500UMR			Tape and Ammo	1000	MR
30R600	30R600UF	6.00	600	Bulk	200	F
	30R600UMR			Tape and Ammo	1000	MR
30R700	30R700UF	7.00	700	Bulk	200	F
	30R700UMR			Tape and Ammo	1000	MR
30R800	30R800UH	8.00	800	Bulk	100	H
30R900	30R900UH	9.00	900	Bulk	100	H

Tape and Reel Specifications

Devices taped using EIA468-B/E286-2 standards. See table below and Figures 1 and 2 for details.

Dimension	EIA Mark	IEC Mark	Dimensions	
			Dim. (mm)	Tol. (mm)
Carrier tape width	W	W	18	-0.5 / +1.0
Hold down tape width:	W₄	W₀	11	min.
Top distance between tape edges	W₆	W₂	3	max.
Sprocket hole position	W₅	W₁	9	-0.5 / +0.75
Sprocket hole diameter*	D₀	D₀	4	-0.32 / +0.2
Abscissa to plane(straight lead)	H	H	18.5	-/+ 3.0
Abscissa to plane(kinked lead)	H₀	H₀	16	-/+ 0.5
Abscissa to top: 30R090-30R185	H₁	H₁	32.2	max.
Abscissa to top: 30R250-30R900			45.0	max.
Overall width w/o lead protrusion: 30R090-30R185	C₁		42.5	max.
Overall width w/o lead protrusion: 30R250-30R900			56	max.
Overall width w/ lead protrusion: 30R090-30R185	C₂		43.2	max.
Overall width w/ lead protrusion: 30R250-30R900			57	max.
Lead protrusion	L₁	L₁	1.0	max.
Protrusion of cut out	L	L	11	max.
Protrusion beyond hold-down tape	L₂	L₂	Not specified	
Sprocket hole pitch: 30R090-30R300	P₀	P₀	12.7	-/+ 0.3
Sprocket hole pitch on: 30R400-30R900	P₀	P₀	25.4	-/+ 0.5
Device pitch: 30R090-30R300			12.7	
Device pitch: 30R400-30R900			25.4	
Pitch tolerance			20 consecutive.	-/+ 1
Tape thickness	t	t	0.9	max.
Tape thickness with splice: 30R090-30R250	t₁		1.5	max.
Tape thickness with splice: 30R300-30R900	t₁		2.0	max.
Splice sprocket hole alignment			0	-/+ 0.3
Body lateral deviation	Δh	Δh	0	-/+ 1.0
Body tape plane deviation	Δp	Δp	0	-/+ 1.3
Ordinate to adjacent component lead*	P₁	P₁	3.81	-/+ 0.7
Ordinate to adjacent component lead*			7.62	-/+ 0.7
Lead spacing: 30R090-30R400	F	F	5.08	-/+ 0.8
Lead spacing: 30R500-30R900	F	F	10.18	-/+ 0.8
Reel width: 30R090-30R185	w₂	w	56	max.
Reel width: 30R250-30R900	w₂	w	63.5	max.
Reel diameter	a	d	370	max.
Space between flanges less device*	w₁		4.75	-3.25 / +8.25
Arbor hole diameter	c	f	26	-/+ 12.0
Core diameter*	n	h	91	max.
Box			64/372/372	max.
Consecutive missing places			None	
Empty places per reel			0.1% max.	

*Differs from EIA Specification

Tape and Reel Diagram

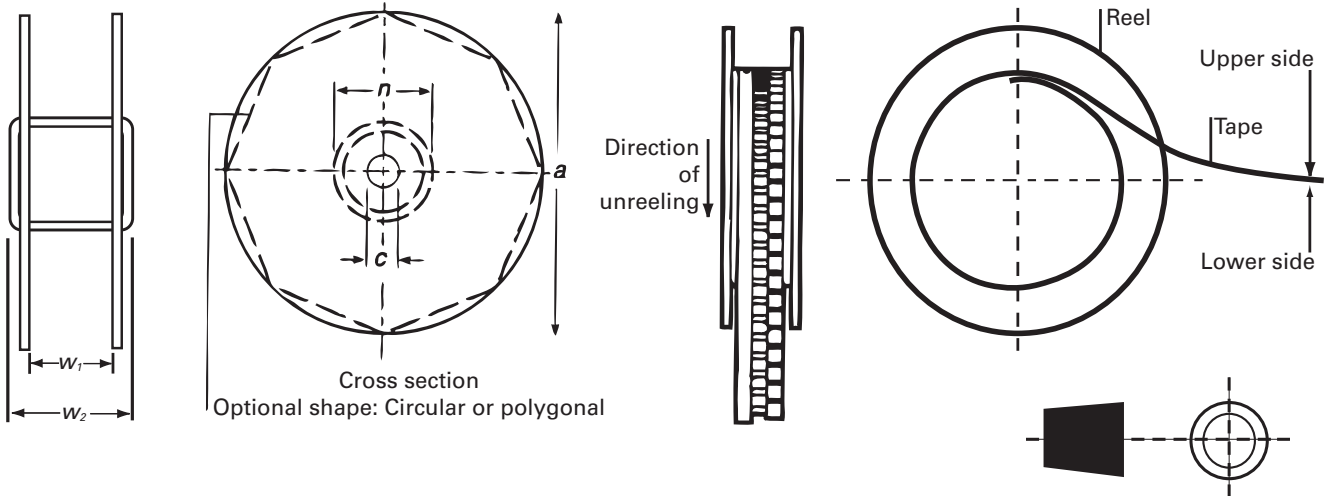
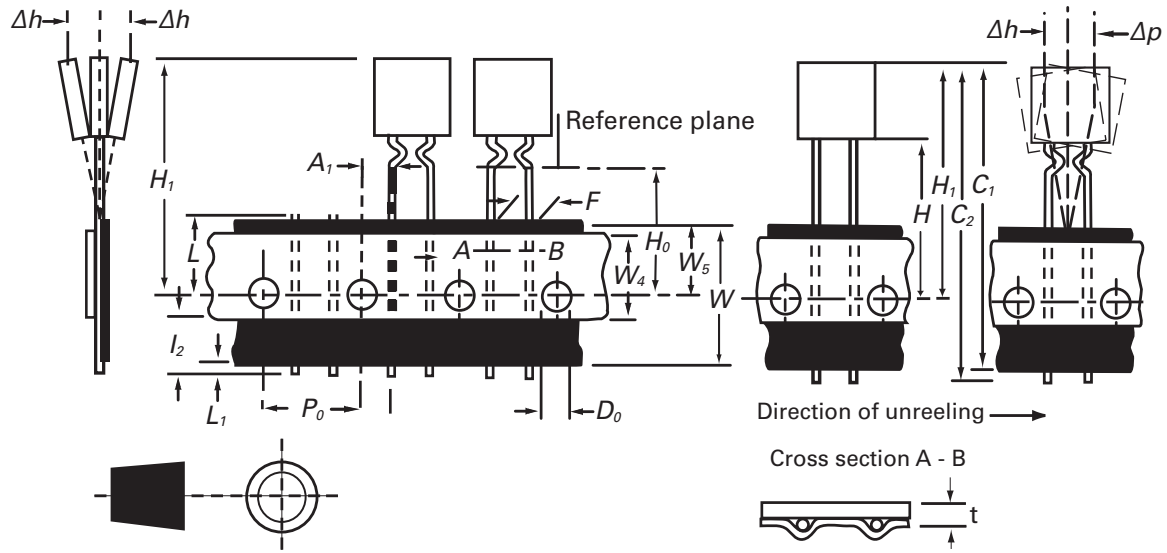

30R Series





Description

The 60R Series radial leaded device is designed to provide overcurrent protection for ($\leq 60V$) applications where space is not a concern and resettable protection is preferred.

Features

- RoHS compliant and lead-free
- Fast time-to-trip
- Cured, flame retardant epoxy polymer insulating material meets UL 94V-0 requirements



Agency Approvals

AGENCY	AGENCY FILE NUMBER
	E183209
	R50119318

Applications

- USB hubs, ports and peripherals
- IEEE1394 ports
- Computers & peripherals
- Motor protection
- General electronics
- Automotive applications
- Industrial controls
- Transformers

Electrical Characteristics

Part Number	I_{hold} (A)	I_{trip} (A)	V_{max} (Vdc)	I_{max} (A)	P_d max. (W)	Maximum Time To Trip		Resistance		Agency Approvals	
						Current (A)	Time (Sec.)	R_{min} (Ω)	R_{1max} (Ω)		
60R010	0.10	0.20	60	40	0.38	0.50	4.00	2.500	7.500	X	X
60R020	0.20	0.40	60	40	0.41	1.00	2.20	1.830	4.400	X	X
60R025	0.25	0.50	60	40	0.45	1.25	2.50	1.250	3.000	X	X
60R030	0.30	0.60	60	40	0.49	1.50	3.00	0.880	2.100	X	X
60R040	0.40	0.80	60	40	0.56	2.00	3.80	0.550	1.290	X	X
60R050	0.50	1.00	60	40	0.77	2.50	4.00	0.500	1.170	X	X
60R065	0.65	1.30	60	40	0.88	3.25	5.30	0.310	0.720	X	X
60R075	0.75	1.50	60	40	0.92	3.75	6.30	0.250	0.600	X	X
60R090	0.90	1.80	60	40	0.99	4.50	7.20	0.200	0.470	X	X
60R110	1.10	2.20	60	40	1.50	5.50	8.20	0.150	0.380	X	X
60R135	1.35	2.70	60	40	1.70	6.75	9.60	0.120	0.300	X	X
60R160	1.60	3.20	60	40	1.90	8.00	11.40	0.090	0.220	X	X
60R185	1.85	3.70	60	40	2.10	9.25	12.60	0.080	0.190	X	X
60R250	2.50	5.00	60	40	2.50	12.50	15.60	0.050	0.130	X	X
60R300	3.00	6.00	60	40	2.80	15.00	19.80	0.040	0.100	X	X
60R375	3.75	7.50	60	40	3.20	18.75	24.00	0.030	0.080	X	X

I_{hold} = Hold current: maximum current device will pass without tripping in 20°C still air.
 I_{trip} = Trip current: minimum current at which the device will trip in 20°C still air.
 V_{max} = Maximum voltage device can withstand without damage at rated current (I_{max})
 I_{max} = Maximum fault current device can withstand without damage at rated voltage (V_{max})
 P_d = Power dissipated from device when in the tripped state at 20°C still air.

R_{min} = Minimum resistance of device in initial (un-soldered) state.
 R_{typ} = Typical resistance of device in initial (un-soldered) state.
 R_{1max} = Maximum resistance of device at 20°C measured one hour after tripping or reflow soldering of 260°C for 20 sec.

Caution: Operation beyond the specified rating may result in damage and possible arcing and flame.

Temperature Derating

Part Number	Ambient Operation Temperature								
	-40°C	-20°C	0°C	23°C	40°C	50°C	60°C	70°C	85°C
	Hold Current (A)								
60R010	0.16	0.14	0.12	0.10	0.08	0.07	0.06	0.05	0.04
60R020	0.31	0.27	0.24	0.20	0.16	0.14	0.13	0.11	0.08
60R025	0.39	0.34	0.30	0.25	0.20	0.18	0.16	0.14	0.10
60R030	0.47	0.41	0.36	0.30	0.24	0.22	0.19	0.16	0.12
60R040	0.62	0.54	0.48	0.40	0.32	0.29	0.25	0.22	0.16
60R050	0.78	0.68	0.60	0.50	0.41	0.36	0.32	0.27	0.20
60R065	1.01	0.88	0.77	0.65	0.53	0.47	0.41	0.35	0.26
60R075	1.16	1.02	0.89	0.75	0.61	0.54	0.47	0.41	0.30
60R090	1.40	1.22	1.07	0.90	0.73	0.65	0.57	0.49	0.36
60R110	1.71	1.50	1.31	1.10	0.89	0.79	0.69	0.59	0.44
60R135	2.09	1.84	1.61	1.35	1.09	0.97	0.85	0.73	0.54
60R160	2.48	2.18	1.90	1.60	1.30	1.15	1.01	0.86	0.64
60R185	2.87	2.52	2.20	1.85	1.50	1.33	1.17	1.00	0.74
60R250	3.88	3.40	2.98	2.50	2.03	1.80	1.58	1.35	1.00
60R300	4.65	4.08	3.57	3.00	2.43	2.16	1.89	1.62	1.20
60R375	5.81	5.10	4.46	3.75	3.04	2.70	2.36	2.03	1.50

Average Time Current Curves

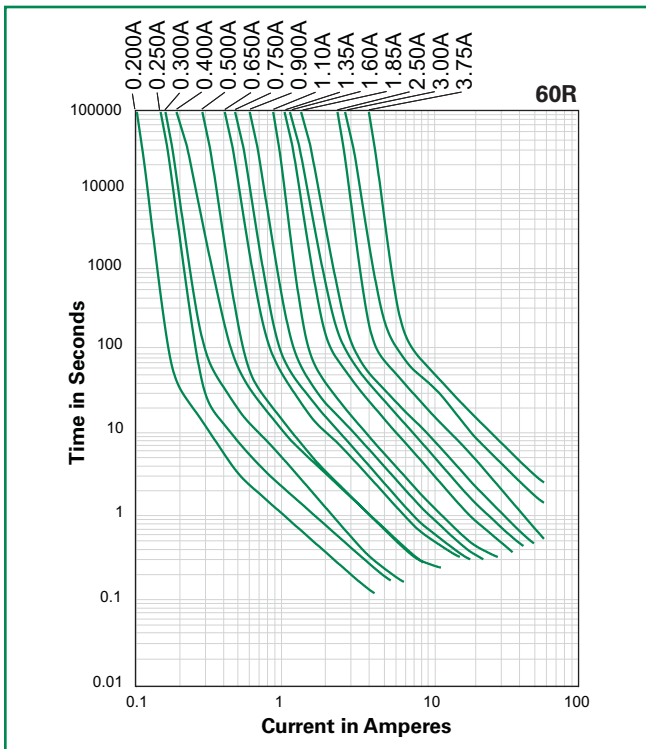

Temperature Derating Curve

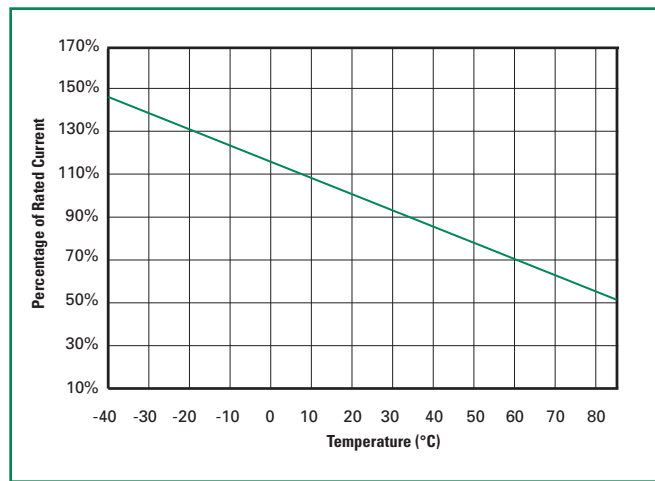

The average time current curves and Temperature Derating curve performance is affected by a number of variables, and these curves provided as guidance only. Customer must verify the performance in their application.

Soldering Parameters - Wave Soldering

Pre-Heating Zone	Refer to the condition recommended by the flux manufacturer. Max. ramping rate should not exceed 4°C/Sec.
Soldering Zone	Max. solder temperature should not exceed 260°C
Cooling Zone	Cooling by natural convection in air.

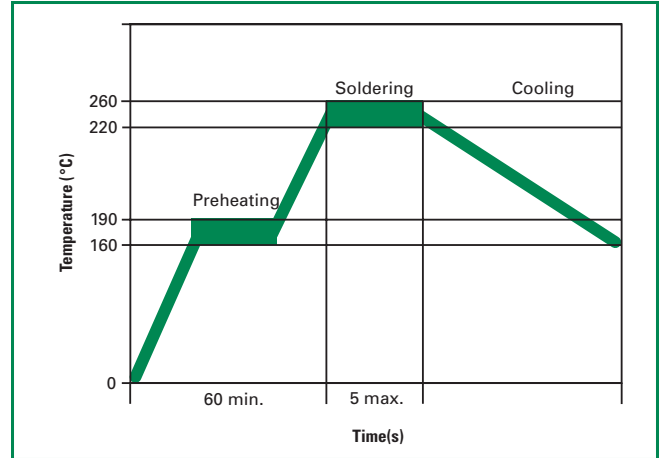

Physical Specifications

Lead Material	.20-.40A: Tin-plated Copper clad steel .50-3.75A: Tin-plated Copper
Soldering Characteristics	Solderability per MIL-STD-202, Method 208E
Insulating Material	Cured, flame retardant epoxy polymer meets UL94V-0 requirements.
Device Labeling	Marked with 'LF', voltage, current rating, and date code.

Environmental Specifications

Operating/Storage Temperature	-40°C to +85°C
Maximum Device Surface Temperature in Tripped State	125°C
Passive Aging	+85°C, 1000 hours +/− 5% typical resistance change
Humidity Aging	+85°C, 85% R.H., 1000 hours +/− 5% typical resistance change
Thermal Shock	+85°C to -40°C 10 times +/− 5% typical resistance change
Solvent Resistance	MIL-STD-202, Method 215F
Moisture Resistance Level	Level 2, J-STD-020C

Dimensions

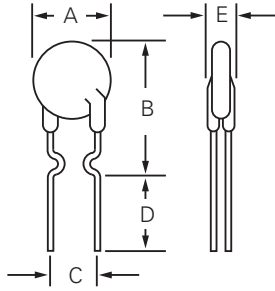

Part Marking System

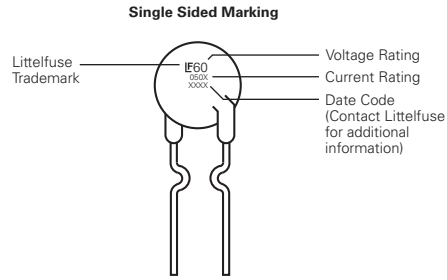

Part Number	A		B		C		D		E		Physical Characteristics		
	Inches	mm	Inches	mm	Inches	mm	Inches	mm	Inches	mm	Lead (dia)		Material
	Max.	Max.	Max.	Max.	Typ.	Typ.	Min.	Min.	Max.	Max.	Inches	mm	
60R010	0.29	7.4	0.50	12.7	0.20	5.1	0.30	7.6	0.12	3.1	0.02	0.51	Sn/CuFe
60R020	0.29	7.4	0.46	11.7	0.20	5.1	0.30	7.6	0.12	3.1	0.02	0.51	Sn/CuFe
60R025	0.29	7.4	0.50	12.7	0.20	5.1	0.30	7.6	0.12	3.1	0.02	0.51	Sn/CuFe
60R030	0.29	7.4	0.50	12.7	0.20	5.1	0.30	7.6	0.12	3.1	0.02	0.51	Sn/CuFe
60R040	0.30	7.6	0.53	13.5	0.20	5.1	0.30	7.6	0.12	3.1	0.02	0.51	Sn/CuFe
60R050	0.31	7.9	0.54	13.7	0.20	5.1	0.30	7.6	0.12	3.1	0.02	0.51	Sn/Cu
60R065	0.37	9.4	0.57	14.5	0.20	5.1	0.30	7.6	0.12	3.1	0.02	0.51	Sn/Cu
60R075	0.40	10.2	0.59	15	0.20	5.1	0.30	7.6	0.12	3.1	0.02	0.51	Sn/Cu
60R090	0.44	11.2	0.62	15.8	0.20	5.1	0.30	7.6	0.12	3.1	0.02	0.51	Sn/Cu
60R110	0.51	13	0.72	18.2	0.20	5.1	0.30	7.6	0.12	3.1	0.03	0.81	Sn/Cu
60R135	0.53	13.58	0.78	19.8	0.20	5.1	0.30	7.6	0.12	3.1	0.03	0.81	Sn/Cu
60R160	0.60	15.36	0.85	21.6	0.20	5.1	0.30	7.6	0.12	3.1	0.03	0.81	Sn/Cu
60R185	0.66	16.76	0.91	23	0.20	5.1	0.30	7.6	0.12	3.1	0.03	0.81	Sn/Cu
60R250	0.78	19.93	1.03	26.2	0.40	10.2	0.30	7.6	0.12	3.1	0.03	0.81	Sn/Cu
60R300	0.91	23.11	1.15	29.3	0.40	10.2	0.30	7.6	0.12	3.1	0.03	0.81	Sn/Cu
60R375	1.04	26.3	1.22	31.1	0.40	10.2	0.30	7.6	0.12	3.1	0.03	0.81	Sn/Cu

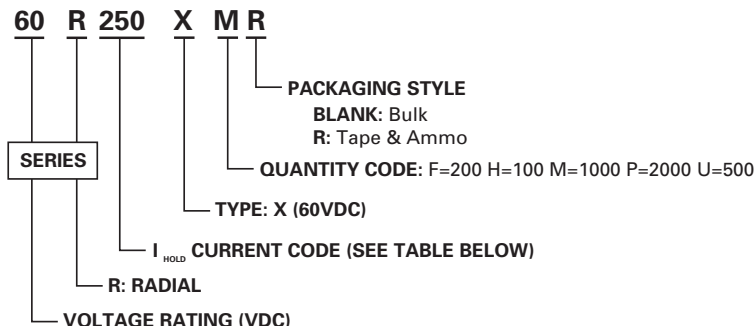
Part Ordering Number System

Packaging

Part Number	Ordering Number	I_{hold} (A)	I_{hold} Code	Packaging Option	Quantity	Quantity & Packaging Codes
60R010	60R010XU	0.10	010	Bulk	500	U
	60R010XPR			Tape and Ammo	2000	PR
60R020	60R020XU	0.20	020	Bulk	500	U
	60R020XPR			Tape and Ammo	2000	PR
60R025	60R025XU	0.25	025	Bulk	500	U
	60R025XPR			Tape and Ammo	2000	PR
60R030	60R030XU	0.30	030	Bulk	500	U
	60R030XPR			Tape and Ammo	2000	PR
60R040	60R040XU	0.40	040	Bulk	500	U
	60R040XPR			Tape and Ammo	2000	PR
60R050	60R050XU	0.50	050	Bulk	500	U
	60R050XPR			Tape and Ammo	2000	PR
60R065	60R065XU	0.65	065	Bulk	500	U
	60R065XPR			Tape and Ammo	2000	PR
60R075	60R075XU	0.75	075	Bulk	500	U
	60R075XPR			Tape and Ammo	2000	PR
60R090	60R090XU	0.90	090	Bulk	500	U
	60R090XPR			Tape and Ammo	2000	PR
60R110	60R110XU	1.10	110	Bulk	500	U
	60R110XMR			Tape and Ammo	1000	MR
60R135	60R135XF	1.35	135	Bulk	200	F
	60R135XMR			Tape and Ammo	1000	MR
60R160	60R160XF	1.60	160	Bulk	200	F
	60R160XMR			Tape and Ammo	1000	MR
60R185	60R185XF	1.85	185	Bulk	200	F
	60R185XMR			Tape and Ammo	1000	MR
60R250	60R250XF	2.50	250	Bulk	200	F
	60R250XMR			Tape and Ammo	1000	MR
60R300	60R300XF	3.00	300	Bulk	200	F
60R375	60R375XH	3.75	375	Bulk	100	H

Tape and Reel Specifications

Devices taped using EIA468-B/E286-2 standards. See table below and Figures 1 and 2 for details.

Dimension	EIA Mark	IEC Mark	Dimensions	
			Dim. (mm)	Tol. (mm)
Carrier tape width	W	W	18	-0.5 / +1.0
Hold down tape width	W₄	W₀	11	min.
Top distance between tape edges	W₆	W₂	3	max.
Sprocket hole position	W₅	W₁	9	-0.5 / +0.75
Sprocket hole diameter*	D₀	D₀	4	-0.32 / +0.2
Abscissa to plane(straight lead)	H	H	18.5	-/+ 3.0
Abscissa to plane(kinked lead)	H₀	H₀	16	-/+ 0.5
Abscissa to top 60R010-60R090	H₁	H₁	32.2	max.
Abscissa to top 60R110-60R300	H₁		47.5	max.
Overall width without lead protrusion:60R010-60R090	C₁		42.5	max.
Overall width without lead protrusion:60R110-60R300			57	
Overall width with lead protrusion:60R010-60R090	C2		43.2	max.
Overall width with lead protrusion:60R110-60R300			58	
Lead protrusion	L₁	I₁	1.0	max.
Protrusion of cut out	L	L	11	max.
Protrusion beyond hold-down tape	I₂	I₂	Not specified	
Sprocket hole pitch:60R010-60R090	P₀	P₀	12.7	-/+ 0.3
Sprocket hole pitch:60R110-60R300	P₀	P₀	25.4	-/+ 0.5
Pitch tolerance			20 consecutive.	-/+ 1
Device pitch:60R010-60R090			12.7	
Device pitch:60R110-60R300			25.4	
Tape thickness	t	t	0.9	max.
Tape thickness with splice	t₁		2.0	max.
Splice sprocket hole alignment			0	-/+ 0.3
Body lateral deviation	Δh	Δh	0	-/+ 1.0
Body tape plane deviation	Δp	Δp	0	-/+ 1.3
Ordinate to adjacent component lead*:60R010-60R090	P₁	P₁	3.81	-/+ 0.7
Ordinate to adjacent component lead*:60R110-60R300			7.62	-/+ 0.7
Lead spacing:60R010-60R185	F	F	5.08	-/+ 0.8
Lead spacing:60R250-60R300	F	F	10.18	-/+ 0.8
Reel width: 60R010-60R065	w₂	w	56	max.
Reel width: 60R075-60R300	w₂	w	63.5	max.
Reel diameter	a	d	370	max.
Space between flanges less device*	w₁		4.75	-3.25 / +9.25
Arbor hole diameter	c	f	26	-/+ 12.0
Core diameter*	n	h	91	max.
Box			56/372/372	max.
Consecutive missing places			None	
Empty places per reel			0.1% max.	

*Differs from EIA Specification

Tape and Reel Diagram

Figure 1

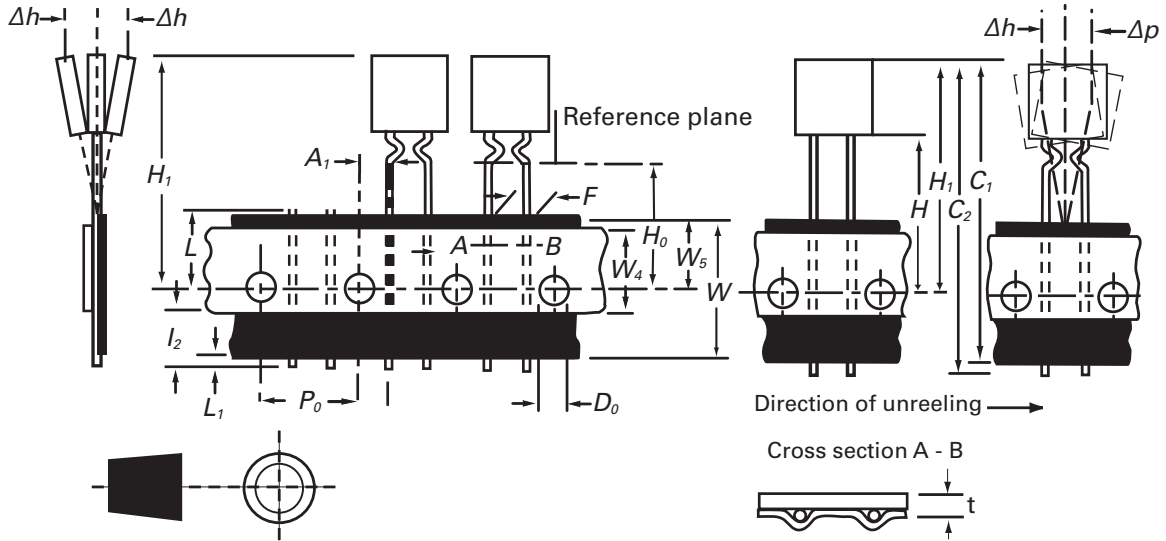
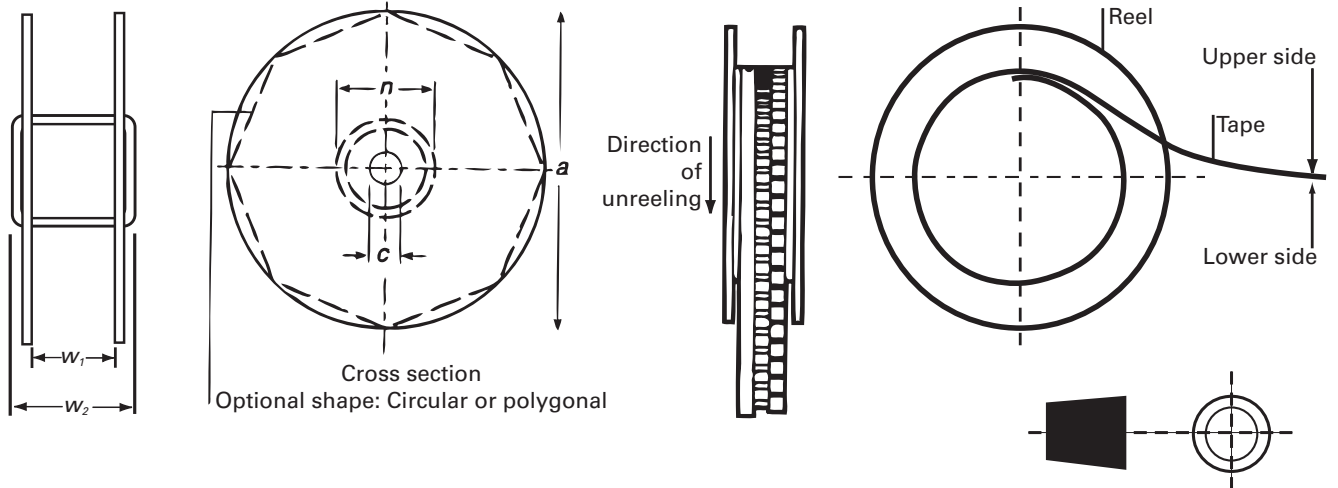

Figure 2



60R Series



Description

The 72R Series is designed to provide overcurrent protection to 72Vdc maximum voltage with a maximum 40A short circuit rating.



Features

- RoHS Compliant and lead-free
- 72Vdc max voltage w/max 40A short circuit rating
- Resettable feature
- Ideal for a broad range of general electronics using a low voltage power supply



Applications

- Load protection on wide range of low voltage power supplies
- Computers
- Computer peripherals
- General electronics

Agency Approvals

AGENCY	AGENCY FILE NUMBER
	E183209
	R50119318

Electrical Characteristics

Part Number	I _{hold} (A)	I _{trip} (A)	V _{max} (Vdc)	I _{max} (A)	P _d typ. (W)	Maximum Time To Trip		Resistance		Agency Approvals	
						Current (A)	Time (Sec.)	R _{min} (Ω)	R _{1max} (Ω)		
72R020X	0.20	0.40	72	40	0.41	1.00	2.20	1.830	4.400	X	X
72R025X	0.25	0.50	72	40	0.45	1.25	2.50	1.250	3.000	X	X
72R030X	0.30	0.60	72	40	0.49	1.50	3.00	0.880	2.100	X	X
72R040X	0.40	0.80	72	40	0.56	2.00	3.80	0.550	1.290	X	X
72R050X	0.50	1.00	72	40	0.77	2.50	4.00	0.500	1.170	X	X
72R065X	0.65	1.30	72	40	0.88	3.25	5.30	0.310	0.720	X	X
72R075X	0.75	1.50	72	40	0.92	3.75	6.30	0.250	0.600	X	X
72R090X	0.90	1.80	72	40	0.99	4.50	7.20	0.200	0.470	X	X
72R110X	1.10	2.20	72	40	1.50	5.50	8.20	0.150	0.380	X	X
72R135X	1.35	2.70	72	40	1.70	6.75	9.60	0.120	0.300	X	X
72R160X	1.60	3.20	72	40	1.90	8.00	11.40	0.090	0.220	X	X
72R185X	1.85	3.70	72	40	2.10	9.25	12.60	0.080	0.190	X	X
72R250X	2.50	5.00	72	40	2.50	12.50	15.60	0.050	0.130	X	X
72R300X	3.00	6.00	72	40	2.80	15.00	19.80	0.040	0.100	X	X
72R375X	3.75	7.50	72	40	3.20	18.75	24.00	0.030	0.080	X	X

I_{hold} = Hold current: maximum current device will pass without tripping in 23°C still air.
 I_{trip} = Trip current: minimum current at which the device will trip in 23°C still air.
 V_{max} = Maximum voltage device can withstand without damage at rated current (I_{max})
 I_{max} = Maximum fault current device can withstand without damage at rated voltage (V_{max})
 P_d = Power dissipated from device when in the tripped state at 23°C still air.
 R_{min} = Minimum resistance of device in initial (un-soldered) state.

R_{1max} = Maximum resistance of device at 23°C measured one hour after tripping or reflow soldering of 260°C for 20 sec.

Caution: Operation beyond the specified rating may result in damage and possible arcing and flame.

Temperature Derating

Part Number	Ambient Operation Temperature								
	-40°C	-20°C	0°C	23°C	40°C	50°C	60°C	70°C	85°C
72R020X	0.31	0.27	0.24	0.20	0.16	0.14	0.13	0.11	0.08
72R025X	0.39	0.34	0.30	0.25	0.20	0.18	0.16	0.14	0.10
72R030X	0.47	0.41	0.36	0.30	0.24	0.22	0.19	0.16	0.12
72R040X	0.62	0.54	0.48	0.40	0.32	0.29	0.25	0.22	0.16
72R050X	0.78	0.68	0.60	0.50	0.41	0.36	0.32	0.27	0.20
72R065X	1.01	0.88	0.77	0.65	0.53	0.47	0.41	0.35	0.26
72R075X	1.16	1.02	0.89	0.75	0.61	0.54	0.47	0.41	0.30
72R090X	1.40	1.22	1.07	0.90	0.73	0.65	0.57	0.49	0.36
72R110X	1.71	1.50	1.31	1.10	0.89	0.79	0.69	0.59	0.44
72R135X	2.09	1.84	1.61	1.35	1.09	0.97	0.85	0.73	0.54
72R160X	2.48	2.18	1.90	1.60	1.30	1.15	1.01	0.86	0.64
72R185X	2.87	2.52	2.20	1.85	1.50	1.33	1.17	1.00	0.74
72R250X	3.88	3.40	2.98	2.50	2.03	1.80	1.58	1.35	1.00
72R300X	4.65	4.08	3.57	3.00	2.43	2.16	1.89	1.62	1.20
72R375X	5.81	5.10	4.46	3.75	3.04	2.70	2.36	2.03	1.50

Average Time Current Curves

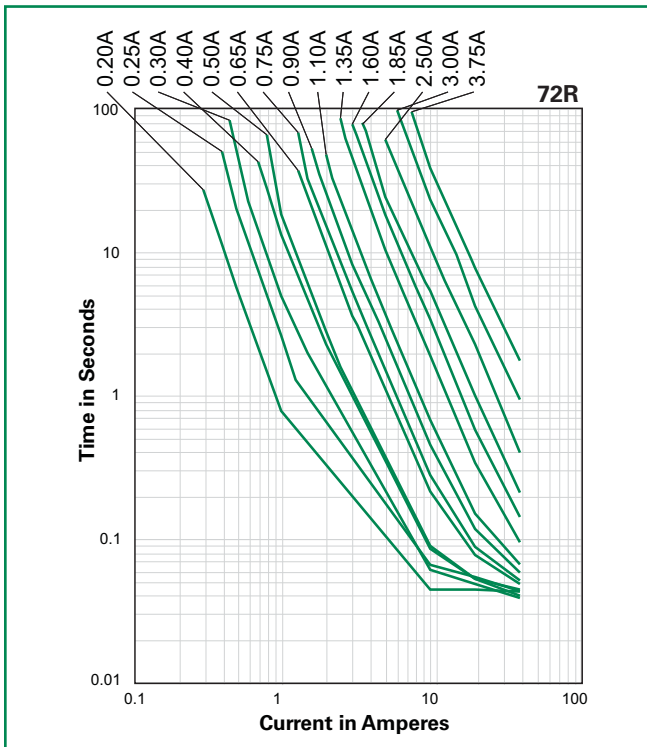

Temperature Derating Curve

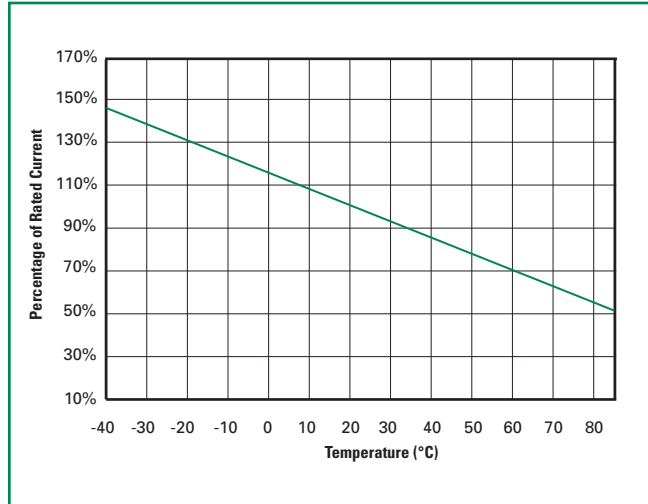

The average time current curves and Temperature Derating curve performance is affected by a number of variables, and these curves provided as guidance only. Customer must verify the performance in their application.

Soldering Parameters - Wave Soldering

Pre-Heating Zone	Refer to the condition recommended by the flux manufacturer. Max. ramping rate should not exceed 4°C/Sec.
Soldering Zone	Max. solder temperature should not exceed 260°C
Cooling Zone	Cooling by natural convection in air.

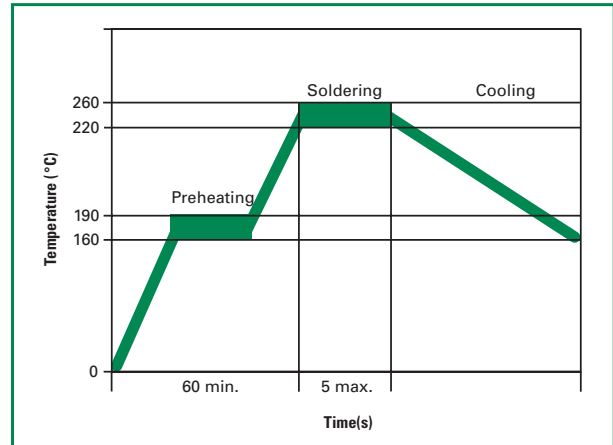

Physical Specifications

Lead Material	0.20-0.40A: Tin-plated Copper clad steel 0.50-3.75A: Tin-plated Copper
Soldering Characteristics	Solderability per MIL-STD-202, Method 208E
Insulating Material	Cured, flame retardant epoxy polymer meets UL 94V-0 requirements.
Lead Solderability	Marked with 'LF', voltage, current rating, and date code.

Environmental Specifications

Operating/Storage Temperature	-40°C to +85°C
Maximum Device Surface Temperature in Tripped State	125°C
Passive Aging	+85°C, 1000 hours -/+5% typical resistance change
Humidity Aging	+85°C, 85% R.H. 1000 hours -/+5% typical resistance change
Thermal Shock	+85°C to -40°C 10 times -/+5% typical resistance change
Solvent Resistance	MIL-STD-202, Method 215F
Moisture Sensitivity Level	Level 2, J-STD-020C

Dimensions

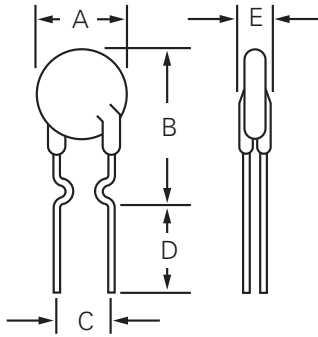

Part Marking System

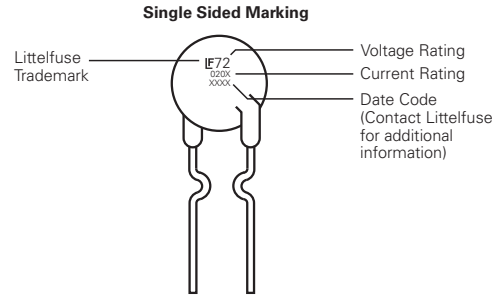

Part Number	A		B		C		D		E		Physical Characteristics		
	Inches	mm	Inches	mm	Inches	mm	Inches	mm	Inches	mm	Lead (dia)		Material
	Max.	Max.	Max.	Max.	Typ.	Typ.	Min.	Min.	Max.	Max.	Inches	mm	
72R020X	0.29	7.4	0.46	11.7	0.20	5.1	0.30	7.6	0.12	3.1	0.02	0.51	Sn/CuFe
72R025X	0.29	7.4	0.50	12.7	0.20	5.1	0.30	7.6	0.12	3.1	0.02	0.51	Sn/CuFe
72R030X	0.29	7.4	0.50	12.7	0.20	5.1	0.30	7.6	0.12	3.1	0.02	0.51	Sn/CuFe
72R040X	0.30	7.6	0.53	13.5	0.20	5.1	0.30	7.6	0.12	3.1	0.02	0.51	Sn/CuFe
72R050X	0.31	7.9	0.54	13.7	0.20	5.1	0.30	7.6	0.12	3.1	0.02	0.51	Sn/Cu
72R065X	0.37	9.4	0.57	14.5	0.20	5.1	0.30	7.6	0.12	3.1	0.02	0.51	Sn/Cu
72R075X	0.40	10.2	0.60	15.2	0.20	5.1	0.30	7.6	0.12	3.1	0.02	0.51	Sn/Cu
72R090X	0.44	11.2	0.62	15.8	0.20	5.1	0.30	7.6	0.12	3.1	0.02	0.51	Sn/Cu
72R110X	0.51	13.0	0.72	18.2	0.20	5.1	0.30	7.6	0.12	3.1	0.03	0.81	Sn/Cu
72R135X	0.53	13.58	0.78	19.8	0.20	5.1	0.30	7.6	0.12	3.1	0.03	0.81	Sn/Cu
72R160X	0.60	15.36	0.85	21.6	0.20	5.1	0.30	7.6	0.12	3.1	0.03	0.81	Sn/Cu
72R185X	0.66	16.76	0.91	23.0	0.20	5.1	0.30	7.6	0.12	3.1	0.03	0.81	Sn/Cu
72R250X	0.78	19.93	1.03	26.2	0.40	10.2	0.30	7.6	0.12	3.1	0.03	0.81	Sn/Cu
72R300X	0.91	23.11	1.15	29.3	0.40	10.2	0.30	7.6	0.12	3.1	0.03	0.81	Sn/Cu
72R375X	1.04	26.3	1.22	31.1	0.40	10.2	0.30	7.6	0.12	3.1	0.03	0.81	Sn/Cu

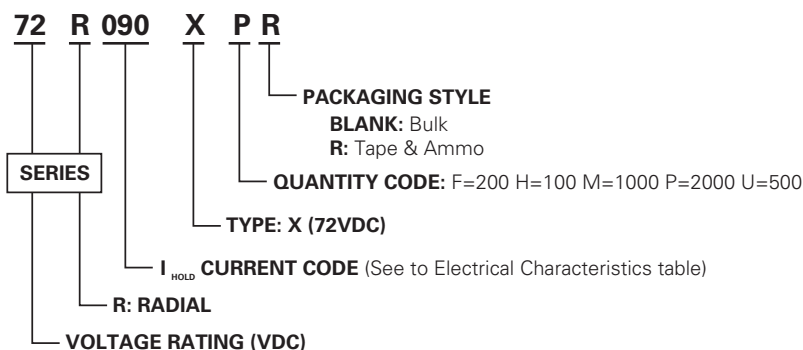
Part Ordering Number System

Packaging

Part Number	Ordering Part Number	I _{hold} (A)	I _{hold} Code	Packaging Option	Quantity	Quantity & Packaging Codes
72R020X	72R020XU	0.20	020	Bulk	500	U
	72R020XPR			Tape and Ammo	2000	PR
72R025X	72R025XU	0.25	025	Bulk	500	U
	72R025XPR			Tape and Ammo	2000	PR
72R030X	72R030XU	0.30	030	Bulk	500	U
	72R030XPR			Tape and Ammo	2000	PR
72R040X	72R040XU	0.40	040	Bulk	500	U
	72R040XPR			Tape and Ammo	2000	PR
72R050X	72R050XU	0.50	050	Bulk	500	U
	72R050XPR			Tape and Ammo	2000	PR
72R065X	72R065XU	0.65	065	Bulk	500	U
	72R065XPR			Tape and Ammo	2000	PR
72R075X	72R075XU	0.75	075	Bulk	500	U
	72R075XPR			Tape and Ammo	2000	PR
72R090X	72R090XU	0.90	090	Bulk	500	U
	72R090XPR			Tape and Ammo	2000	PR
72R110X	72R110XU	1.10	110	Bulk	500	U
	72R110XMR			Tape and Ammo	1000	MR
72R135X	72R135XF	1.35	135	Bulk	200	F
	72R135XMR			Tape and Ammo	1000	MR
72R160X	72R160XF	1.60	160	Bulk	200	F
	72R160XMR			Tape and Ammo	1000	MR
72R185X	72R185XF	1.85	185	Bulk	200	F
	72R185XMR			Tape and Ammo	1000	MR
72R250X	72R250XF	2.50	250	Bulk	200	F
	72R250XMR			Tape and Ammo	1000	MR
72R300X	72R300XF	3.00	300	Bulk	200	F
	72R300XMR			Tape and Ammo	1000	MR
72R375X	72R375XH	3.75	375	Bulk	100	H

Tape and Reel Specifications

Devices taped using EIA468-B/E286-2 standards. See table below and Figures 1 and 2 for details.

Dimension	EIA Mark	IEC Mark	Dimensions	
			Dim. (mm)	Tol. (mm)
Carrier tape width	W	W	18	-0.5 / +1.0
Hold down tape width	W₄	W₀	11	min.
Top distance between tape edges	W₆	W₂	3	max.
Sprocket hole position	W₅	W₁	9	-0.5 / +0.75
Sprocket hole diameter*	D₀	D₀	4	-0.32 / +0.2
Abscissa to plane (straight lead)	H	H	18.5	-/+ 3.0
Abscissa to plane (kinked lead)	H₀	H₀	16	-/+ 0.5
Abscissa to top 72R020X-72R090X	H₁	H₁	32.2	max.
Abscissa to top 72R110X-72R300X	H₁		47.5	max.
Overall width without lead protrusion: 72R020X-72R090X	C₁		42.5	max.
Overall width without lead protrusion: 72R110X-72R300X			57	
Overall width with lead protrusion: 72R020X-72R090X	C₂		43.2	max.
Overall width with lead protrusion: 72R110X-72R300X		58		
Lead protrusion	L₁	I₁	1.0	max.
Protrusion of cut out	L	L	11	max.
Protrusion beyond hold-down tape	I₂	I₂	Not specified	
Sprocket hole pitch: 72R020X-72R090X	P₀	P₀	12.7	-/+ 0.3
Sprocket hole pitch: 72R110X-72R300X	P₀	P₀	25.4	-/+ 0.5
Pitch tolerance			20 consecutive.	-/+ 1
Device pitch: 72R020X-72R090X			12.7	
Device pitch: 72R110X-72R300X			25.4	
Tape thickness	t	t	0.9	max.
Tape thickness with splice	t₁		2.0	max.
Splice sprocket hole alignment			0	-/+ 0.3
Body lateral deviation	Δh	Δh	0	-/+ 1.0
Body tape plane deviation	Δp	Δp	0	-/+ 1.3
Ordinate to adjacent component lead*: 72R020X-72R090X	P₁	P₁	3.81	-/+ 0.7
Ordinate to adjacent component lead*: 72R110X-72R300X			7.62	-/+ 0.7
Lead spacing: 72R020X-72R185X	F	F	5.08	-/+ 0.8
Lead spacing: 72R250X-72R300X	F	F	10.18	-/+ 0.8
Reel width: 72R020X-72R065X	w₂	w	56	max.
Reel width: 72R075X-72R300X	w₂	w	63.5	max.
Reel diameter	a	d	370	max.
Space between flanges less device*	w₁		4.75	-3.25 / +9.25
Arbor hole diameter	c	f	26	-/+ 12.0
Core diameter*	n	h	91	max.
Box			56/372/372	max.
Consecutive missing places			None	
Empty places per reel			0.1% max.	

*Differs from EIA Specification

Tape and Reel Diagram

Figure 1

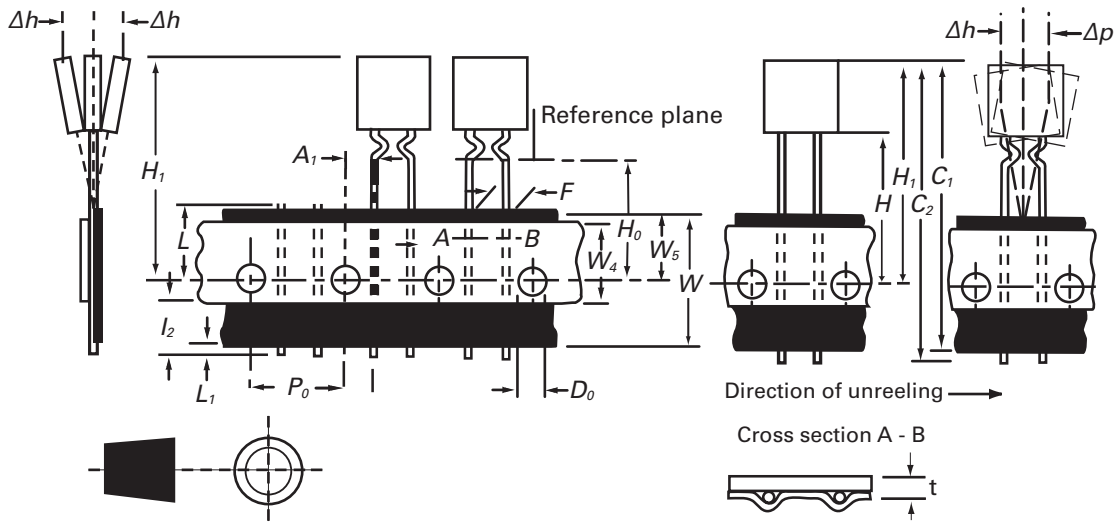
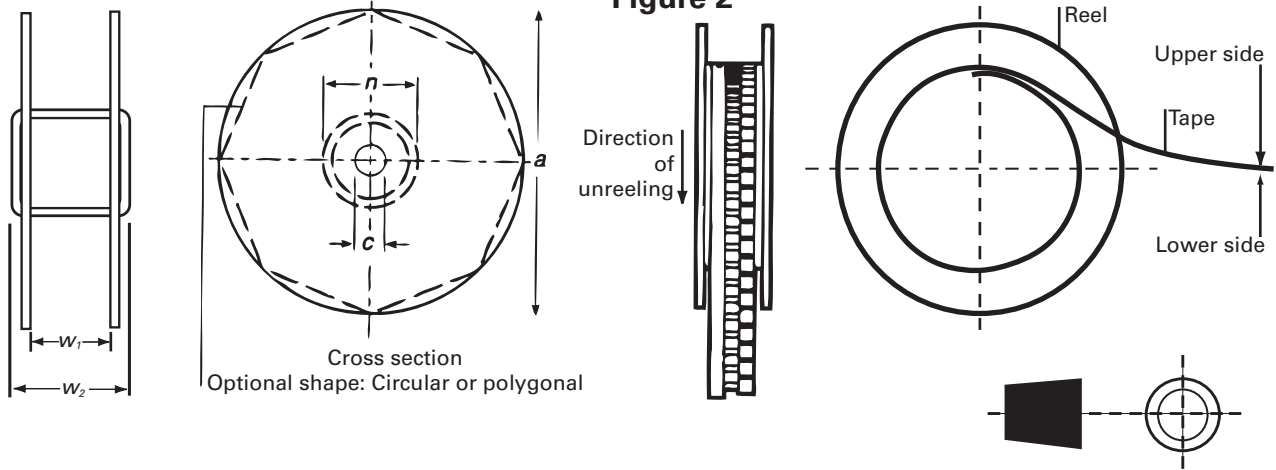
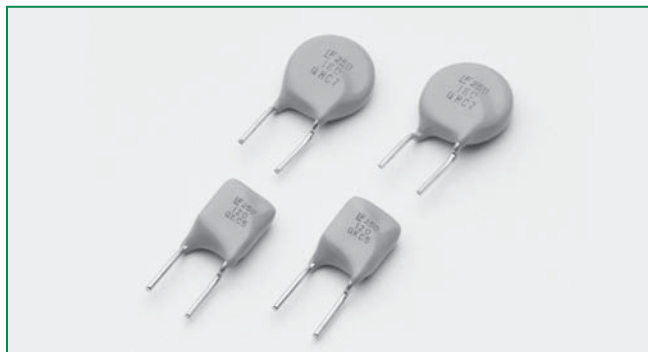

Figure 2





Description

The 250R Series is designed to protect against short duration high voltage fault currents (power cross or power induction surge) typically found in telecom applications (250Vrms). The series can be used to help telecom networking equipment meet the protection requirements specified in ITU K.20 and K.21.

Features

- RoHS compliant and lead-free
- Fast time-to-trip
- Binned and sorted narrow resistance ranges available
- 0.08 – 0.18 hold current range, 60VDC operating voltage
- 250VAC interrupt rating

Agency Approvals

AGENCY AGENCY FILE NUMBER



E183209





R50120008

Applications

- Customer Premises Equipment (CPE)
- Central Office (CO)/telecom centers
- LAN/WAN equipment
- Access equipment

Electrical Characteristics

Part Number	I _{hold} (A)	I _{trip} (A)	V _{max} V _{int} / V _{op}	I _{max} (A)	P _d max. (W)	Maximum Time To Trip		Resistance			Agency Approvals	
						Current (A)	Time (Sec.)	R _{min} (Ω)	R _{typ} (Ω)	R _{1max} (Ω)		
250R080	0.08	0.16	250/60	3	1	0.35	3	14	22	33	X	X
250R080T	0.08	0.16	250/60	3	1	0.35	3	15	22	33	X	X
250R120	0.12	0.24	250/60	3	1	1	1.5	4	8	16	X	X
250R120-RA	0.12	0.24	250/60	3	1	1	1.0	7	9	16	X	X
250R120-RC	0.12	0.24	250/60	3	1	1	0.85	5.4	7.5	14	X	X
250R120-RF	0.12	0.24	250/60	3	1	1	0.7	6	10.5	16	X	X
250R120-R1	0.12	0.24	250/60	3	1	1	0.8	6	9	16	X	X
250R120-R2	0.12	0.24	250/60	3	1	1	0.7	8	10.5	16	X	X
250R120-R3	0.12	0.24	250/60	3	1	1	1	8	10	16	X	X
250R120T	0.12	0.24	250/60	3	1	1	1.2	7	12	16	X	X
250R145	0.145	0.29	250/60	3	1	1	2.5	3	6	14	X	X
250R145-RA	0.145	0.29	250/60	3	1	1	5	3	5.5	12	X	X
250R145-RB	0.145	0.29	250/60	3	1	1	2.5	4.5	6	14	X	X
250R145T	0.145	0.29	250/60	3	1	1	2.0	5.4	7.5	14	X	X
250R180	0.18	0.65	250/60	10	1.8	1	21	0.8	2.2	4	X	X
250R180T	0.18	0.65	250/60	10	1.8	1	20	1.4	3.9	4.5	X	X

Items with T at end of part number = pre-tripped device. See Part Ordering Number System section of this data sheet for additional information.

I_{hold} = Hold current: maximum current device will pass without tripping in 23°C still air.

I_{trip} = Trip current: minimum current at which the device will trip in 23°C still air.

V_{int} = Maximum voltage the device can withstand without damage at rated current (I_{max})

V_{op} = The device regular operation voltage

I_{max} = Maximum fault current device can withstand without damage at rated voltage (V_{max})

P_d = Power dissipated from device when in the tripped state at 23°C still air.

R_{min} = Minimum resistance of device in initial (un-soldered) state.

R_{typ} = Typical resistance of device in initial (un-soldered) state.

R_{1max} = Maximum resistance of device at 20°C measured one hour after tripping.

Caution: Operation beyond the specified rating may result in damage and possible arcing and flame.

Temperature Rerating

Part Number	Ambient Operation Temperature								
	-40°C	-20°C	0°C	23°C	40°C	50°C	60°C	70°C	85°C
250R080	0.12	0.11	0.09	0.08	0.06	0.05	0.05	0.04	0.03
250R080T	0.12	0.11	0.09	0.08	0.06	0.05	0.05	0.04	0.03
250R120	0.18	0.16	0.14	0.12	0.10	0.09	0.08	0.06	0.05
250R120T	0.18	0.16	0.14	0.12	0.10	0.09	0.08	0.06	0.05
250R145	0.26	0.20	0.17	0.145	0.12	0.11	0.09	0.08	0.06
250R145T	0.26	0.20	0.17	0.145	0.12	0.11	0.09	0.08	0.06
250R180	0.28	0.23	0.21	0.18	0.16	0.13	0.10	0.11	0.083
250R180T	0.28	0.23	0.21	0.18	0.16	0.13	0.10	0.11	0.083

Average Time Current Curves

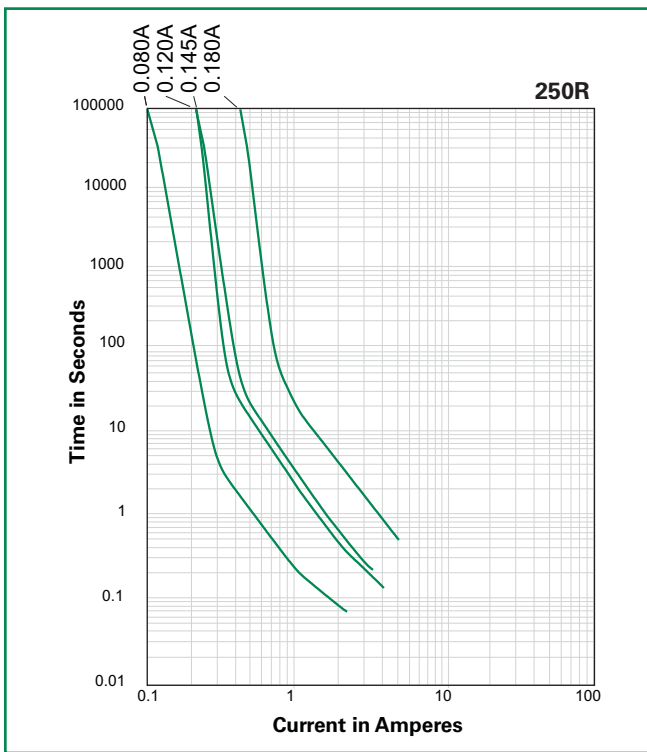

Temperature Rerating Curve

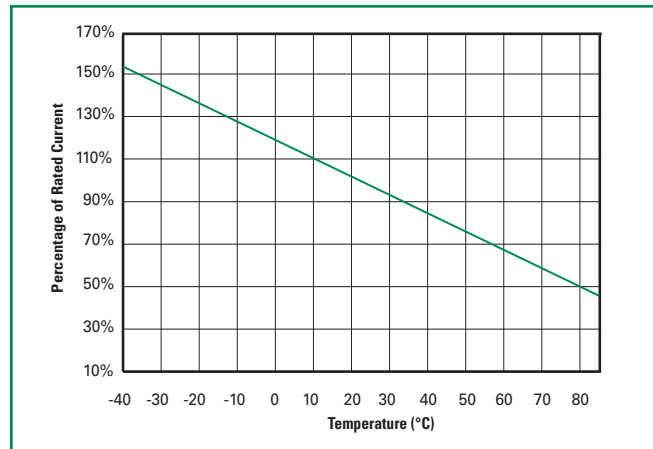

The average time current curves and Temperature Rerating curve performance is affected by a number of variables, and these curves provided as guidance only. Customer must verify the performance in their application.

Agency Specification Selection Guide For Telecom and Networking Applications

Product	Lightning	Power Cross
250R120 250R145	ITU K.20/21/45 – 1.5kV 10/700µs ITU K.20/21/45 – 4kV 10/700µs*	ITU K.20/21/45 – 230Vac, 10Ω ITU K.20/21/45 – 600Vac, 600Ω
250R180	ITU K.20/21/45 – 1.5kV 10/700µs ITU K.20/21/45 – 4kV 10/700µs* Telcordia GR – 974 – 1.0kV 10/1000µs	ITU K.20/21/45 – 230Vac, 10Ω ITU K.20/21/45 – 600Vac, 600Ω Telcordia GR – 974- 283Vac, 10A

*Devices should be independently evaluated and tested for use in any specific application

Protection Application Guide

Region/Specification	Application	Device Selection
South America/Asia/Europe ITU K.45	*Access network equipment Remote terminal Repeaters WAN equipment Cross –connect	250R180 250R180T 250R145 250R145T 250R120 250R120T
South America/Asia/Europe ITU K.21	Customer and IT equipment Analog modems ADSL, xDSL Phone sets, PBX systems Internet appliances POS terminals	250R180 250R180T 250R145 250R145T 250R120 250R120T
South America/Asia/Europe ITU K.20	Central Office POTS/ISDN linecards T1/E1/J1 linecards ADSL/VDSL splitters CSU/DSU	250R180 250R180T 250R145 250R145T 250R120 250R120T
North America Telcordia GR-974	*Primary protection modules MDF modules Network interface	250R180 250R180T 250R145 250R145T 250R120 250R120T
South America/Asia/Europe ITU K.20		
North America Telcordia GR-1089	*Intrabuilding communication systems LAN, VOIP cards Local loop handsets	250R180 250R180T 250R145 250R145T 250R120 250R120T
South America/Asia/Europe ITU K.20 and K.21		
	LAN Intrabuilding power cross Protection LAN equipment, IP phone	250R080

*Resistance binned parts are recommended

Soldering Parameters - Wave Soldering

Condition	Wave Soldering
Peak Temp/ DurationTime	260°C ≤ 5 Sec
≥ 220°C	2 Sec ~ 20 Sec
Preheat 140°C ~ 180°C	180 Sec ~ 210 Sec
Storage Condition	0°C~35°C ≤ 70%RH

- Recommended soldering methods: heat element oven or N₂ environment for lead-free.
- Devices are designed to be wave soldered to the bottom side of the board.
- Devices can be cleaned using standard industry methods and solvents.
- This profile can be used for lead-free device

Note: If soldering temperatures exceed the recommended profile, devices may not meet the performance requirements.

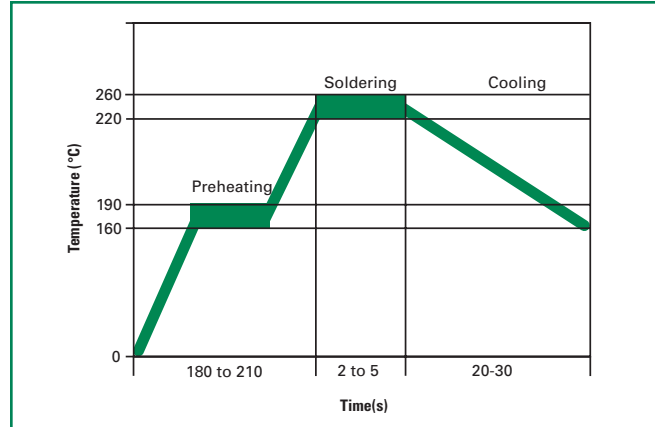

Soldering Parameters - Solder Reflow

Condition	Reflow
Peak Temp/ DurationTime	260°C ≥ 5 Sec
≥ 220°C	30 Sec ~ 60 Sec
Preheat 160°C ~ 190°C	60 Sec ~ 90 Sec
Storage Condition	0°C~35°C, ≤ 70%RH

- Recommended reflow methods: IR, vapor phase oven, hot air oven, N₂ environment for lead-free.
- Devices are not designed to be wave soldered to the bottom side of the board.
- Devices can be cleaned using standard industry methods and solvents.

Note: If reflow temperatures exceed the recommended profile, devices may not meet the performance requirements.

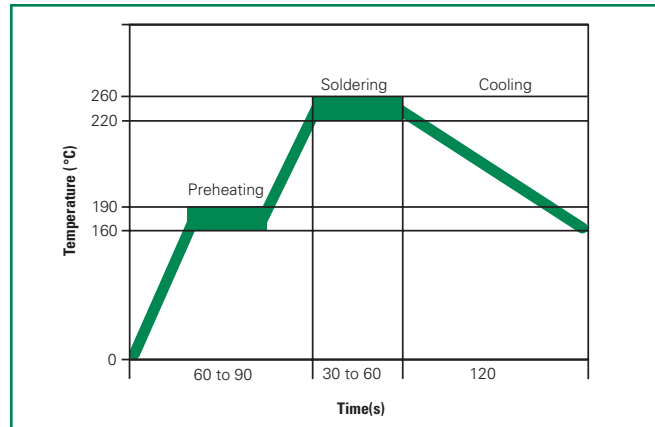

Physical Specifications

Lead Material	Tin-plated Copper
Soldering Characteristics	Solderability per MIL-STD-202, Method 208E
Insulating Material	Cured, flame retardant epoxy polymer meets UL94V-0 requirements.
Device Labeling	Marked with 'LF', voltage, current rating, and date code.

Environmental Specifications

Operating/Storage Temperature	-40°C to +85°C
Maximum Device Surface Temperature in Tripped State	125°C
Passive Aging	65°C/85°C, 1000 hours
Humidity Aging	+85°C, 85% R.H., 1000 hours
Thermal Shock	MIL-STD-202F, Method 107G +125°C to -55°C 10 times
Solvent Resistance	MIL-STD-202, Method 215F
Moisture Sensitivity Level	Level 2, J-STD-020C

Dimensions

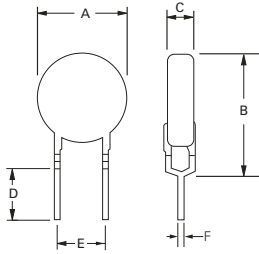

Figure 1

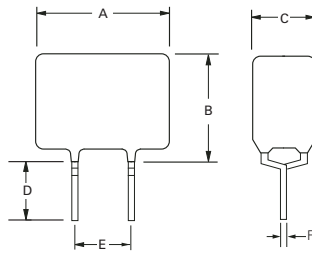
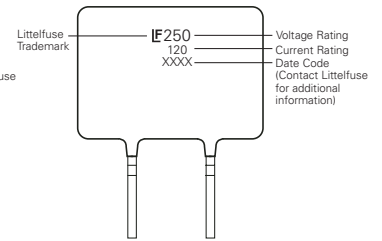
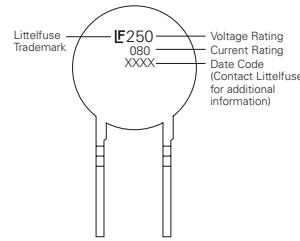

Figure 2

Part Marking System



Part Number	Figure	A		B		C		D		E		Physical Characteristics		
		Inches	mm	Inches	mm	Inches	mm	Inches	mm	Inches	mm	Lead (dia)		Material
		Max.	Max.	Max.	Max.	Max.	Max.	Min.	Min.	Typ.	Typ.	Inches	mm	
250R080	1	0.23	5.8	0.39	9.9	0.18	4.6	0.19	4.7	0.20	5.1	0.026	0.65	Sn/Cu
250R080T	1	0.23	5.8	0.39	9.9	0.18	4.6	0.19	4.7	0.20	5.1	0.026	0.65	Sn/Cu
250R120	2	0.26	6.5	0.43	11	0.15	3.8	0.19	4.7	0.20	5.1	0.026	0.65	Sn/Cu
250R120-RA	2	0.26	6.5	0.43	11	0.18	4.6	0.19	4.7	0.20	5.1	0.026	0.65	Sn/Cu
250R120-RC	2	0.26	6.5	0.43	11	0.18	4.6	0.19	4.7	0.20	5.1	0.026	0.65	Sn/Cu
250R120-RF	2	0.26	6.5	0.43	11	0.18	4.6	0.19	4.7	0.20	5.1	0.026	0.65	Sn/Cu
250R120-R1	2	0.26	6.5	0.43	11	0.18	4.6	0.19	4.7	0.20	5.1	0.026	0.65	Sn/Cu
250R120-R2	2	0.26	6.5	0.43	11	0.18	4.6	0.19	4.7	0.20	5.1	0.026	0.65	Sn/Cu
250R120-R3	2	0.26	6.5	0.43	11	0.18	4.6	0.19	4.7	0.20	5.1	0.026	0.65	Sn/Cu
250R120T	2	0.26	6.5	0.43	11	0.18	4.6	0.19	4.7	0.20	5.1	0.026	0.65	Sn/Cu
250R145	2	0.26	6.5	0.43	11	0.18	4.6	0.19	4.7	0.20	5.1	0.026	0.65	Sn/Cu
250R145-RA	2	0.26	6.5	0.43	11	0.18	4.6	0.19	4.7	0.20	5.1	0.026	0.65	Sn/Cu
250R145-RB	2	0.26	6.5	0.43	11	0.18	4.6	0.19	4.7	0.20	5.1	0.026	0.65	Sn/Cu
250R145T	2	0.26	6.5	0.43	11	0.18	4.6	0.19	4.7	0.20	5.1	0.026	0.65	Sn/Cu
250R180	1	0.37	9.5	0.47	12	0.18	4.6	0.19	4.7	0.20	5.1	0.026	0.65	Sn/Cu
250R180T	1	0.37	9.5	0.47	12	0.18	4.6	0.19	4.7	0.20	5.1	0.026	0.65	Sn/Cu

250R Series

Tape and Reel Specifications

Devices taped using EIA468-B/IE286-2 standards. See table below and Figures 1 and 2 for details.

Dimension	EIA Mark	IEC Mark	Dimensions	
			Dim. (mm)	Tol. (mm)
Carrier tape width	W	W	18	-0.5 / +1.0
Hold down tape width	W₄	W₀	11	min.
Top distance between tape edges	W₆	W₂	3	max.
Sprocket hole position	W₅	W₁	9	-0.5 / +0.75
Sprocket hole diameter*	D₀	D₀	4	-0.32 / +0.2
Abscissa to plane (straight lead)	H	H	18.5	-/+ 3.0
Abscissa to plane (kinked lead)	H₀	H₀	16	-/+ 0.5
Abscissa to top	H₁	H₁	32.2	max.
Overall width without lead protrusion	C₁		42.5	max.
Overall width with lead protrusion	C₂		43.2	max.
Lead protrusion	L₁	I₁	1.0	max.
Protrusion of cut out	L	L	11	max.
Protrusion beyond hold-down tape	I₂	I₂	Not specified	
Sprocket hole pitch: 250R080–250R145	P₀	P₀	12.7	-/+ 0.3
Sprocket hole pitch: 250R180	P₀	P₀	25.4	-/+ 0.5
Pitch tolerance			20 consecutive.	-/+ 1
Device pitch: 250R080–250R145			12.7	
Device pitch: 250R180			25.4	
Tape thickness	t	t	0.9	max.
Tape thickness with splice	t₁		2.0	max.
Splice sprocket hole alignment			0	-/+ 0.3
Body lateral deviation	Δh	Δh	0	-/+ 1.0
Body tape plane deviation	Δp	Δp	0	-/+ 1.3
Ordinate to adjacent component lead*	P₁	P₁	3.81	-/+ 0.7
Lead spacing	F	F	5.1	-/+ 0.7
Reel width	w₂	w	56	max.
Reel diameter	a	d	370	max.
Space between flanges less device*	w₁		4.75	-3.25 / +8.25
Arbor hole diameter	c	f	26	-/+ 12.0
Core diameter*	n	h	91	max.
Box			56/372/372	max.
Consecutive missing places			None	
Empty places per reel			0.1% max.	

*Differs from EIA Specification

Tape and Reel Diagram

Figure 1

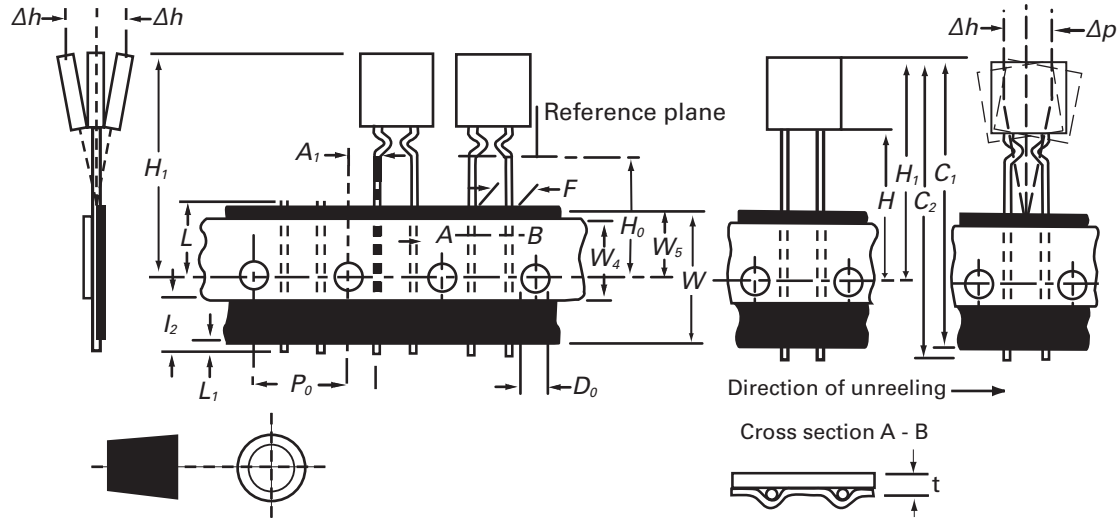
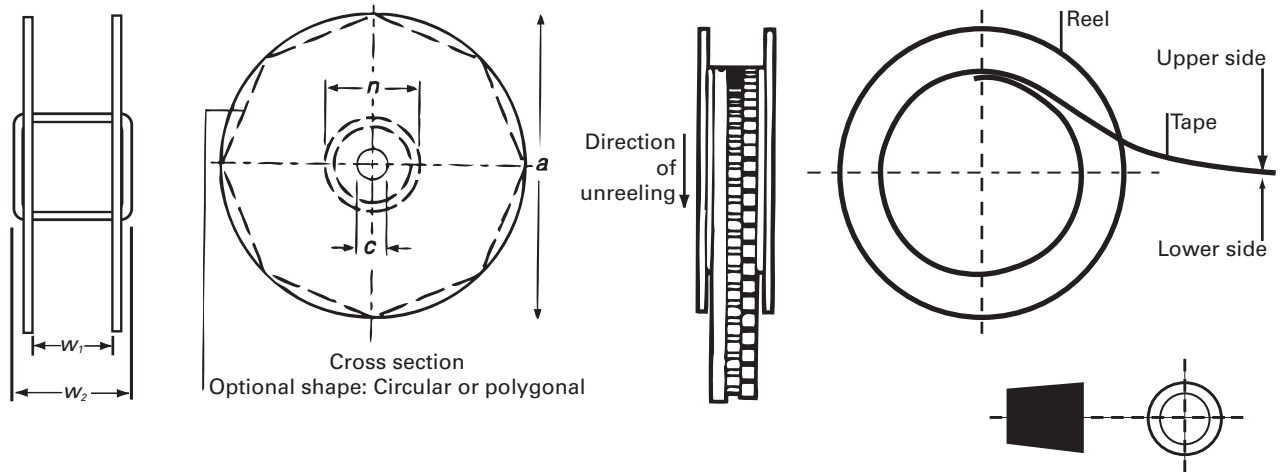
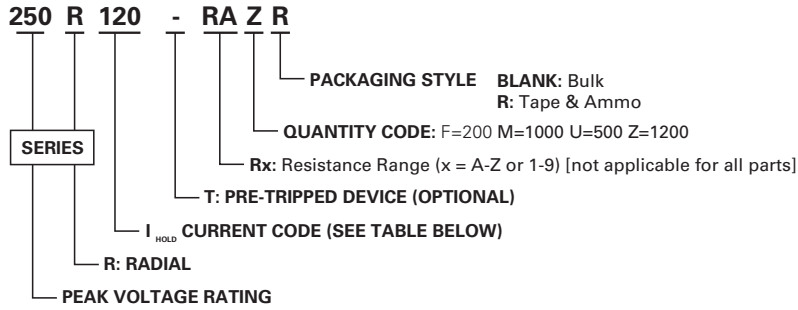

Figure 2



250R Series

Part Ordering Number System



Packaging

Part Number	Ordering Number	I _{hold} (A)	I _{hold} Code	Packaging Option	Quantity	Quantity & Packaging Codes
250R080	250R080U	0.080	080	Bulk	500	U
	250R080ZR			Tape and Ammo	1200	ZR
250R080T	250R080TU	0.080	080	Bulk	500	U
	250R080TZR			Tape and Ammo	1200	ZR
250R120	250R120U	0.120	120	Bulk	500	U
	250R120ZR			Tape and Ammo	1200	ZR
250R120-RA	250R120-RAU	0.120	120	Bulk	500	U
	250R120-RAZR			Tape and Ammo	1200	ZR
250R120-RC	250R120-RCU	0.120	120	Bulk	500	U
	250R120-RCZR			Tape and Ammo	1200	ZR
250R120-RF	250R120-RFU	0.120	120	Bulk	500	U
	250R120-RFZR			Tape and Ammo	1200	ZR
250R120-R1	250R120-R1U	0.120	120	Bulk	500	U
	250R120-R1ZR			Tape and Ammo	1200	ZR
250R120-R2	250R120-R2U	0.120	120	Bulk	500	U
	250R120-R2ZR			Tape and Ammo	1200	ZR
250R120-R3	250R120-R3U	0.120	120	Bulk	500	U
	250R120-R3ZR			Tape and Ammo	1200	ZR
250R120T	250R120TU	0.120	120	Bulk	500	U
	250R120TZR			Tape and Ammo	1200	ZR
250R145	250R145U	0.145	145	Bulk	500	U
	250R145ZR			Tape and Ammo	1200	ZR
250R145-RA	250R145-RAU	0.145	145	Bulk	500	U
	250R145-RAZR			Tape and Ammo	1200	ZR
250R145-RB	250R145-RBU	0.145	145	Bulk	500	U
	250R145-RBZR			Tape and Ammo	1200	ZR
250R145T	250R145TU	0.145	145	Bulk	500	U
	250R145TZR			Tape and Ammo	1200	ZR
250R180	250R180F	0.180	180	Bulk	200	F
	250R180MR			Tape and Ammo	1000	MR
250R180T	250R180TF	0.180	180	Bulk	200	F
	250R180TMR			Tape and Ammo	1000	MR

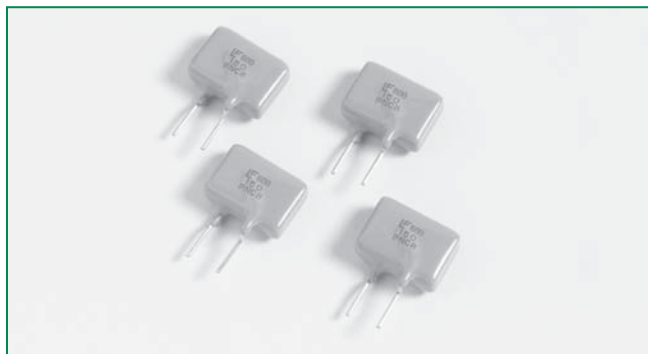

Description

- The 600R Series is designed to protect against power fault events typically found in telecom applications. This series is designed to be used in applications that need to meet the requirements of GR-1089-CORE and UL60950/EN60950/IEC60950. These resettable devices also help to meet the requirements of ITU K.20, K.21 and K.44.



Features

- RoHS compliant and lead-free
- Fast time-to-trip
- Binned and sorted narrow resistance ranges available
- 0.15 – 0.16A hold current range, 60VDC operating voltage
- 600VAC interrupt rating



Applications

- Secondary overcurrent protection for:
- Central Office Equipment (CO)
 - Customer Premises Equipment (CE)
 - Alarm systems
 - Set Top Boxes (STB)
 - Voice over IP (VOIP)
 - Subscriber Line Interface Circuit (SLIC)

Agency Approvals

AGENCY	AGENCY FILE NUMBER
	E183209
	R50120008

Electrical Characteristics

Part Number	I _{hold} (A)	I _{trip} (A)	V _{max} V _{int} / V _{op}	I _{max} (A)	P _{d max.} (W)	Maximum Time To Trip		Resistance			Agency Approvals	
						Current (A)	Time (Sec.)	R _{min} (Ω)	R _{typ} (Ω)	R _{1max} (Ω)		
600R150	0.15	0.30	600/60	3	1.00	5.0	8.0	6	12	22	X	X
600R150-RA	0.15	0.30	600/60	3	1.00	5.0	7.5	7	10	20	X	X
600R150-RB	0.15	0.30	600/60	3	1.00	4.5	-	9	12	22	X	X
600R160	0.16	0.32	600/60	3	1.00	7.5	18	4	10	18	X	X
600R160-RA	0.16	0.32	600/60	3	1.00	9.5	-	4	7	16	X	X
600R160-R1	0.16	0.32	600/60	3	1.00	9.0	-	4	8	17	X	X

I_{hold} = Hold current: maximum current device will pass without tripping in 23°C still air.
 I_{trip} = Trip current: minimum current at which the device will trip in 23°C still air.
 V_{int} = Maximum voltage the device can withstand without damage at rated current (I_{max})
 V_{op} = The device regular operation voltage
 I_{max} = Maximum fault current device can withstand without damage at rated voltage (V_{max})
 P_d = Power dissipated from device when in the tripped state at 23°C still air.

R_{min} = Minimum resistance of device in initial (un-soldered) state.
 R_{typ} = Typical resistance of device in initial (un-soldered) state.
 R_{1max} = Maximum resistance of device at 20°C measured one hour after tripping.
Caution: Operation beyond the specified rating may result in damage and possible arcing and flame.

Temperature Rerating

Part Number	Ambient Operation Temperature						
	-40°C	-20°C	0°C	23°C	40°C	60°C	85°C
600R150	0.26	0.23	0.19	0.15	0.124	0.062	0.03
600R160	0.27	0.24	0.20	0.16	0.13	0.07	0.05

Average Time Current Curves

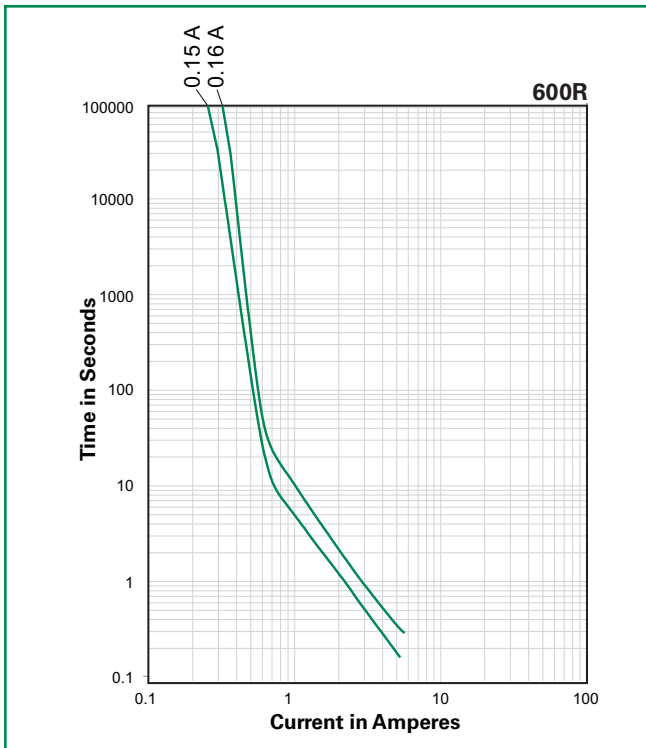

Temperature Rerating Curve

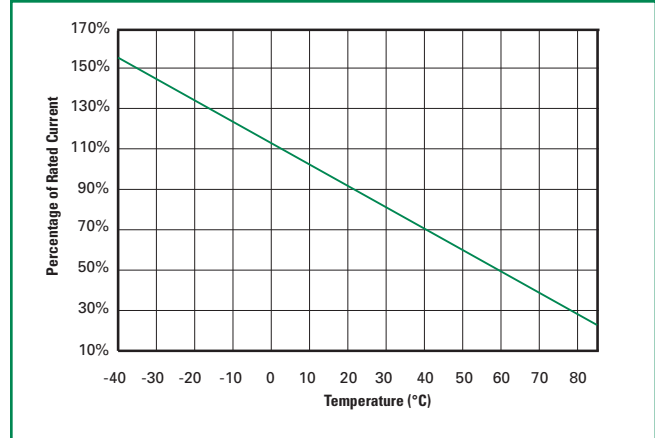

The average time current curves and Temperature Rerating curve performance is affected by a number of variables, and these curves provided as guidance only. Customer must verify the performance in their application.

Agency Specification Selection Guide For Telecom and Networking Applications

Part Number	Lightning	Power Cross
600R150 600R160	TIA-968-A – 1.5kV 10/160µs 800V 10/560µs Telcordia GR 1089 – 1.0kV 10/1000µs 2.5kV 2/10µs	UL60950, 3rd Ed – 600Vac, 40A Telcordia GR – 1089 – 600Vac, 60A

Devices should be independently evaluated and tested for use in any specific application

Protection Application Guide

Region/Specification	Application	Device Selection
North America Telcordia GR-1089	*Access network equipment Remote terminal Repeaters WAN equipment Cross -connect	600R150 600R160
North America TIA-968-A, UL60950	Customer and IT equipment Analog modems ADSL, XDSL modems Phone sets, PBX systems Internet appliances POS terminals	600R150 600R160
North America Telcordia GR-1089	Central Office POTS/ISDN linecards T1/E1/J1 linecards ADSL/VDSL splitters CSU/DSU	600R150 600R160
North America Telcordia GR-1089 South America/Asia/Europe ITU K.20 and K.21	*Intrabuilding communication systems LAN, VOIP cards Local loop handsets	600R150 600R160

*Resistance binned parts are recommended

Soldering Parameters - Wave Soldering

Condition	Wave Soldering
Peak Temp/ DurationTime	260°C ≤ 5 Sec
≥ 220°C	2 Sec ~ 20 Sec
Preheat 140°C~ 180°C	180 Sec ~ 210 Sec
Storage Condition	0°C~35°C, ≤ 70%RH

- Recommended soldering methods: heat element oven or N₂ environment for lead-free
- Devices are designed to be wave soldered to the bottom side of the board.
- Devices can be cleaned using standard industry methods and solvents.
- This profile can be used for lead-free device

Note: If soldering temperatures exceed the recommended profile, devices may not meet the performance requirements.

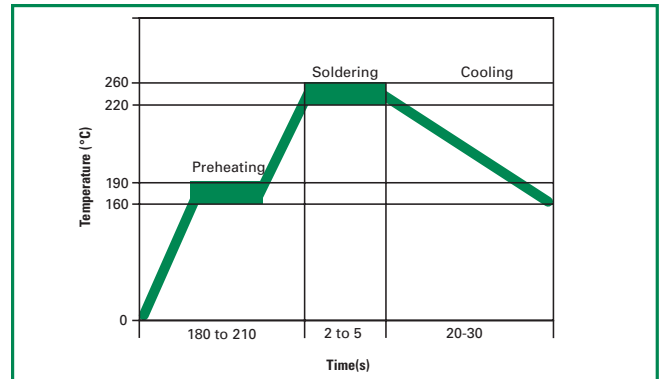

Soldering Parameters - Solder Reflow

Condition	Reflow
Peak Temp/ DurationTime	260°C ≥ 5 Sec
≥ 220°C	30 Sec ~ 60 Sec
Preheat 160°C~ 190°C	60 Sec ~ 90 Sec
Storage Condition	0°C~35°C, ≤ 70%RH

- Recommended reflow methods: IR, vapor phase oven, hot air oven, N₂ environment for lead-free.
- Devices are not designed to be wave soldered to the bottom side of the board.
- Devices can be cleaned using standard industry methods and solvents.

Note: If reflow temperatures exceed the recommended profile, devices may not meet the performance requirements.

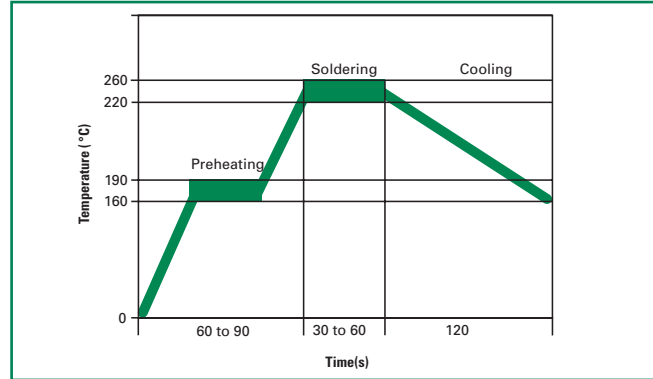

Physical Specifications

Lead Material	Tin-plated Copper
Soldering Characteristics	Solderability per MIL-STD-202, Method 208E
Insulating Material	Cured, flame retardant epoxy polymer meets UL94V-0 requirements.
Device Labeling	Marked with 'LF', voltage, current rating, and date code.

Environmental Specifications

Operating/Storage Temperature	-40°C to +85°C
Maximum Device Surface Temperature in Tripped State	125°C
Passive Aging	85°C/85°C, 1000 hours
Humidity Aging	+85°C, 85% R.H., 1000 hours
Thermal Shock	MIL-STD-202F, Method 107G +125°C to -55°C 10 times
Solvent Resistance	MIL-STD-202, Method 215F

Dimensions

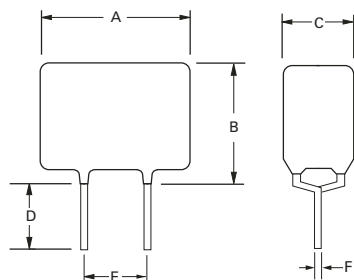

Part Marking System

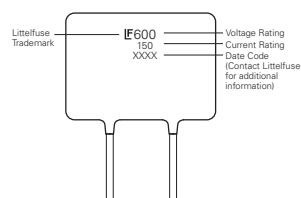

Part Number	A		B		C		D		E		Physical Characteristics		
	Inches	mm	Inches	mm	Inches	mm	Inches	mm	Inches	mm	Lead (dia)		Material
	Max.	Max.	Max.	Max.	Max.	Max.	Min.	Min.	Typ.	Typ.	Inches	mm	
600R150	0.53	13.5	0.50	12.6	0.24	6	0.19	4.7	0.20	5.1	0.026	0.65	Sn/Cu
600R150-RA	0.53	13.5	0.50	12.6	0.24	6	0.19	4.7	0.20	5.1	0.026	0.65	Sn/Cu
600R150-RB	0.53	13.5	0.50	12.6	0.24	6	0.19	4.7	0.20	5.1	0.026	0.65	Sn/Cu
600R160	0.63	16	0.50	12.6	0.24	6	0.19	4.7	0.20	5.1	0.026	0.65	Sn/Cu
600R160-RA	0.63	16	0.50	12.6	0.24	6	0.19	4.7	0.20	5.1	0.026	0.65	Sn/Cu
600R160-R1	0.63	16	0.50	12.6	0.24	6	0.19	4.7	0.20	5.1	0.026	0.65	Sn/Cu

Part Ordering Number System

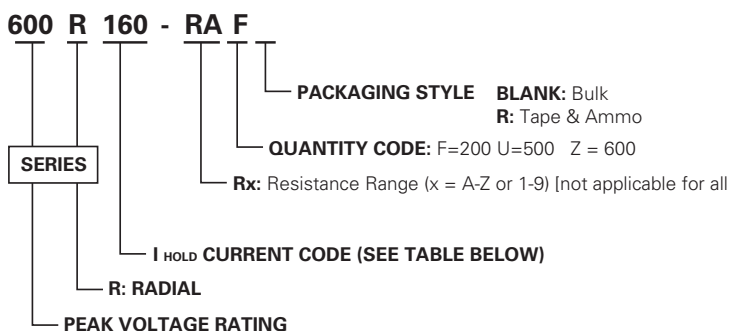

Packaging

Part Number	Ordering Number	I _{hold} (A)	I _{hold} Code	Packaging Option	Quantity	Quantity & Packaging Codes
600R150	600R150F	0.15	150	Bulk	200	F
	600R150ZR			Tape and Ammo	600	ZR
600R150-RA	600R150-RAF	0.15	150	Bulk	200	F
	600R150-RAZR			Tape and Ammo	600	ZR
600R150-RB	600R150-RBF	0.15	150	Bulk	200	F
	600R150-RBZR			Tape and Ammo	600	ZR
600R160	600R160F	0.16	160	Bulk	200	F
	600R160UR			Tape and Ammo	500	UR
600R160-RA	600R160-RAF	0.16	160	Bulk	200	F
	600R160-RAUR			Tape and Ammo	500	UR
600R160-R1	600R160-R1F	0.16	160	Bulk	200	F
	600R160-R1UR			Tape and Ammo	500	UR

Tape and Reel Specifications

Devices taped using EIA468-B/IE286-2 standards. See table below and Figures 1 and 2 for details.

Dimension	EIA Mark	IEC Mark	Dimensions	
			Dim. (mm)	Tol. (mm)
Carrier tape width	W	W	18	-0.5 / +1.0
Hold down tape width:	W₄	W₀	11	min.
Top distance between tape edges	W₆	W₂	3	max.
Sprocket hole position	W₅	W₁	9	-0.5 / +0.75
Sprocket hole diameter*	D₀	D₀	4	-0.32 / +0.2
Abscissa to plane(straight lead)	H	H	18.5	-/+ 3.0
Abscissa to plane(kinked lead)	H₀	H₀	16	-/+ 0.5
Abscissa to top	H₁	H₁	32.2	max.
Overall width w/o lead protrusion	C₁		42.5	max.
Overall width w/ lead protrusion	C₂		43.2	max.
Lead protrusion	L₁	I₁	1.0	max.
Protrusion of cut out	L	L	11	max.
Protrusion beyond hold-down tape	I₂	I₂	Not specified	
Sprocket hole pitch: 600R150 & 600R160	P₀	P₀	25.4	-/+ 0.5
Device pitch: 600R150 & 600R160			25.4	
Pitch tolerance			20 consecutive.	-/+ 1
Tape thickness	t	t	0.9	max.
Tape thickness with splice	t₁		2.0	max.
Splice sprocket hole alignment			0	-/+ 0.3
Body lateral deviation	Δh	Δh	0	-/+ 1.0
Body tape plane deviation	Δp	Δp	0	-/+ 1.3
Ordinate to adjacent component lead*	P₁	P₁	3.81	-/+ 0.7
Lead spacing:	F	F	5.08	-/+ 0.8
Reel width	w₂	w	56	max.
Reel diameter	a	d	370	max.
Space between flanges less device*	w₁		4.75	-3.25 / +8.25
Arbor hole diameter	c	f	26	-/+ 12.0
Core diameter*	n	h	91	max.
Box			56/372/372	max.
Consecutive missing places			None	
Empty places per reel			0.1% max.	
Reel width: 600R150-600R160	w₂	w	63.5	max.
Reel diameter	a	d	370	max.
Space between flanges less device*	w₁		4.75	-3.25 / +9.25
Arbor hole diameter	c	f	26	-/+ 12.0
Core diameter*	n	h	91	max.
Box			56/372/372	max.
Consecutive missing places			None	
Empty places per reel			0.1% max.	

*Differs from EIA Specification

Tape and Reel Diagram

Figure 1

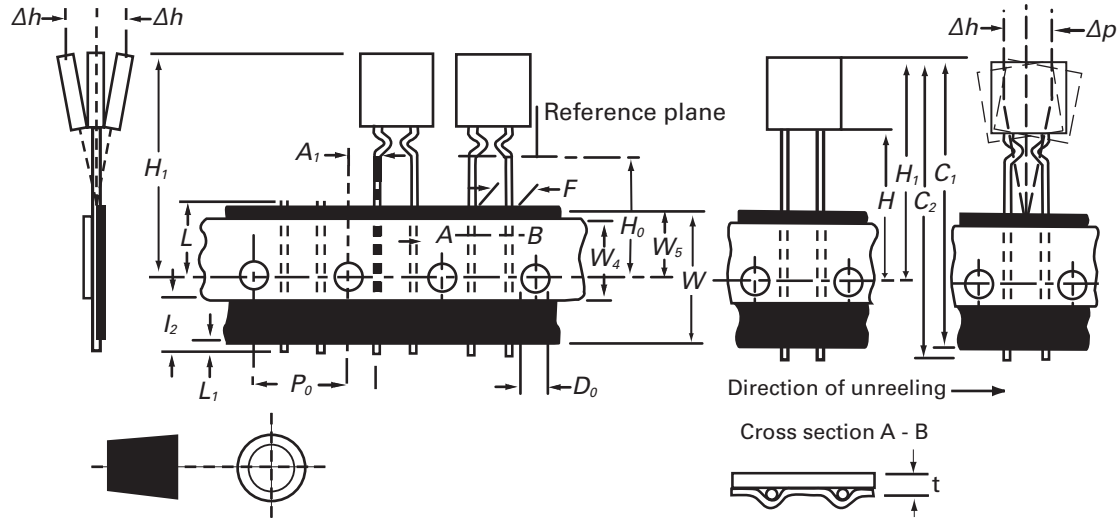
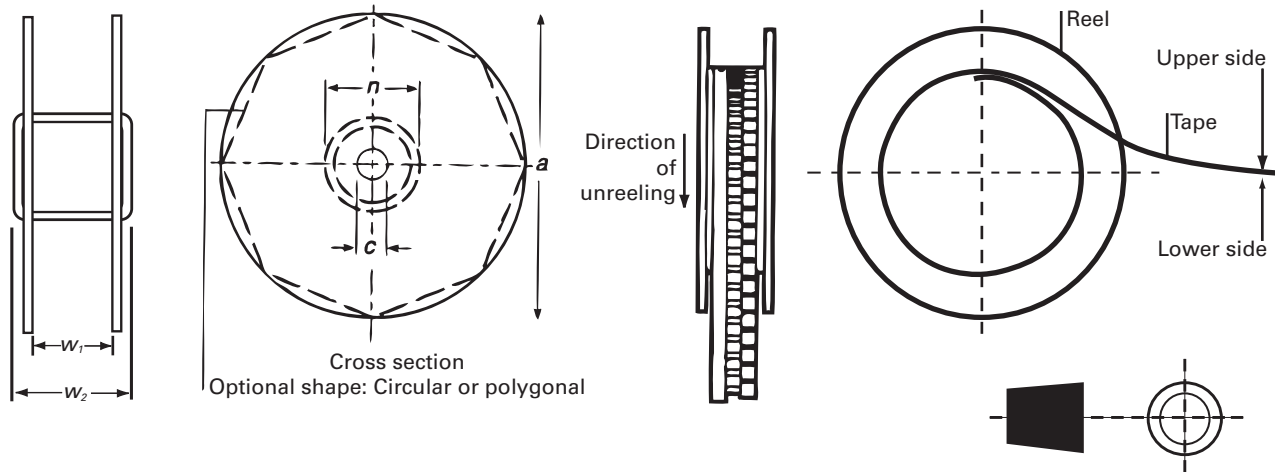
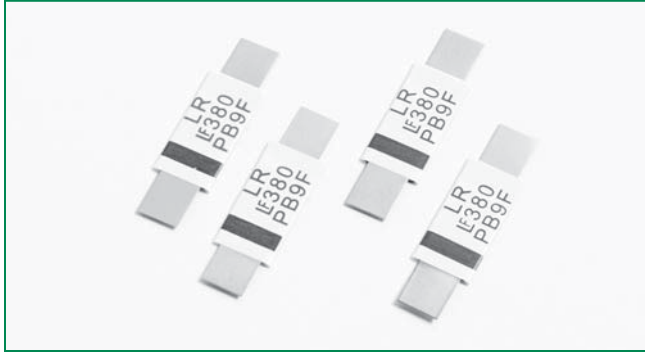

Figure 2



600R Series



Description

The new LR Series device provides reliable, noncycling protection against overcharging and short circuits events for rechargeable battery cells where resettable protection is desired.



Features

- RoHS compliant and lead-free
- Weldable Nickel terminals
- Slim, low profile design
- Compact design saves board space
- Low resistance
- Fast trip time



Applications

- Rechargeable battery cell protection
- Portable Computers
- Camcorders

Agency Approvals

AGENCY	AGENCY FILE NUMBER
	E183209
	R50119583

Electrical Characteristics

Part Number	I _{hold} (A)	I _{trip} (A)	V _{max} (Vdc)	I _{max} (A)	P _{d max.} (W)	Maximum Time To Trip		Resistance			Agency Approvals	
						Current (A)	Time (Sec.)	R _{min} (Ω)	R _{typ} (Ω)	R _{1max} (Ω)		
15LR190	1.9	3.9	15	100	1.2	9.50	5.00	0.039	0.072	0.102	X	X
15LR190S	1.9	3.9	15	100	1.2	9.50	5.00	0.039	0.072	0.102	X	X
15LR260	2.6	5.8	15	100	2.5	13.00	5.00	0.020	0.042	0.063	X	X
15LR260S	2.6	5.8	15	100	2.5	13.00	5.00	0.020	0.042	0.063	X	X
15LR380	3.8	8.3	15	100	2.5	19.00	5.00	0.013	0.026	0.037	X	X
20LR450	4.5	8.9	20	100	2.5	22.50	5.00	0.011	0.020	0.028	X	X
20LR550	5.5	10.5	20	100	2.8	27.50	5.00	0.009	0.016	0.022	X	X
20LR600	6.0	11.7	20	100	2.8	30.00	5.00	0.007	0.014	0.019	X	X
20LR730	7.3	14.1	20	100	3.3	30.00	5.00	0.006	0.012	0.015	X	X

I_{hold} = Hold current: maximum current device will pass without tripping in 20°C still air.

I_{trip} = Trip current: minimum current at which the device will trip in 20°C still air.

V_{max} = Maximum voltage device can withstand without damage at rated current (I_{max})

I_{max} = Maximum fault current device can withstand without damage at rated voltage (V_{max})

P_d = Power dissipated from device when in the tripped state at 20°C still air.

R_{min} = Minimum resistance of device in initial (un-soldered) state.

R_{typ} = Typical resistance of device in initial (un-soldered) state.

R_{1max} = Maximum resistance of device at 20°C measured one hour after tripping or reflow soldering of 260°C for 20 sec.

Caution: Operation beyond the specified rating may result in damage and possible arcing and flame.

Temperature Derating

Part Number	Ambient Operation Temperature								
	-40°C	-20°C	0°C	23°C	40°C	50°C	60°C	70°C	85°C
15LR190	2.80	2.50	2.30	1.90	1.60	1.50	1.40	1.20	1.00
15LR190S	2.80	2.50	2.30	1.90	1.60	1.50	1.40	1.20	1.00
15LR260	3.80	3.40	3.10	2.60	2.20	2.00	1.90	1.70	1.40
15LR260S	3.80	3.40	3.10	2.60	2.20	2.00	1.90	1.70	1.40
15LR380	5.50	4.90	4.40	3.80	3.30	3.00	2.80	2.50	2.10
20LR450	6.50	5.80	5.30	4.50	3.90	3.60	3.30	2.90	2.50
20LR550	8.00	7.10	6.20	5.50	4.70	4.30	4.00	3.60	3.00
20LR600	8.70	7.80	7.10	6.00	5.20	4.70	4.40	3.90	3.30
20LR730	10.60	9.50	8.60	7.30	6.30	5.70	5.40	4.70	4.00

Average Time Current Curves

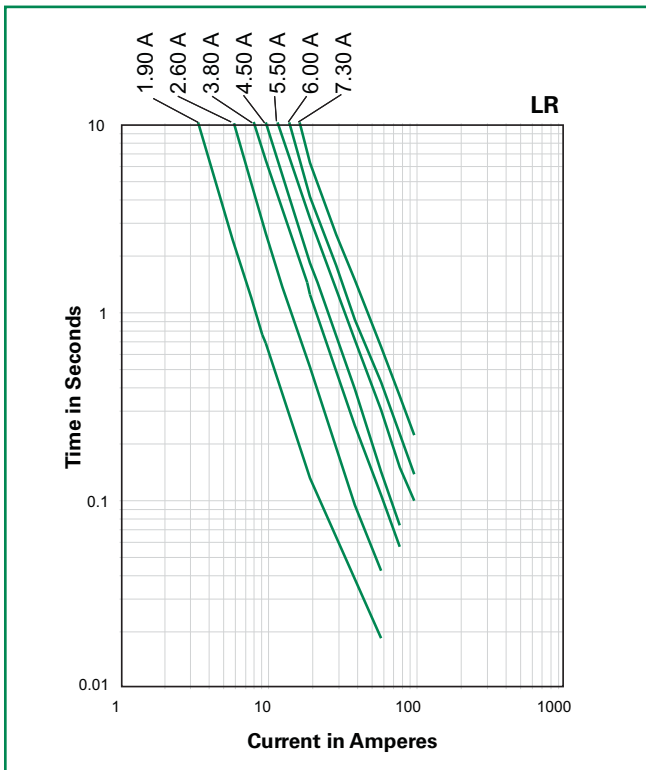

Temperature Derating Curve

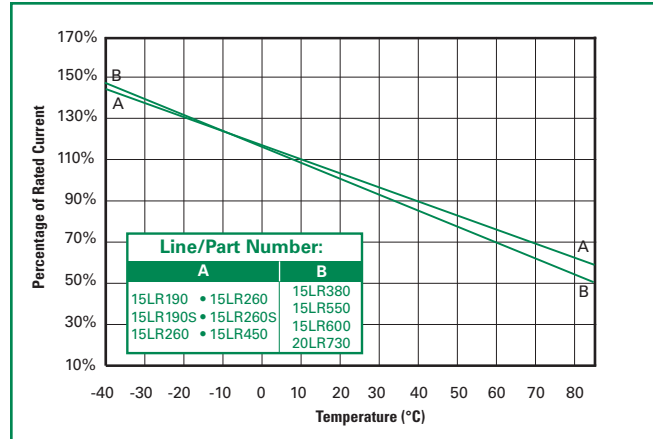

The average time current curves and Temperature Derating curve performance is affected by a number of variables, and these curves provided as guidance only. Customer must verify the performance in their application.

Physical Specifications

Terminal Material	0.13mm nominal thickness, quarter-hard Nickel
Insulating Material	Polyester tape

Environmental Specifications

Operating/Storage Temperature	-40°C to +85°C
Maximum Device Surface Temperature in Tripped State	125°C
Passive Aging	+70°C, 1000 hours -/+10% typical resistance change
Humidity Aging	+85°C, 85% R.H., 7 days -/+5% typical resistance change
Vibration	MIL-STD-883C, Method 2007.1, Condition A, No change

Dimensions

Figure 1

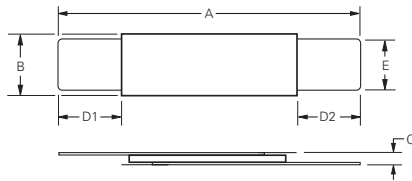
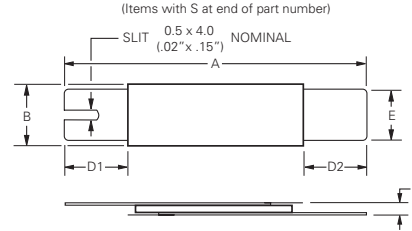
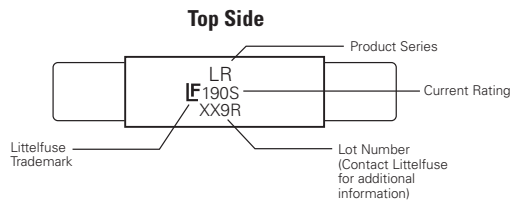

Figure 2



Part Number	Figure	A				B				C				D1		D2		E			
		Inches		mm		Inches		mm		Inches		mm		Inches	mm	Inches	mm	Inches		mm	
		Min.	Max.	Min.	Max.	Min.	Max.	Min.	Max.	Min.	Max.	Min.	Max.	Min.	Max.	Min.	Max.	Min.	Max.	Min.	Max.
15LR190	1	0.78	0.87	19.90	22.10	0.19	0.22	4.90	5.50	0.02	0.04	0.60	1.00	0.22	5.50	0.22	5.50	0.01	0.22	3.90	4.10
15LR190S	2	0.78	0.87	19.90	22.10	0.19	0.22	4.90	5.50	0.02	0.04	0.60	1.00	0.22	5.50	0.22	5.50	0.01	0.22	3.90	4.10
15LR260	1	0.82	0.91	20.90	23.10	0.19	0.22	4.90	5.50	0.02	0.04	0.60	1.00	0.16	4.10	0.16	4.10	0.01	0.16	3.90	4.10
15LR260S	2	0.82	0.91	20.90	23.10	0.19	0.22	4.90	5.50	0.02	0.04	0.60	1.00	0.16	4.10	0.16	4.10	0.01	0.16	3.90	4.10
15LR380	1	0.94	1.02	24.00	26.00	0.27	0.30	6.90	7.50	0.02	0.04	0.60	1.00	0.16	4.10	0.16	4.10	0.01	0.16	4.90	5.10
20LR450	1	0.94	1.02	24.00	26.00	0.39	0.41	9.90	10.50	0.02	0.04	0.60	1.00	0.21	5.30	0.21	5.30	0.01	0.21	5.90	6.10
20LR550	1	1.38	1.46	35.00	37.00	0.27	0.30	6.90	7.50	0.02	0.04	0.60	1.00	0.21	5.30	0.21	5.30	0.01	0.21	4.90	5.10
20LR600	1	0.94	1.02	24.00	26.00	0.55	0.57	13.90	14.50	0.02	0.04	0.60	1.00	0.16	4.10	0.16	4.10	0.01	0.16	5.90	6.10
20LR730	1	1.07	1.15	27.10	29.10	0.55	0.57	13.90	14.50	0.02	0.04	0.60	1.00	0.16	4.10	0.16	4.10	0.01	0.16	5.90	6.10

Part Marking System



LR Series

Part Ordering Number System

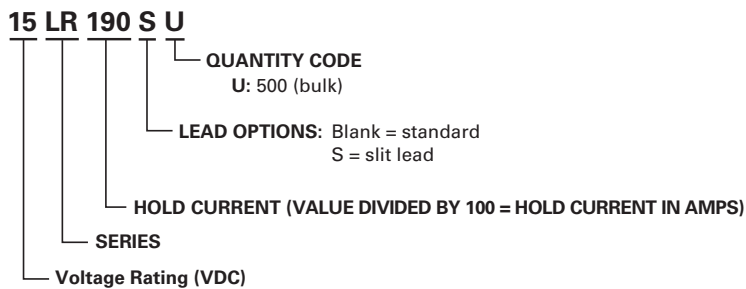

Packaging

Part Number	Ordering Number	I_{hold} (A)	I_{hold} Code	Packaging Option	Quantity	Quantity & Packaging Codes
15LR190	15LR190U	1.9	190	Bulk	500	U
15LR190S	15LR190SU	1.9	190	Bulk	500	U
15LR260	15LR260U	2.6	260	Bulk	500	U
15LR260S	15LR260SU	2.6	260	Bulk	500	U
15LR380	15LR380U	3.8	380	Bulk	500	U
20LR450	20LR450U	4.5	450	Bulk	500	U
20LR550	20LR550U	5.5	550	Bulk	500	U
20LR600	20LR600U	6.0	600	Bulk	500	U
20LR730	20LR730U	7.3	730	Bulk	500	U



Description

The new LT Series device provides reliable, noncycling protection against overcharging and short circuits events for rechargeable battery cells where resettable protection is desired.

Features

- RoHS compliant and lead-free
- Weldable Nickel terminals
- Compact design saves board space
- Low resistance
- Provides overcurrent protection at 100°C trip temperature

Agency Approvals

AGENCY AGENCY FILE NUMBER



E183209





R50119583

Applications

- Rechargeable battery cell protection
 - Mobile phones
 - Laptop computers

Electrical Characteristics

Part Number	I _{hold} (A)	I _{trip} (A)	V _{max} (Vdc)	I _{max} (A)	P _{d max.} (W)	Maximum Time To Trip		Resistance			Agency Approvals	
						Current (A)	Time (Sec.)	R _{min} (Ω)	R _{typ} (Ω)	R _{1max} (Ω)		
15LT070	0.7	1.5	15	100	1.0	3.50	5.00	0.100	0.200	0.340	X	X
15LT070S	0.7	1.5	15	100	1.0	3.50	5.00	0.100	0.200	0.340	X	X
24LT100	1.0	2.5	24	100	1.5	5.00	7.00	0.070	0.130	0.260	X	X
24LT100S	1.0	2.5	24	100	1.5	5.00	7.00	0.070	0.130	0.260	X	X
24LT100SS	1.0	2.5	24	100	1.5	5.00	7.00	0.070	0.130	0.260	X	X
24LT180	1.8	3.8	24	100	2.0	9.00	2.90	0.040	0.068	0.120	X	X
24LT180S	1.8	3.8	24	100	2.0	9.00	2.90	0.040	0.068	0.120	X	X
24LT180SS	1.8	3.8	24	100	2.0	9.00	2.90	0.040	0.068	0.120	X	X
24LT190	1.9	4.2	24	100	1.9	10.00	3.00	0.030	0.057	0.100	X	X
24LT190S	1.9	4.2	24	100	1.9	10.00	3.00	0.030	0.057	0.100	X	X
24LT260	2.6	5.2	24	100	2.3	13.0	5.0	0.025	0.042	0.076	X	X
24LT300	3.0	6.3	24	100	2.0	15.0	4.0	0.015	0.031	0.055	X	X
24LT310	3.1	6.0	24	100	2.5	16.0	5.0	0.018	0.030	0.055	X	X
24LT340	3.4	6.8	24	100	2.7	17.0	5.0	0.016	0.027	0.050	X	X

Items with S and SS at end of part number identify items with slit lead option. See Dimension Drawing and Part Ordering Number System sections of this document for more information.

I_{hold} = Hold current: maximum current device will pass without tripping in 20°C still air.

I_{trip} = Trip current: minimum current at which the device will trip in 20°C still air.

V_{max} = Maximum voltage device can withstand without damage at rated current (I_{max})

I_{max} = Maximum fault current device can withstand without damage at rated voltage (V_{max})

P_d = Power dissipated from device when in the tripped state at 20°C still air.

R_{min} = Minimum resistance of device in initial (un-soldered) state.

R_{typ} = Typical resistance of device in initial (un-soldered) state.

R_{1max} = Maximum resistance of device at 20°C measured one hour after tripping or reflow soldering of 260°C for 20 sec.

Caution: Operation beyond the specified rating may result in damage and possible arcing and flame.

Temperature Rerating

Part Number	Ambient Operation Temperature								
	-40°C	-20°C	0°C	20°C	40°C	50°C	60°C	70°C	85°C
	Hold Current (A)								
15LT070	1.20	1.09	0.85	0.70	0.50	0.45	0.35	0.28	0.16
15LT070S	1.20	1.09	0.85	0.70	0.50	0.45	0.35	0.28	0.16
24LT100	1.86	1.60	1.40	1.00	0.80	0.70	0.60	0.44	0.23
24LT100S	1.86	1.60	1.40	1.00	0.83	0.70	0.60	0.44	0.23
24LT100SS	1.86	1.60	1.40	1.00	0.83	0.70	0.60	0.44	0.23
24LT180	3.13	2.68	2.20	1.80	1.33	1.10	0.90	0.65	0.36
24LT180S	3.13	2.68	2.20	1.80	1.33	1.10	0.90	0.65	0.36
24LT180SS	3.13	2.68	2.20	1.80	1.33	1.10	0.90	0.65	0.36
24LT190	3.32	2.86	2.40	1.90	1.48	1.25	1.10	0.79	0.43
24LT260	4.30	3.72	3.10	2.60	1.98	1.69	1.40	1.11	0.60
24LT300	5.10	4.40	3.70	3.00	2.30	1.95	1.60	1.25	0.69
24LT310	5.36	4.58	3.70	3.10	2.36	2.01	1.70	1.30	0.71
24LT340	5.52	4.79	4.00	3.40	2.60	2.24	1.90	1.51	0.78

Average Time Current Curves

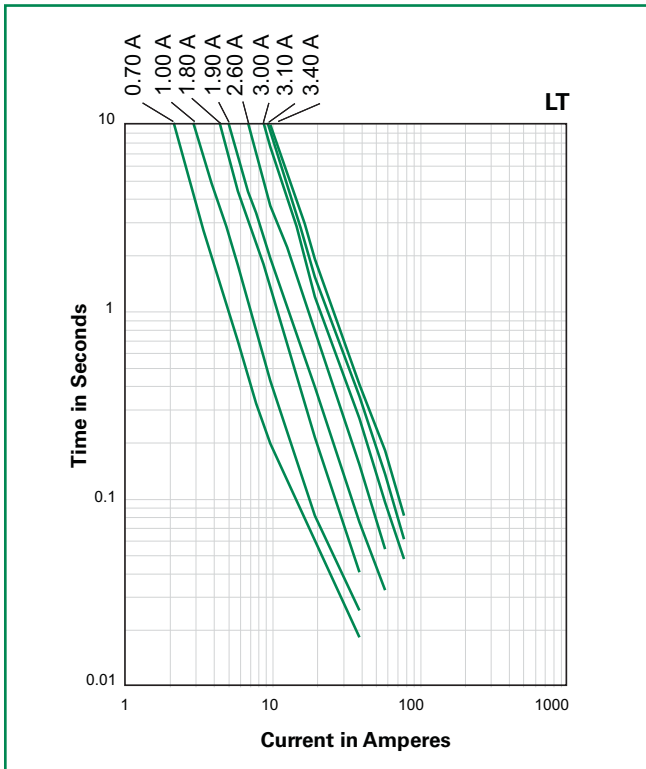

Temperature Rerating Curve

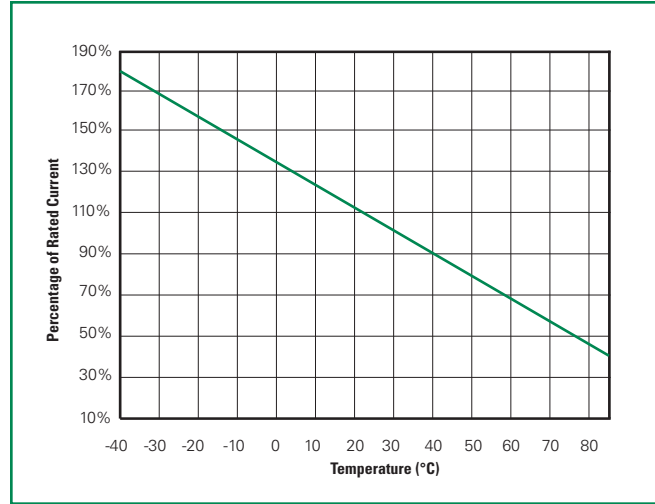

The average time current curves and Temperature Rerating curve performance is affected by a number of variables, and these curves provided as guidance only. Customer must verify the performance in their application.

Physical Specifications

Terminal Material	0.13mm nominal thickness, quarter-hard Nickel
Insulating Material	Polyester tape

Environmental Specifications

Operating/Storage Temperature	-40°C to +85°C
Maximum Device Surface Temperature in Tripped State	125°C
Passive Aging	+70°C, 1000 hours -/+10% typical resistance change
Humidity Aging	+85°C, 85% R.H., 7 days, -/+5% typical resistance change
Vibration	MIL-LTD-883C, Condition A, No change

Dimensions

Figure 1

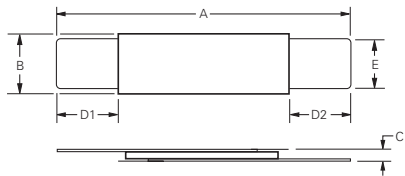

Figure 2

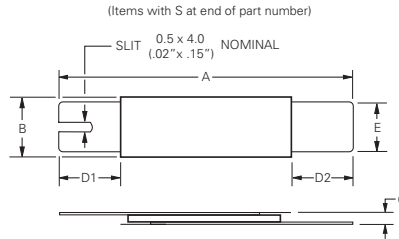
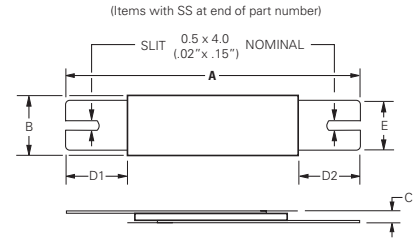

Figure 3



Part Number	Fig.	A				B				C				D1		D2		E			
		Inches		mm		Inches		mm		Inches		mm		in.	mm	in.	mm	Inches		mm	
		Min.	Max.	Min.	Max.	Min.	Max.	Min.	Max.	Min.	Max.	Min.	Max.	Min.	Min.	Min.	Min.	Min.	Max.	Min.	Max.
15LT070	1	0.78	0.87	19.9	22.1	0.19	0.20	4.9	5.2	0.03	0.05	0.7	1.2	0.22	5.5	0.22	5.5	0.01	0.22	3.9	4.1
15LT070S	2	0.78	0.87	19.9	22.1	0.19	0.20	4.9	5.2	0.03	0.05	0.7	1.2	0.22	5.5	0.22	5.5	0.01	0.22	3.9	4.1
24LT100	1	0.82	0.91	20.9	23.1	0.19	0.20	4.9	5.2	0.02	0.04	0.6	1	0.16	4.1	0.16	4.1	0.01	0.16	3.9	4.1
24LT100S	2	0.82	0.91	20.9	23.1	0.19	0.20	4.9	5.2	0.02	0.04	0.6	1	0.16	4.1	0.16	4.1	0.01	0.16	3.9	4.1
24LT100SS	3	0.82	0.91	20.9	23.1	0.19	0.20	4.9	5.2	0.02	0.04	0.6	1	0.16	4.1	0.16	4.1	0.01	0.16	3.9	4.1
24LT180	1	0.94	1.02	24	26	0.19	0.20	4.9	5.2	0.02	0.04	0.6	1	0.16	4.1	0.16	4.1	0.01	0.16	3.9	4.1
24LT180S	2	0.94	1.02	24	26	0.19	0.20	4.9	5.2	0.02	0.04	0.6	1	0.16	4.1	0.16	4.1	0.01	0.16	3.9	4.1
24LT180SS	3	0.94	1.02	24	26	0.19	0.20	4.9	5.2	0.02	0.04	0.6	1	0.16	4.1	0.16	4.1	0.01	0.16	3.9	4.1
24LT190	1	0.84	0.92	21.3	23.4	0.40	0.43	10.2	11	0.02	0.04	0.5	1	0.20	5	0.20	5	0.01	0.20	4.8	5.4
24LT190S	2	0.84	0.92	21.3	23.4	0.40	0.43	10.2	11	0.02	0.04	0.5	1	0.20	5	0.20	5	0.01	0.20	4.8	5.4
24LT260	1	0.94	1.02	24	26	0.43	0.47	10.8	11.9	0.02	0.04	0.6	1	0.20	5	0.20	5	0.01	0.20	5.9	6.1
24LT300	1	1.12	1.25	28.4	31.8	0.51	0.53	13	13.5	0.02	0.04	0.5	1.1	0.25	6.3	0.25	6.3	0.00	0.25	6	6.6
24LT310	1	0.94	1.02	24	26	0.58	0.63	14.8	15.9	0.02	0.04	0.6	1	0.20	5	0.20	5	0.01	0.20	5.9	6.1
24LT340	1	0.94	1.02	24	26	0.58	0.63	14.8	15.9	0.02	0.04	0.6	1	0.20	5	0.20	5	0.01	0.20	5.9	6.1

LT Series

Part Marking System

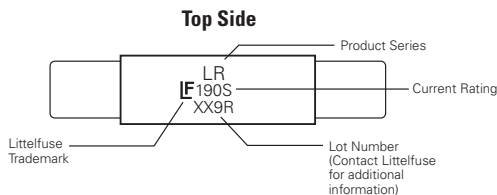

Part Ordering Number System

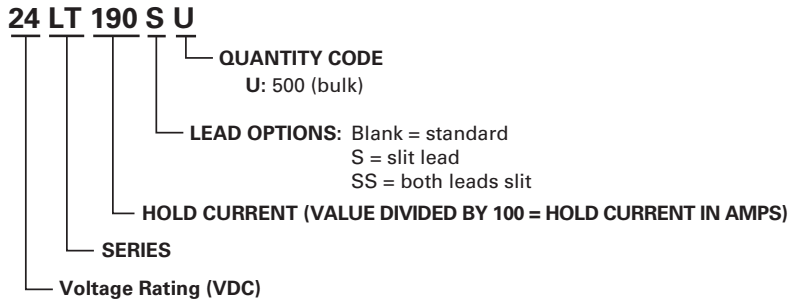

Packaging

Part Number	Ordering Number	I _{hold} (A)	I _{hold} Code	Packaging Option	Quantity	Quantity & Packaging Codes
15LT070	15LT070U	0.7	070	Bulk	500	U
15LT070S	15LT070SU	0.7	070	Bulk	500	U
24LT100	24LT100U	1.0	100	Bulk	500	U
24LT100S	24LT100SU	1.0	100	Bulk	500	U
24LT100SS	24LT100SSU	1.0	100	Bulk	500	U
24LT180	24LT180U	1.8	180	Bulk	500	U
24LT180S	24LT180SU	1.8	180	Bulk	500	U
24LT180SS	24LT180SSU	1.8	180	Bulk	500	U
24LT190	24LT190U	1.9	190	Bulk	500	U
24LT190S	24LT190SU	1.9	190	Bulk	500	U
24LT260	24LT260U	2.6	260	Bulk	500	U
24LT300	24LT300U	3.0	300	Bulk	500	U
24LT310	24LT310U	3.1	310	Bulk	500	U
24LT340	24LT340U	3.4	340	Bulk	500	U

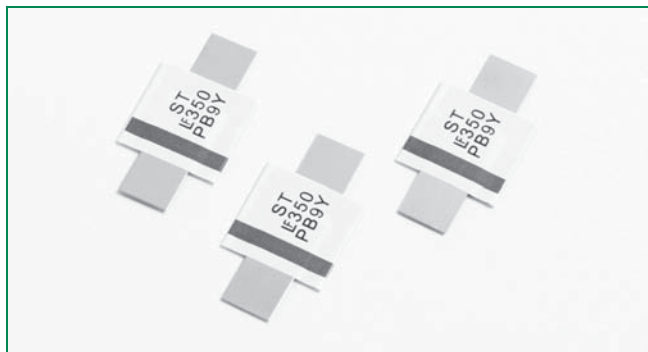

Description

The new ST Series device provides reliable, noncycling protection against overcharging and short circuits events for rechargeable battery cells where resettable protection is desired.



Features

- RoHS compliant and lead-free
- Weldable Nickel terminals
- Low resistance
- Provides overcurrent protection at 125°C trip temperature



Applications

- Rechargeable battery cell protection

Agency Approvals

AGENCY	AGENCY FILE NUMBER
	E183209
	R50119583

Electrical Characteristics

Part Number	I _{hold} (A)	I _{trip} (A)	V _{max} (Vdc)	I _{max} (A)	P _{d max.} (W)	Maximum Time To Trip		Resistance			Agency Approvals	
						Current (A)	Time (Sec.)	R _{min} (Ω)	R _{typ} (Ω)	R _{1max} (Ω)		
15ST120	1.2	2.7	15	100	1.2	6.00	5.00	0.085	0.160	0.220	X	X
15ST120S	1.2	2.7	15	100	1.2	6.00	5.00	0.085	0.160	0.220	X	X
15ST175	1.75	3.8	15	100	2.5	8.75	5.00	0.050	0.090	0.120	X	X
15ST175S	1.75	3.8	15	100	2.5	8.75	5.00	0.050	0.090	0.120	X	X
30ST200	2.00	4.4	30	100	1.9	10.00	4.00	0.030	0.060	0.100	X	X
30ST350	3.50	6.3	30	100	2.5	20.00	3.00	0.017	0.031	0.050	X	X
30ST420	4.20	7.6	30	100	2.9	20.00	6.00	0.012	0.024	0.040	X	X

Items with S at end of part number identify items with slit lead option. See Dimension Drawing and Part Ordering Number System sections of this document for more information.

I_{hold} = Hold current: maximum current device will pass without tripping in 20°C still air.

I_{trip} = Trip current: minimum current at which the device will trip in 20°C still air.

V_{max} = Maximum voltage device can withstand without damage at rated current (I_{max})

I_{max} = Maximum fault current device can withstand without damage at rated voltage (V_{max})

P_d = Power dissipated from device when in the tripped state at 20°C still air.

R_{min} = Minimum resistance of device in initial (un-soldered) state.

R_{typ} = Typical resistance of device in initial (un-soldered) state.

R_{1max} = Maximum resistance of device at 20°C measured one hour after tripping or reflow soldering of 260°C for 20 sec.

Caution: Operation beyond the specified rating may result in damage and possible arcing and flame.

Temperature Derating

Part Number	Ambient Operation Temperature								
	-40°C	-20°C	0°C	23°C	40°C	50°C	60°C	70°C	85°C
	Hold Current (A)								
15ST120	1.90	1.70	1.50	1.20	1.00	0.90	0.80	0.70	0.50
15ST120S	1.90	1.70	1.50	1.20	1.00	0.90	0.80	0.70	0.50
15ST175	2.50	2.30	2.00	1.75	1.50	1.30	1.20	1.10	0.90
15ST175S	2.50	2.30	2.00	1.75	1.50	1.30	1.20	1.10	0.90
30ST200	3.20	2.80	2.50	2.00	1.70	1.60	1.40	1.20	0.90
30ST350	5.40	4.80	4.30	3.50	3.00	2.80	2.50	2.20	1.70
30ST420	6.40	5.70	5.10	4.20	3.60	3.30	3.00	2.60	2.10

Average Time Current Curves

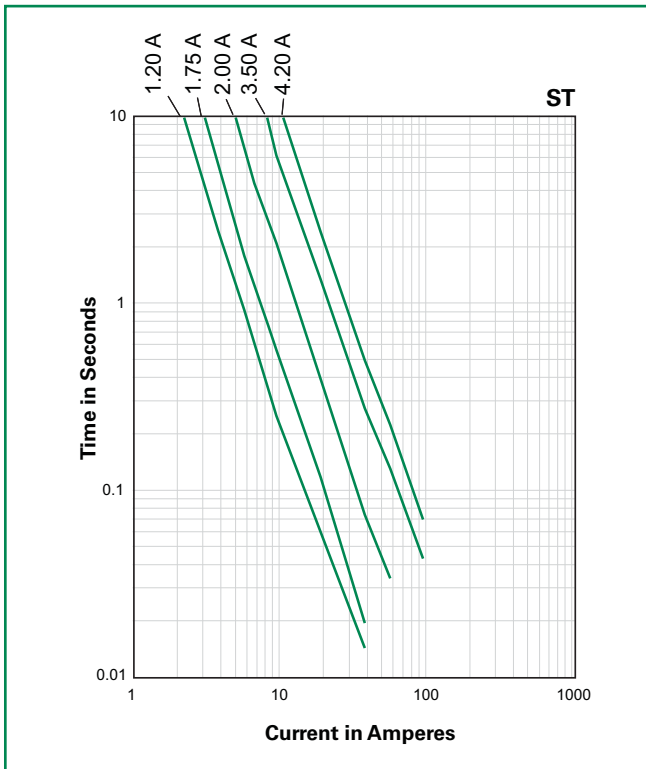

Temperature Derating Curve

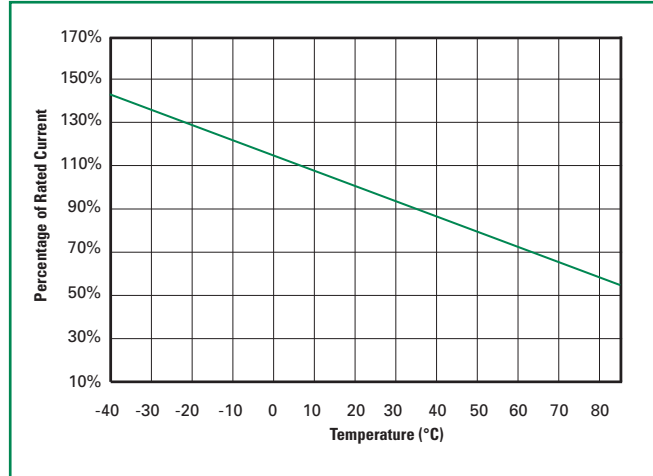

The average time current curves and Temperature Derating curve performance is affected by a number of variables, and these curves provided as guidance only. Customer must verify the performance in their application.

Physical Specifications

Lead Material	0.13mm nominal thickness, quarter-hard Nickel
Insulating Material	Polyester tape

Environmental Specifications

Operating/Storage Temperature	-40°C to +85°C
Maximum Device Surface Temperature in Tripped State	125°C
Passive Aging	+70°C, 1000 hours -/+5% typical resistance change
Humidity Aging	+85°C, 85% R.H., 7 days, -/+5% typical resistance change
Vibration	MIL-STD-883C, Condition A, No change

Dimensions

Figure 1

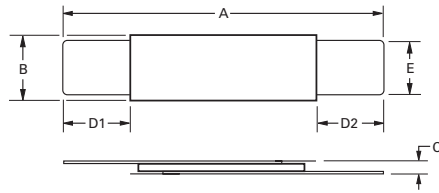
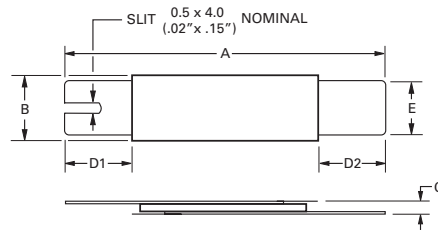

Figure 2

(Items with S at end of part number)



Part Number	Fig.	A				B				C				D1		D2		E			
		Inches		mm		Inches		mm		Inches		mm		Inches	mm	Inches	mm	Inches		mm	
		Min.	Max.	Min.	Max.	Min.	Max.	Min.	Max.	Min.	Max.	Min.	Max.	Min.	Min.	Min.	Min.	Min.	Max.	Min.	Max.
15ST120	1	0.78	0.87	19.9	22.1	0.19	0.20	4.9	5.2	0.02	0.04	0.6	1.0	0.22	5.5	0.22	5.5	0.01	0.22	3.9	4.1
15ST120S	2	0.78	0.87	19.9	22.1	0.19	0.20	4.9	5.2	0.02	0.04	0.6	1.0	0.22	5.5	0.22	5.5	0.01	0.22	3.9	4.1
15ST175	1	0.82	0.91	20.9	23.1	0.19	0.20	4.9	5.2	0.02	0.04	0.6	1.0	0.16	4.1	0.16	4.1	0.01	0.16	3.9	4.1
15ST175S	2	0.82	0.91	20.9	23.1	0.19	0.20	4.9	5.2	0.02	0.04	0.6	1.0	0.16	4.1	0.16	4.1	0.01	0.16	3.8	4.2
30ST200	1	0.84	0.92	21.3	23.4	0.40	0.43	10.2	11.0	0.02	0.04	0.5	1.1	0.20	5.0	0.20	5.0	0.19	0.21	4.8	5.4
30ST350	1	1.12	1.25	28.4	31.8	0.51	0.53	13.0	13.5	0.02	0.04	0.5	1.1	0.25	6.3	0.25	6.3	0.24	0.26	6.0	6.6
30ST420	1	1.20	1.28	30.6	32.4	0.51	0.54	12.9	13.6	0.02	0.04	0.5	1.1	0.20	5.0	0.20	5.0	0.24	0.26	6.0	6.7

Part Marking System

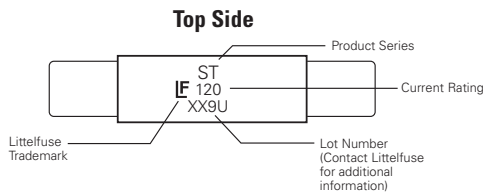

ST Series

Part Ordering Number System

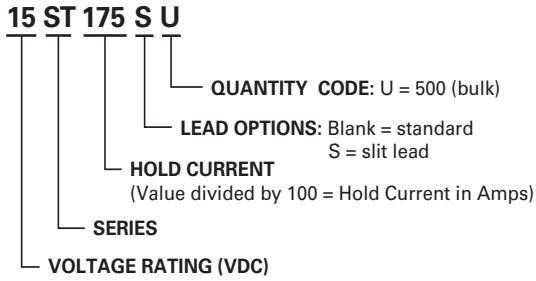

Packaging

Part Number	Ordering Number	I_{hold} (A)	I_{hold} Code	Packaging Option	Quantity	Quantity & Packaging Codes
15ST120	15ST120U	1.2	120	Bulk	500	U
15ST120S	15ST120SU	1.2	120	Bulk	500	U
15ST175	15ST175U	1.75	175	Bulk	500	U
15ST175S	15ST175SU	1.75	175	Bulk	500	U
30ST200	STD200U	2.00	200	Bulk	500	U
30ST350	STD350U	3.50	350	Bulk	500	U
30ST420	STD420U	4.20	420	Bulk	500	U

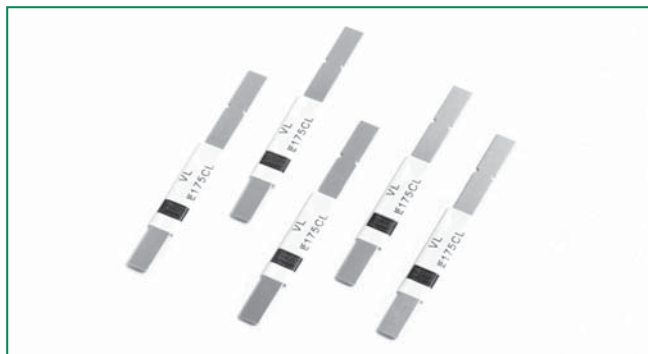

Description

The new VL Series device provides reliable, noncycling protection against overcharging and short circuits events for rechargeable battery cells where resettable protection is desired.



Features

- RoHS compliant and lead-free
- Compact design saves board space
- Weldable Nickel terminals
- Low resistance
- Slim, low profile design



Applications

- Rechargeable battery cell protection

Agency Approvals

AGENCY	AGENCY FILE NUMBER
	E183209
	R50119583

Electrical Characteristics

Part Number	I_{hold} (A)	I_{trip} (A)	V_{max} (Vdc)	I_{max} (A)	P_d^{max} (W)	Maximum Time To Trip		Resistance			Agency Approvals	
						Current (A)	Time (Sec.)	R_{min} (Ω)	R_{typ} (Ω)	R_{1max} (Ω)		
12VL170	1.70	4.10	12	100	1.4	8.50	5.00	0.018	0.032	0.064	X	X
12VL175L	1.75	4.20	12	100	1.4	8.75	5.00	0.017	0.031	0.062	X	X
12VL175XL	1.75	4.20	12	100	1.4	8.75	5.00	0.017	0.031	0.062	X	X
12VL230	2.30	5.00	12	100	1.5	10.00	5.00	0.012	0.018	0.036	X	X

I_{hold} = Hold current: maximum current device will pass without tripping in 20°C still air.

I_{trip} = Trip current: minimum current at which the device will trip in 20°C still air.

V_{max} = Maximum voltage device can withstand without damage at rated current (I_{max})

I_{max} = Maximum fault current device can withstand without damage at rated voltage (V_{max})

P_d = Power dissipated from device when in the tripped state at 20°C still air.

R_{min} = Minimum resistance of device in initial (un-soldered) state.

R_{typ} = Typical resistance of device in initial (un-soldered) state.

R_{1max} = Maximum resistance of device at 20°C measured one hour after tripping or reflow soldering of 260°C for 20 sec.

Caution: Operation beyond the specified rating may result in damage and possible arcing and flame.

Temperature Derating

Part Number	Ambient Operation Temperature							
	-40°C	-20°C	0°C	25°C	40°C	50°C	60°C	70°C
12VL170	3.5	2.9	2.4	1.70	1.2	1.0	0.7	0.3
12VL175L	3.5	2.9	2.4	1.75	1.3	1.0	0.8	0.3
12VL175XL	3.5	2.9	2.4	1.75	1.3	1.0	0.8	0.3
12VL230	5.0	4.2	3.4	2.30	1.7	1.3	0.9	0.4

Average Time Current Curves

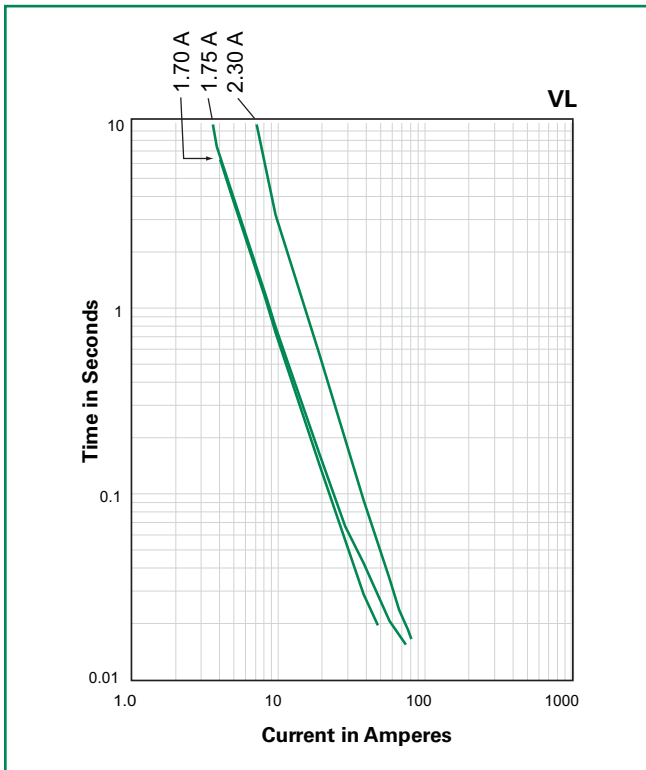

Temperature Derating Curve

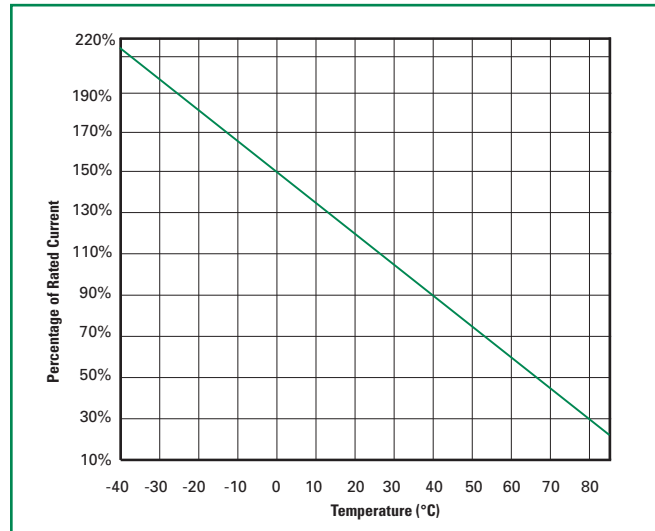

The average time current curves and Temperature Derating curve performance is affected by a number of variables, and these curves provided as guidance only. Customer must verify the performance in their application.

Physical Specifications

Terminal Material	0.13mm nominal thickness, quarter-hard Nickel
Insulating Material	Polyester tape

Environmental Specifications

Operating/Storage Temperature	-40°C to +85°C
Passive Aging	+60°C, 1000 hours -/+20% typical resistance change -40°C, 1000 hours -/+5% typical resistance change
Humidity Aging	+60°C, 95% R.H., 1000 hours, -/+10% typical resistance change
Thermal Shock	MIL-STD-202F, Method 107G, +85°C to -40°C 10 times -/+5% typical resistance change
Vibration	MIL-STD-883C, Method 2026, No change

Dimensions

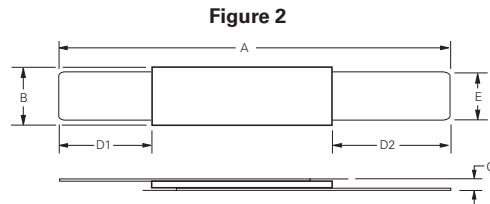
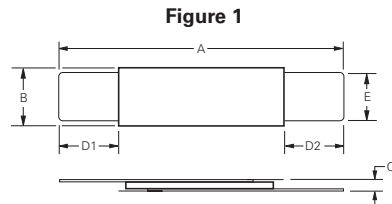

Part Number	Figure	A		B				C		D1		D2		E											
		Inches	mm	Inches	mm	Inches	mm	Inches	mm	Inches	mm	Inches	mm	Inches	mm	Inches	mm								
		Min.	Max.	Min.	Max.	Min.	Max.	Min.	Max.	Min.	Max.	Min.	Max.	Min.	Max.	Min.	Max.	Min.	Max.						
12VL170	1	0.82	0.91	20.80	23.20	0.14	0.15	3.50	3.90	--	0.03	--	0.80	0.18	0.26	4.50	6.50	0.18	0.26	4.50	6.50	0.09	0.10	2.40	2.60
12VL175L	2	1.15	1.25	29.30	31.70	0.11	0.13	2.90	3.30	--	0.03	--	0.80	0.20	0.27	5.20	6.80	0.39	0.49	10.00	12.50	0.09	0.10	2.40	2.60
12VL175XL	2	1.00	1.11	25.50	28.20	0.14	0.15	3.50	3.90	--	0.03	--	0.80	0.34	0.41	8.70	10.30	0.22	0.29	5.70	7.30	0.09	0.10	2.40	2.60
12VL230	1	0.82	0.91	20.90	23.10	0.19	0.21	4.90	5.30	--	0.03	--	0.80	0.16	0.23	4.10	5.80	0.16	0.23	4.10	5.80	0.15	0.16	3.90	4.10

Part Marking System

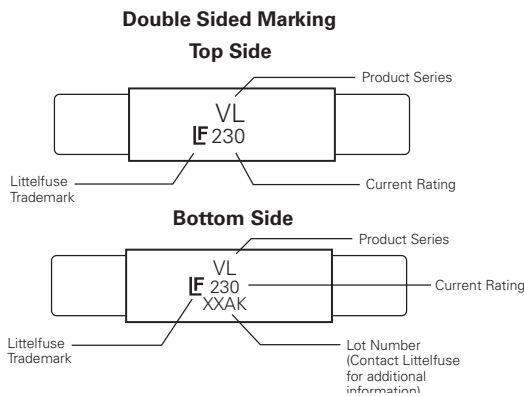

VL Series

Part Ordering Number System

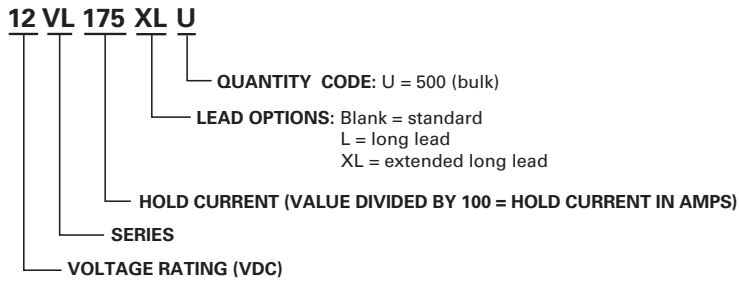

Packaging

Part Number	Ordering Number	I_{hold} (A)	I_{hold} Codes	Packaging Option	Quantity	Quantity & Packaging Codes
12VL170	12VL170U	1.70	170	Bulk	500	U
12VL175L	12VL175LU	1.75	175	Bulk	500	U
12VL175XL	12VL175XLU	1.75	175	Bulk	500	U
12VL230	12VL230U	2.30	230	Bulk	500	U



Description

The new VT Series device provides reliable, noncycling protection against overcharging and short circuits events for rechargeable battery cells where resettable protection is desired.



Features

- RoHS compliant and lead-free
- Weldable Nickel terminals
- Slim, low profile design
- Compact design saves board space
- Low resistance



Applications

- Rechargeable battery cell protection
 - Mobile phones
 - Laptop computers

Agency Approvals

AGENCY	AGENCY FILE NUMBER
	E183209
	R50119583

Electrical Characteristics

Part Number	I _{hold} (A)	I _{trip} (A)	V _{max} (Vdc)	I _{max} (A)	P _{d max.} (W)	Maximum Time To Trip		Resistance			Agency Approvals	
						Current (A)	Time (Sec.)	R _{min} (Ω)	R _{typ} (Ω)	R _{1max} (Ω)		
16VT170	1.70	3.40	16	100	1.4	8.50	3.00	0.030	0.052	0.105	X	X
16VT170XS	1.70	3.40	16	100	1.4	8.50	3.00	0.030	0.052	0.105	X	X
16VT175	1.75	3.80	16	100	1.4	9.00	3.00	0.025	0.045	0.090	X	X
16VT175S	1.75	3.80	16	100	1.4	9.00	3.00	0.025	0.045	0.090	X	X
16VT175L	1.75	3.80	16	100	1.4	9.00	3.00	0.025	0.045	0.090	X	X
16VT175XL	1.75	3.80	16	100	1.4	8.75	5.00	0.029	0.051	0.102	X	X
16VT175EL	1.75	3.60	16	100	1.4	8.75	5.00	0.029	0.051	0.102	X	X
16VT175NEL	1.75	3.60	16	100	1.4	8.75	5.00	0.029	0.051	0.102	X	X
16VT200	2.00	4.50	16	100	1.5	10.00	4.00	0.021	0.039	0.080	X	X
16VT200S	2.00	4.50	16	100	1.5	10.00	4.00	0.021	0.039	0.080	X	X
16VT200UL	2.00	4.70	16	100	1.5	10.00	5.00	0.022	0.039	0.076	X	X
16VT210	2.10	4.70	16	100	1.5	10.00	5.00	0.018	0.030	0.060	X	X
16VT210S	2.10	4.70	16	100	1.5	10.00	5.00	0.018	0.030	0.060	X	X
16VT210SS	2.10	4.70	16	100	1.5	10.00	5.00	0.018	0.030	0.060	X	X
16VT210L	2.10	4.70	16	100	1.5	10.00	5.00	0.018	0.030	0.060	X	X
16VT210NL	2.10	4.70	16	100	1.5	10.00	5.00	0.018	0.035	0.065	X	X
16VT210UL	2.10	4.70	16	100	1.5	10.00	5.00	0.018	0.035	0.065	X	X
16VT240	2.40	5.40	16	100	1.5	12.00	4.00	0.015	0.026	0.052	X	X

I_{hold} = Hold current: maximum current device will pass without tripping in 20°C still air.
 I_{trip} = Trip current: minimum current at which the device will trip in 20°C still air.
 V_{max} = Maximum voltage device can withstand without damage at rated current (I_{max})
 I_{max} = Maximum fault current device can withstand without damage at rated voltage (V_{max})
 P_d = Power dissipated from device when in the tripped state at 20°C still air.
 R_{min} = Minimum resistance of device in initial (un-soldered) state.

R_{typ} = Typical resistance of device in initial (un-soldered) state.
 R_{1max} = Maximum resistance of device at 20°C measured one hour after tripping or reflow soldering of 260°C for 20 sec.

Caution: Operation beyond the specified rating may result in damage and possible arcing and flame.

Temperature Derating

Part Number	Ambient Operation Temperature								
	-40°C	-20°C	0°C	23°C	40°C	50°C	60°C	70°C	85°C
16VT170	3.20	2.70	2.20	1.70	1.30	1.00	0.80	0.50	0.10
16VT170XS	3.20	2.70	2.20	1.70	1.30	1.00	0.80	0.50	0.10
16VT175	3.20	2.70	2.20	1.75	1.30	1.00	0.80	0.50	0.10
16VT175S	3.20	2.70	2.20	1.75	1.30	1.00	0.80	0.50	0.10
16VT175L	3.20	2.70	2.20	1.75	1.30	1.00	0.80	0.50	0.10
16VT175XL	3.20	2.70	2.20	1.75	1.30	1.00	0.80	0.50	0.10
16VT175EL	3.20	2.70	2.20	1.75	1.30	1.00	0.80	0.50	0.10
16VT175NEL	3.20	2.70	2.20	1.75	1.30	1.00	0.80	0.50	0.10
16VT200	3.70	3.20	2.60	2.00	1.50	1.20	0.90	0.50	0.10
16VT200S	3.70	3.20	2.60	2.00	1.50	1.20	0.90	0.50	0.10
16VT200UL	3.70	3.20	2.60	2.00	1.50	1.20	0.90	0.50	0.10
16VT210	4.10	3.50	2.90	2.10	1.60	1.30	1.00	0.70	0.10
16VT210S	4.10	3.50	2.90	2.10	1.60	1.30	1.00	0.70	0.10
16VT210SS	4.10	3.50	2.90	2.10	1.60	1.30	1.00	0.70	0.10
16VT210L	4.10	3.50	2.90	2.10	1.60	1.30	1.00	0.70	0.10
16VT210NL	4.10	3.50	2.90	2.10	1.60	1.30	1.00	0.70	0.10
16VT210UL	4.10	3.50	2.90	2.10	1.60	1.30	1.00	0.70	0.10
16VT240	4.40	3.70	3.10	2.40	1.80	1.50	1.20	0.90	0.10

Average Time Current Curves

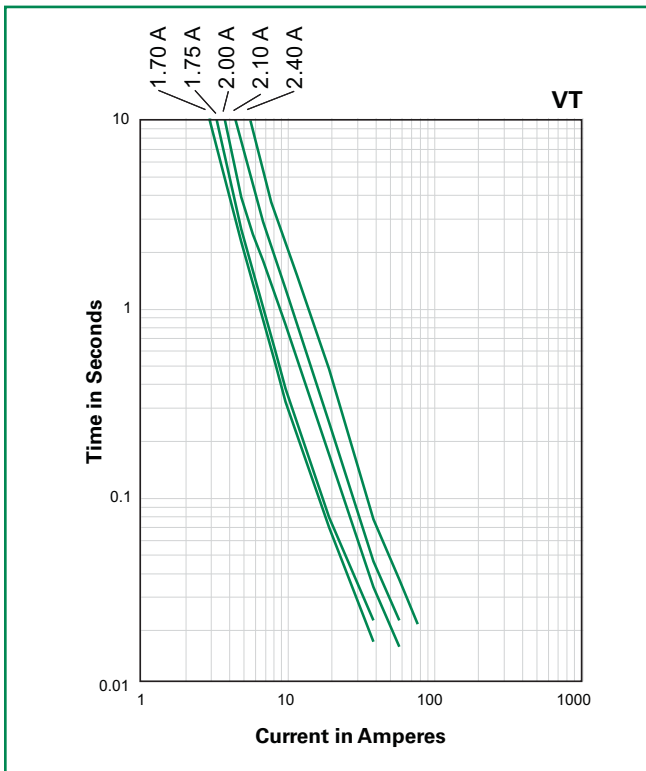

Temperature Derating Curve

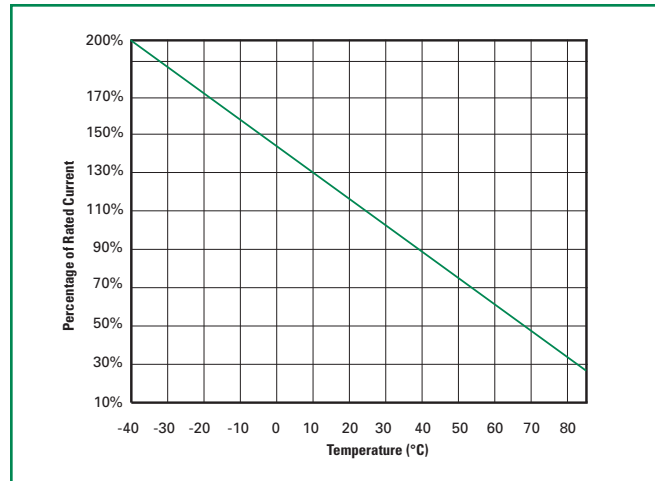

The average time current curves and Temperature Derating curve performance is affected by a number of variables, and these curves provided as guidance only. Customer must verify the performance in their application.

Physical Specifications

Terminal Material	0.13mm nominal thickness, quarter-hard Nickel
Insulating Material	Polyester tape

Part Marking System

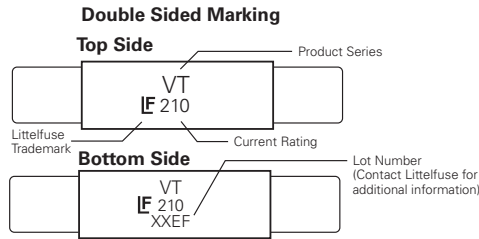

Environmental Specifications

Operating/Storage Temperature	-40°C to +85°C
Passive Aging	+70°C, 1000 hours, +/-10% typical resistance change
Humidity Aging	+85°C, 85% R.H., 7 days, +/-5% typical resistance change
Thermal Shock	MIL-STD-202F, Method 107G, +85°C/-40°C 20 times, -30% typical resistance change
Vibration	MIL-STD-883C, Method 2007.1, Condition A, No change

Dimensions

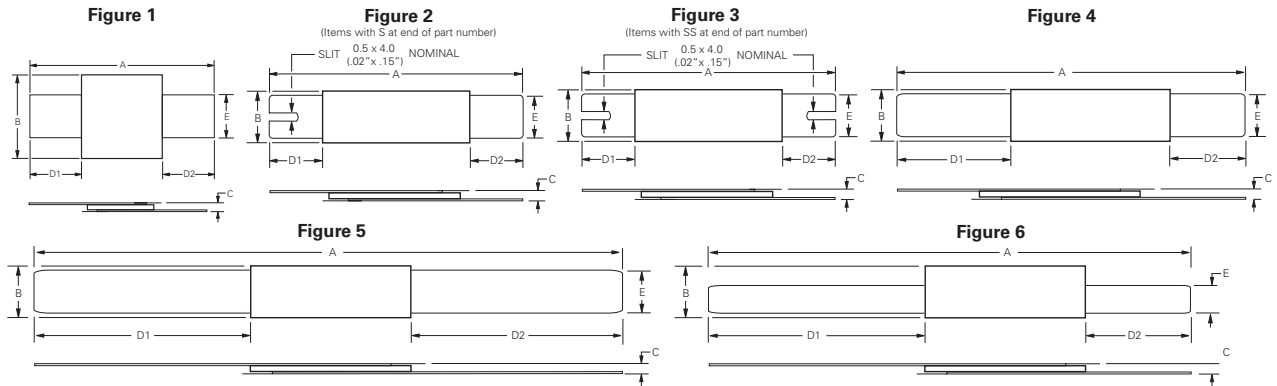

Part Number	Figure	A		B		C		D1		D2		E													
		Inches	mm	Inches	mm	Inches	mm	Inches	mm	Inches	mm	Inches	mm												
		Min.	Max.	Min.	Max.	Min.	Max.	Min.	Max.	Min.	Max.	Min.	Max.	Min.	Max.										
16VT170	1	0.61	0.69	15.40	17.50	0.28	0.29	7.00	7.40	0.02	0.03	0.50	0.80	0.16	0.24	4.0	6.2	0.16	0.24	4.0	6.2	0.15	0.16	3.90	4.10
16VT170XS	2	0.82	0.90	20.90	22.90	0.19	0.21	4.90	5.30	0.02	0.03	0.50	0.80	0.16	0.34	4.0	8.6	0.16	0.34	4.0	8.6	0.15	0.16	3.90	4.10
16VT175	1	0.82	0.87	20.90	22.20	0.14	0.15	3.50	3.80	0.02	0.03	0.50	0.80	0.16	0.20	4.0	5.0	0.16	0.20	4.0	5.0	0.11	0.12	2.90	3.10
16VT175S	2	0.82	0.87	20.90	22.20	0.14	0.15	3.50	3.80	0.02	0.03	0.50	0.80	0.16	0.20	4.0	5.0	0.16	0.20	4.0	5.0	0.11	0.12	2.90	3.10
16VT175L	1	1.02	1.10	26.00	28.00	0.14	0.15	3.50	3.80	0.02	0.03	0.50	0.80	0.24	-	6.0	-	0.24	-	6.0	-	0.11	0.12	2.90	3.10
16VT175XL	4	1.00	1.11	25.50	28.20	0.14	0.15	3.50	3.90	0.02	0.03	0.50	0.80	0.34	0.41	8.7	10.3	0.22	0.29	5.7	7.3	0.09	0.10	2.40	2.60
16VT175EL	6	1.53	1.62	38.80	41.20	0.14	0.15	3.50	3.90	0.02	0.03	0.60	0.80	0.74	0.80	18.7	20.3	0.34	0.41	8.7	10.3	0.09	0.10	2.40	2.60
16VT175NEL	6	1.53	1.62	38.80	41.20	0.11	0.13	2.90	3.30	0.02	0.03	0.60	0.80	0.79	0.87	20.0	22.0	0.20	0.27	5.2	6.8	0.09	0.10	2.40	2.60
16VT200	1	0.82	0.91	20.90	23.10	0.15	0.17	3.80	4.30	0.02	0.03	0.60	0.70	0.16	0.20	4.0	5.0	0.16	0.20	4.0	5.0	0.11	0.12	2.90	3.10
16VT200S	2	0.82	0.91	20.90	23.10	0.15	0.17	3.80	4.30	0.02	0.03	0.60	0.70	0.16	0.20	4.0	5.0	0.16	0.20	4.0	5.0	0.11	0.12	2.90	3.10
16VT200UL	4	1.42	1.54	36.00	39.00	0.16	0.17	4.10	4.30	0.02	0.03	0.50	0.80	0.15	0.21	3.9	5.3	0.78	0.85	19.7	21.5	0.11	0.12	2.90	3.10
16VT210	1	0.82	0.91	20.90	23.10	0.19	0.21	4.90	5.30	0.02	0.03	0.60	0.80	0.16	0.23	4.1	5.8	0.16	0.23	4.1	5.8	0.15	0.16	3.90	4.10
16VT210S	2	0.82	0.91	20.90	23.10	0.19	0.21	4.90	5.30	0.02	0.03	0.60	0.80	0.16	0.23	4.1	5.8	0.16	0.23	4.1	5.8	0.15	0.16	3.90	4.10
16VT210SS	3	0.82	0.91	20.90	23.10	0.19	0.21	4.90	5.30	0.02	0.03	0.60	0.80	0.16	0.23	4.1	5.8	0.16	0.23	4.1	5.8	0.15	0.16	3.90	4.10
16VT210L	1	0.94	1.02	24.00	26.00	0.19	0.21	4.90	5.30	0.02	0.03	0.60	0.80	0.20	0.28	5.0	7.1	0.20	0.28	5.0	7.1	0.15	0.16	3.90	4.10
16VT210NL	5	2.78	2.81	70.50	71.50	0.15	0.17	3.80	4.30	0.02	0.03	0.60	0.80	0.98	-	25.0	-	0.98	-	25.0	-	0.11	0.12	2.90	3.10
16VT210UL	5	2.78	2.81	70.50	71.50	0.19	0.21	4.90	5.30	0.02	0.03	0.60	0.80	1.12	-	28.5	-	1.12	-	28.5	-	0.15	0.16	3.90	4.10
16VT240	1	0.95	1.03	24.20	26.20	0.19	0.21	4.90	5.30	0.02	0.03	0.60	0.80	0.20	0.22	5.0	5.7	0.20	0.22	5.0	5.7	0.15	0.16	3.90	4.10

Part Ordering Number System

16 VT 175 NEL U

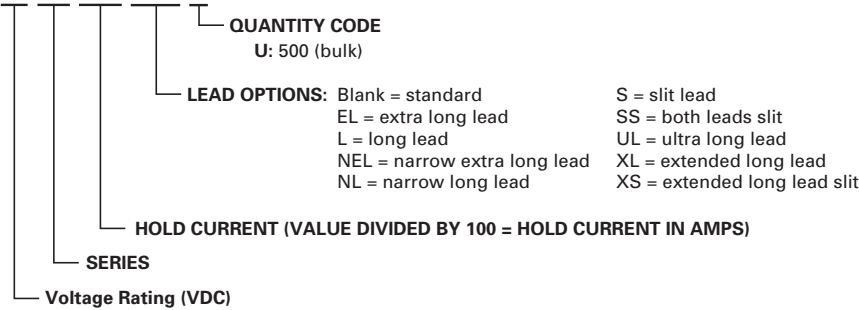

Packaging

Part Number	Ordering Number	I _{hold} (A)	I _{hold} Code	Packaging Option	Quantity	Quantity & Packaging Codes
16VT170	16VT170U	1.70	170	Bulk	500	U
16VT170XS	16VT170XSU	1.70	170	Bulk	500	U
16VT175	16VT175U	1.75	175	Bulk	500	U
16VT175S	16VT175SU	1.75	175	Bulk	500	U
16VT175L	16VT175LU	1.75	175	Bulk	500	U
16VT175XL	16VT175XLU	1.75	175	Bulk	500	U
16VT175EL	16VT175ELU	1.75	175	Bulk	500	U
16VT175NEL	16VT175NELU	1.75	175	Bulk	500	U
16VT200	16VT200U	2.00	200	Bulk	500	U
16VT200S	16VT200SU	2.00	200	Bulk	500	U
16VT200UL	16VT200ULU	2.00	200	Bulk	500	U
16VT210	16VT210U	2.10	210	Bulk	500	U
16VT210S	16VT210SU	2.10	210	Bulk	500	U
16VT210SS	16VT210SSU	2.10	210	Bulk	500	U
16VT210L	16VT210LU	2.10	210	Bulk	500	U
16VT210NL	16VT210NLU	2.10	210	Bulk	500	U
16VT210UL	16VT210ULU	2.10	210	Bulk	500	U
16VT240	16VT240U	2.40	240	Bulk	500	U



http://littelfuse.com

To assist you with your electronics design and selection processes, Littelfuse also offers:

Comprehensive Online Product Specs on Littelfuse.com—Featuring easy-to-use navigation, search and selection tools, as well as additional product details. You can rely on Littelfuse.com for instant answers and continuously up-to-date information.

Printed Product Catalogs—For offline and off-the-shelf convenience, our printed product catalogs include data sheets, selection tables and tutorials covering all of our core technologies. Contact your Littelfuse product representative or visit www.littelfuse.com/catalogs to check availability.

Circuit Protection Design Guides—Our application design center website, www.littelfuse.com/designcenter, offers a wealth of circuit protection guidance to help you select and apply the best circuit protection solution for your application.

As the world's #1 brand in circuit protection, Littelfuse offers a complete portfolio of circuit protection products. To request our catalogs, please contact your authorized Littelfuse product representative or visit our website at www.littelfuse.com/catalogs

Littelfuse offers several technologies to protect sensitive electronic circuits from excess current resulting from overloads, short circuits, power cross or ground faults. Our overcurrent protection product line includes:

Fuses Littelfuse offers the world's broadest range of fuse types and ratings, including cartridge, leaded, surface mount and thin film designs

PTCs Positive Temperature Coefficient thermistor technology provides resettable current-limiting protection



Littelfuse offers multiple technologies for overvoltage suppression and switching to protect sensitive electronic circuits from excessive voltage resulting from electrostatic discharge (ESD), load switching or lightning strikes. Our overvoltage protection product line includes:

Varistors Littelfuse offers surface mount Multi-Layer Varistors (MLVs) and industrial Metal Oxide Varistors (MOVs) to protect against transients

GDTs Gas Discharge Tubes (GDTs) to dissipate voltage through a contained plasma gas

Thyristors Littelfuse's solid state switches control the flow of current in a wide range of appliances, tools and equipment

SIDACTor® Devices Overvoltage protection specifically designed for telecom and datacom requirements

TVS Diodes Silicon transient voltage suppression (TVS) devices

SPAs Silicon Protection Arrays designed for analog and digital signal line protection

PulseGuard® ESD Suppressors Small, fast-acting Electrostatic Discharge (ESD) suppressors

