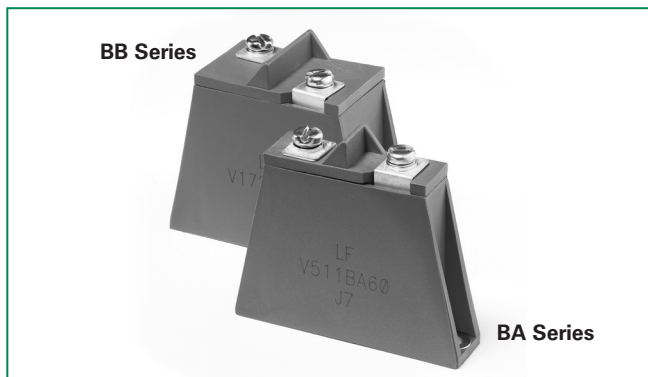

RoHS  **BA/BB Varistor Series**

Description

The BA and BB Series transient surge suppressors are heavy-duty industrial Metal-Oxide Varistors (MOVs) designed to provide surge protection for motor controls and power supplies used in oil-drilling, mining, transportation equipment and other heavy industrial AC line applications.

These UL- recognized varistors have similar package construction but differ in size and ratings. The BA models are rated from 130 to 880V_{M(AC)}. The BB models from 1100 to 2800V_{M(AC)}.

Both the BA and BB Series feature improved creep and strike capability to minimize breakdown along the package surface, a package design that provides complete electrical isolation of the disc subassembly, and rigid terminals to ensure secure wire contacts.

See BA/BB Series Device Ratings and Specifications Table for part number and brand information.

Agency Approvals

Agency	Agency File Number
	E320116 - for BA Series only.

Features

- RoHS compliant and Lead-free available
- High energy absorption capability W_{TM}
BA Series 3200J
BB Series 10,000J
- Wide operating voltage range $V_{M(AC)RMS}$
BA Series 130V to 880V
BB Series 1100V to 2800V
- Rigid terminals for secure wire contact
- Case design provides complete electrical isolation of disc subassembly
- Littelfuse largest packaged disc 60mm diameter
- No derating up to 85°C ambient

Absolute Maximum Ratings

• For ratings of individual members of a series, see Device Ratings and Specifications chart

Continuous	BA Series	BB Series	Units
Steady State Applied Voltage:			
AC Voltage Range ($V_{M(AC)RMS}$)	130 to 880	1100 to 2800	V
DC Voltage Range ($V_{M(DC)}$)	175 to 1150	1400 to 3500	V
Transients:			
Peak Pulse Current (I_{TM})			
For 8/20 μ s Current Wave (See Figure 2)	50,000 to 70,000	70,000	A
Single Pulse Energy Range			
For 2ms Current Squarewave (W_{TM})	450 to 3200	3800 to 10000	J
Operating Ambient Temperature Range (T_A)	-55 to +85	-55 to +85	°C
Storage Temperature Range (T_{STG})	-55 to +125	-55 to +125	°C
Temperature Coefficient (α^V) of Clamping Voltage (V_C) at Specified Test Current	<0.01	<0.01	%/°C
Hi-Pot Encapsulation (COATING Isolation Voltage Capability) (Dielectric must withstand indicated DC voltage for one minute per MIL-STD-202, Method 301)	5000	5000	V
COATING Insulation Resistance	1000	1000	M Ω

CAUTION: Stresses above those listed in "Absolute Maximum Ratings" may cause permanent damage to the device. This is a stress only rating and operation of the device at these or any other conditions above those indicated in the operational sections of this specification is not implied.

BA/BB Series Ratings & Specifications

Part Number	Maximum Rating (85°C)				Specifications (25°C)					
	Continuous		Transient		Varistor Voltage at 1mA DC Test Current			Maximum Clamping Volt V_C at 200A Current (8/20 μ s)	Typical Capacitance $f = 1$ MHz	
	V_{RMS}	V_{DC}	Energy (2ms)	Peak Current $8 \times 20\mu s$						
	$V_{M(AC)}$	$V_{M(DC)}$	W_{TM}	I_{TM}	Min	$V_{N(DC)}$	Max	V_C	C	
(V)	(V)	(J)	(A)	(V)	(V)	(V)	(V)	(pF)		
BA Series										
V131BA60	130	175	450	50000	184	200	228	340	20000	
V151BA60	150	200	530	50000	212	240	268	400	16000	
V251BA60	250	330	880	50000	354	390	429	620	10000	
V271BA60	275	369	950	50000	389	430	473	680	9000	
V321BA60	320	420	1100	50000	462	510	561	760	7500	
V421BA60	420	560	1500	70000	610	680	748	1060	6000	
V481BA60	480	640	1600	70000	670	750	825	1160	5500	
V511BA60	510	675	1800	70000	735	820	910	1300	5000	
V571BA60	575	730	2100	70000	805	910	1000	1420	4500	
V661BA60	660	850	2300	70000	940	1050	1160	1640	4000	
V751BA60	750	970	2600	70000	1080	1200	1320	1880	3500	
V881BA60	880	1150	3200	70000	1290	1500	1650	2340	2700	
BB Series										
V112BB60	1100	1400	3800	70000	1620	1800	2060	2940	2200	
V142BB60	1400	1750	5000	70000	2020	2200	2550	3600	1800	
V172BB60	1700	2150	6000	70000	2500	2700	3030	4300	1500	
V202BB60	2000	2500	7500	70000	2970	3300	3630	5200	1200	
V242BB60	2400	3000	8600	70000	3510	3900	4290	6200	1000	
V282BB60	2800	3500	10000	70000	4230	4700	5170	7400	800	

NOTE: Average power dissipation of transients not to exceed 2.5W. See Figures 3 and 4 for more information on power dissipation.

Power Dissipation Ratings

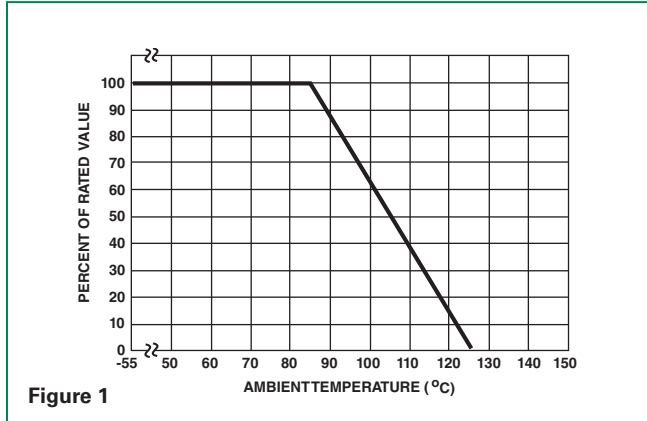

Figure 1

Should transients occur in rapid succession, the average power dissipation required is simply the energy (watt-seconds) per pulse times the number of pulses per second. The power so developed must be within the specifications shown on the Device Ratings and Characteristics Table for the specific device. Furthermore, the operating values need to be derated at high temperatures as shown in the above diagram. Because varistors can only dissipate a relatively small amount of average power they are, therefore, not suitable for repetitive applications that involve substantial amounts of average power dissipation.

Peak Pulse Current Test Waveform

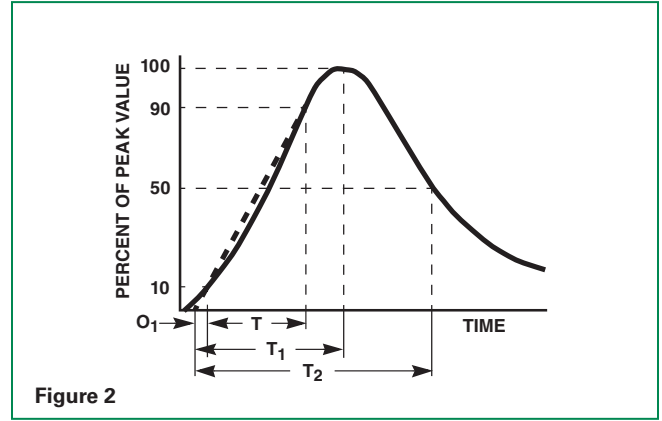

Figure 2

O_1 = Virtual Origin of Wave
 T = Time from 10% to 90% of Peak
 T_1 = Rise Time = $1.25 \times T$
 T_2 = Decay Time

Example - For an $8/20 \mu s$ Current Waveform:

$8 \mu s = T_1 = \text{Rise Time}$
 $20 \mu s = T_2 = \text{Decay Time}$

Stand by Power Dissipation vs Applied V_{RMS} at Varied Temperatures

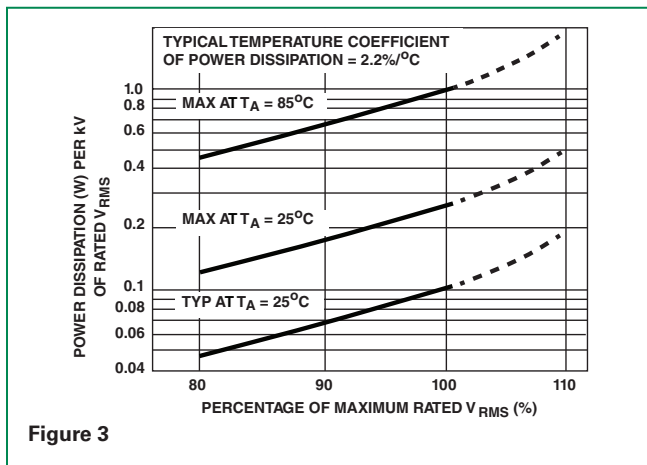

Figure 3

Typical Stability of Standby Power Dissipation at Rated V_{RMS} vs Time

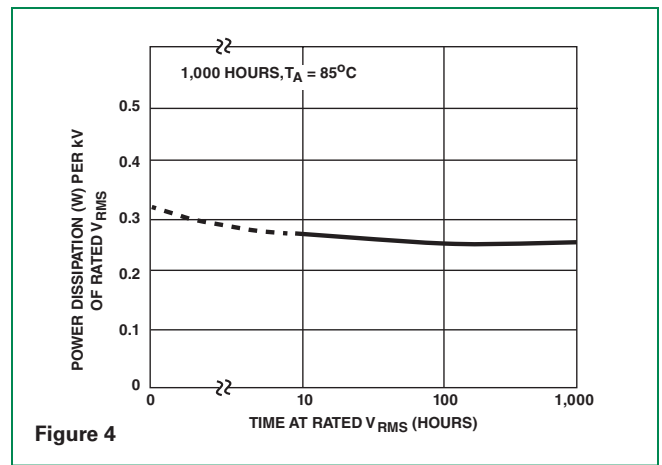

Figure 4

BA/BB Series

Maximum Clamping Voltage BA Series

V131BA60 - V881BA60

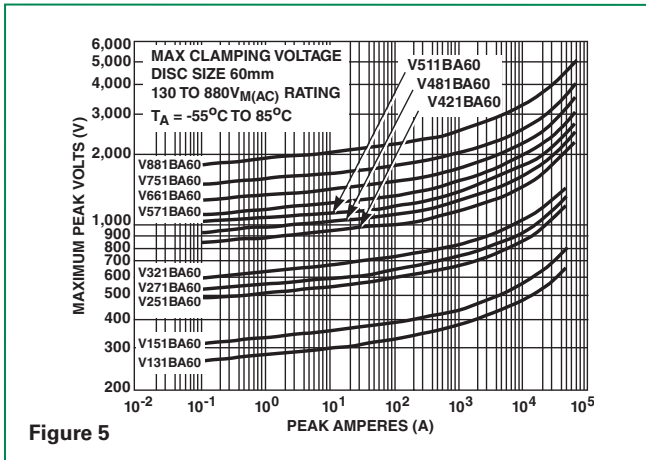

Figure 5

Maximum Clamping Voltage BB Series

V112BB60 - V282BB60

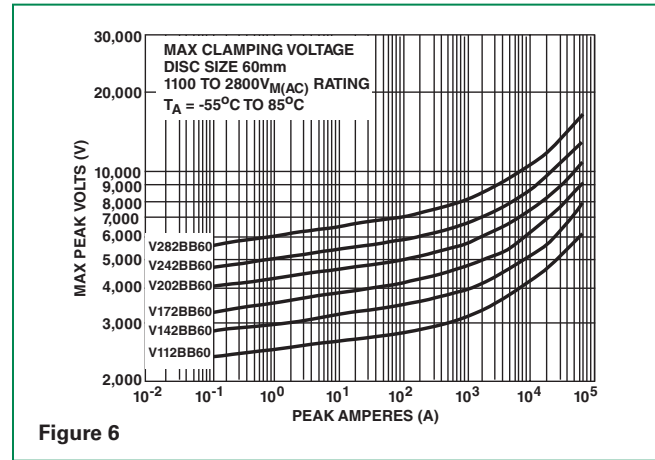

Figure 6

Repetitive Surge Capability BA Series

V131BA60 - V321BA60

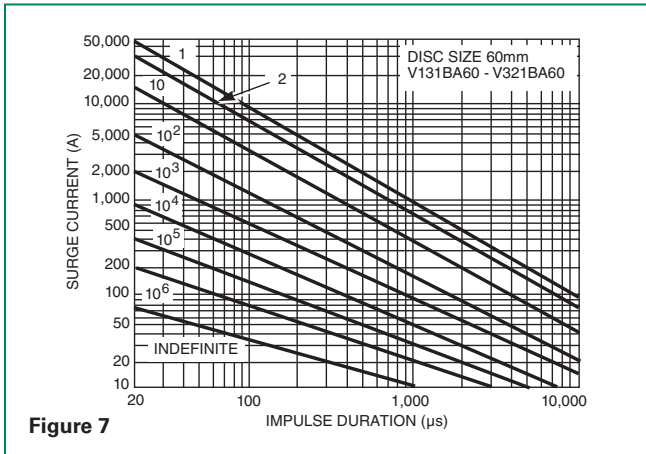

Figure 7

Repetitive Surge Capability BB Series

V421BA60 - V282BB60

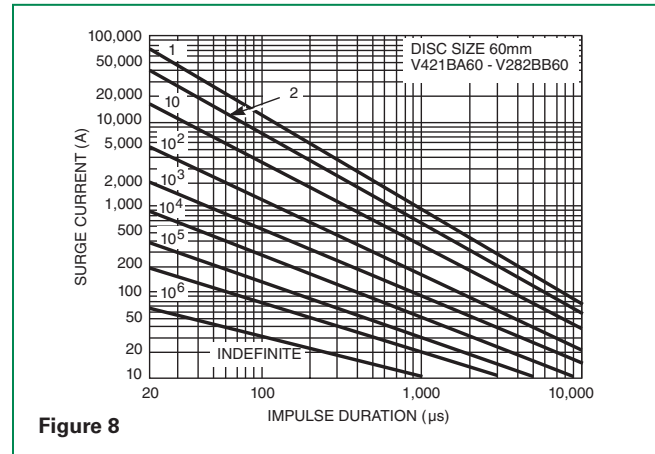

Figure 8

NOTE: If pulse ratings are exceeded, a shift of $V_{CL}(DC)$ (at specified current) of more than +/-10% could result. This type of shift, which normally results in a decrease of $V_{CL}(DC)$, may result in the device not meeting the original published specifications, but it does not prevent the device from continuing to function, and to provide ample protection.

Physical Specifications

Lead Material	BA / BB – Copper with Tin Plating
Insulating Material	Cured, flame retardant epoxy polymer meets UL94V-0 requirements.
Device Labeling	Marked with LF, Part Number and Date code

Environmental Specifications

Operating/Storage Temperature	-55°C to +85°C/ -55°C to +125°C
Humidity Aging	+85°C, 85% RH, 1000 hours +/- 5% typical resistance change
Thermal Shock	+85°C to -40°C 10 times +/- 5% typical resistance change
Solvent Resistance	MIL-STD-202, Method 215F
Moisture Sensitivity	Level 1, J-STD-020C

Dimensions

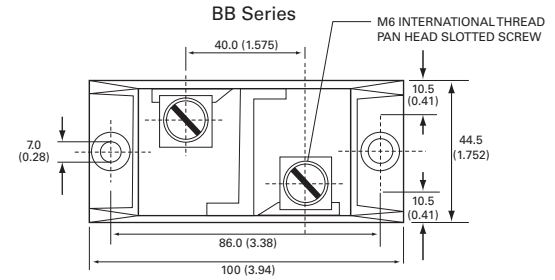
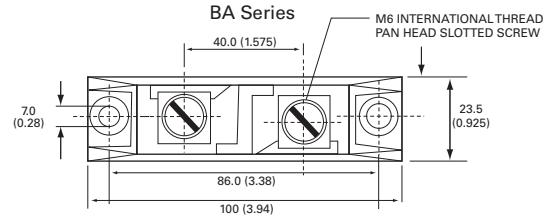
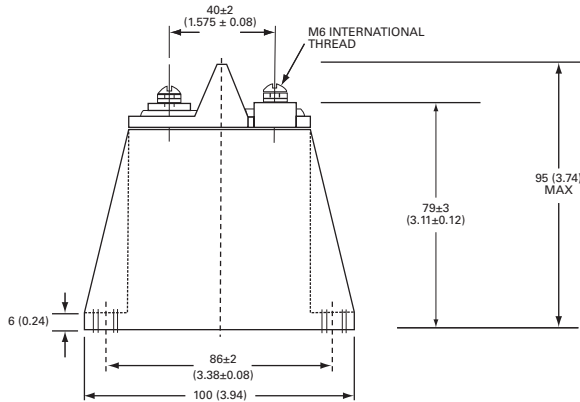

Notes:
Typical weight: BA Series:250g and BB Series: 600g
Dimensions are in mm; inches in parentheses for reference only.

Part Numbering System

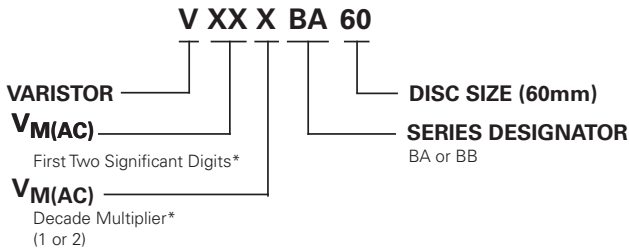

*Refer to Rating & Specifications table
Examples:
130 V_{M(AC)} = 131
2800 V_{M(AC)} = 282