



Analog Mixed Signal and Power Management

Packaging

Robust packaging is a key technology component of Analog Products.

Freescale puts solutions together in single packages to accommodate power, high voltages, communications, control, and protection features.

Environmentally Preferred Products (EPP) is also a key mandate for Freescale Analog products.

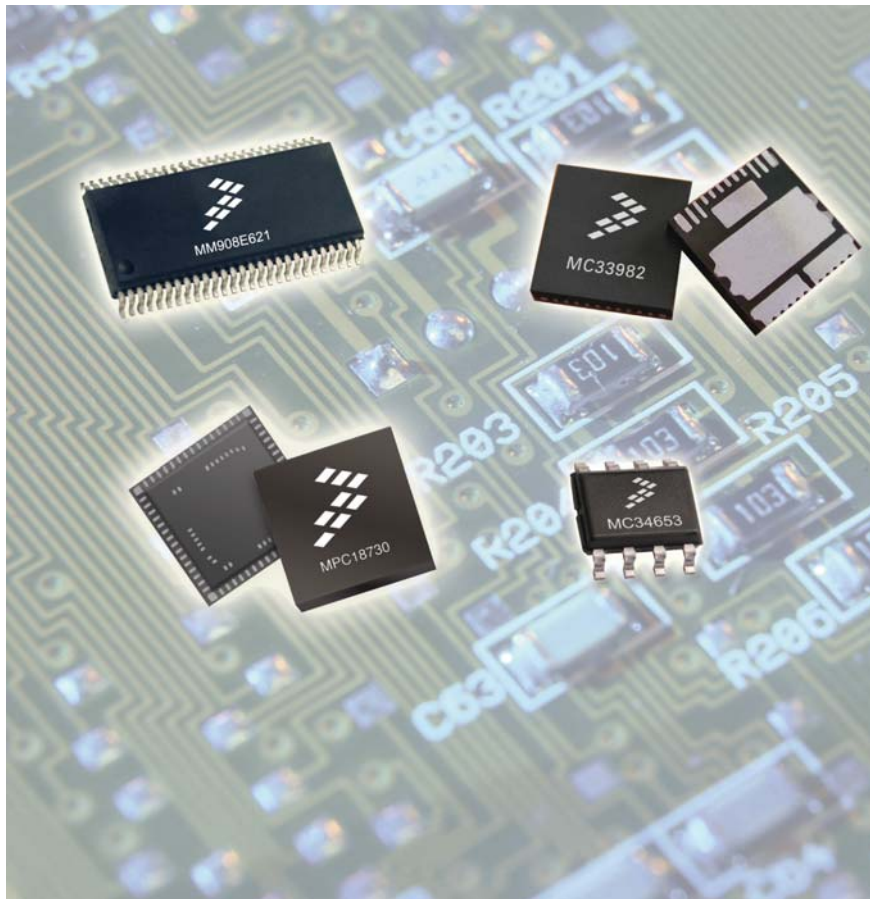

The Analog and Mixed Signal Products Division of Freescale has a long history of serving the commercial and automotive marketplace, and vast experience with the automotive industry's quality requirements / expectations.

We achieved QS9000 certification status in July 1998, TS16949 certification in 2004, and we use AEC-Q100 as the basis for our product stress test qualifications (products introduced prior to July 1998, which may have limited qualification or other data available). Data may be available on a fee-for-service basis.

Freescale Environmentally Preferred Products (EPP)

OVERVIEW:

Producing Environmentally Friendly Products

Delivering products that are free of hazardous substances is a Freescale priority. To that end, Freescale has a proactive Environmentally Preferred Products Program that assures it meets customer and legislative requirements, as well as Freescale's own standards, whichever is the most stringent, to reduce or eliminate the presence of lead (Pb) in its semiconductors. Historically, lead has been used in semiconductor packages to ensure an effective electrical connection is made when the semiconductor is integrated into the end product.

Freescale works closely with its customers and suppliers to ensure a smooth transition into compliance with current and pending requirements of the European Union, China, Japan and the USA regarding the use of hazardous substances in electronic equipment. In addition, Freescale closely monitors electronics industry standards for qualification of replacement technologies. Together, these efforts result in products that incorporate environmentally preferred materials and design features.

Freescale Environmental Product activities include RoHS (Restriction of Hazardous Substances), WEEE (Waste of Electrical and Electronic Equipment), and ELV (End of Life Vehicle) Directive compliance initiatives. Freescale restricts many hazardous substances from its products, but lead (Pb) is the primary focus.

EPP STRATEGY:

Freescale offers Environmentally Preferred products and packages. These products are RoHS compliant. Some are Pb-free, use Pb-free package terminations, or may be halogen free.

- EPP ball grid array (BGA) products use tin silver copper (SnAgCu) or SnAg (tin silver) solder balls.
- Termination finishes on EPP plated products use 100% matte tin (Sn) with a one hour, 150°C post-plate anneal. Some EPP products may use nickel palladium gold (NiPdAu) termination finishes.
- Environmentally Preferred Packaging Strategy:
 - RoHS compliant
 - MSL (Moisture Sensitivity Level) of 3 or better
 - Package Peak Temperature (PPT) per JEDEC J-STD-020C
 - Halogen-free mold compound
- Freescale intends to offer BGA products with SnPbAg solderballs for automotive and other RoHS exempt applications. The SnPbAg solderball products will use different part numbers from the Pb-free solderball products.

PB-FREE Termination Suffix:

This brochure uses various part number suffixes to identify products with Pb-free plating or balls. RoHS compliant products with these Pb-free terminations may contain other sources of Pb (RoHS exempt) in the packages. Freescale may also sell versions of some products that contain Pb which is not exempt from RoHS. Freescale will identify these products with separate part numbers.

RELIABILITY:

Freescale subjects its products to rigorous testing to ensure reliable performance and compatibility with surface mount assembly processes.

- All surface mount products intended for high temperature board attach using Pb-free solders are fully characterized for MSL and PPT.
- Commercial & industrial products are qualified according to the JEDEC J-STD-020 version in effect at the time of qualification.
- Automotive products are qualified according to AEC-Q100.
- Tin plating is qualified according to the JEDEC JESD201 procedure.

THERMAL ADDENDUM:

Verify each part number for its particular MSL and PPT.

- Search at www.freescale.com by entering all or a portion of the part number (e.g., MC34845 or 34845) in the Part Number Search field.
- Next, click on the 'RoHS' or 'No' value under the 'Compliance Flags RoHS' column. This will open another window with the PPT and MSL.

REFERENCE INFORMATION:

- Find EPP and RoHS information at www.freescale.com/pbfree
- Download a copy of the Freescale solder profile application note by entering 'AN3298' in the KEYWORD SEARCH at www.freescale.com.

Contact your Freescale account representative or send an email to EPPANLST@freescale.com for further EPP assistance.

Small Outline Surface Mount Packages

8 SOICN
Suffix D
Pb-free Suffix EF

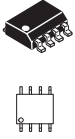

14 SOICN
Suffix D
Pb-free Suffix EF

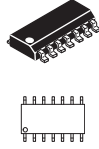

16 SOICN
Suffix D
Pb-free Suffix EF

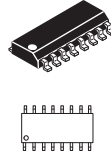

16 SOICW
Suffix DW
Pb-free Suffix EG

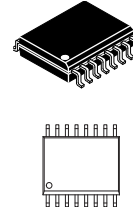

20 SOICW
Suffix DW
Pb-free Suffix EG

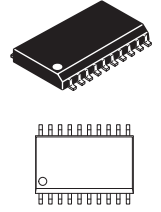

SMALL OUTLINE SURFACE MOUNT PACKAGE DIMENSIONS

| Package | Body Size | | Lead Pitch | | | | | | |
|-------------|-----------|------|------------|------|------|-------|------|------|------|
| | D1 | E1 | e | A | A1 | H | L | b | c |
| SOIC | | | | | | | | | |
| 8 SOICN | 4.90 | 3.90 | 1.27 | 1.55 | 0.18 | 6.00 | 0.83 | 0.43 | 0.22 |
| 14 SOICN | 8.65 | 3.90 | 1.27 | 1.55 | 0.18 | 6.00 | 0.83 | 0.43 | 0.22 |
| 16 SOICN | 9.90 | 3.90 | 1.27 | 1.55 | 0.18 | 6.00 | 0.83 | 0.43 | 0.22 |
| 16 SOICW | 10.30 | 7.50 | 1.27 | 2.50 | 0.18 | 10.30 | 0.70 | 0.43 | 0.28 |
| 20 SOICW | 12.80 | 7.50 | 1.27 | 2.50 | 0.18 | 10.30 | 0.70 | 0.43 | 0.28 |
| 24 SOICW | 15.40 | 7.50 | 1.27 | 2.50 | 0.21 | 10.30 | 0.70 | 0.43 | 0.28 |
| 28 SOICW | 17.93 | 7.50 | 1.27 | 2.50 | 0.21 | 10.30 | 0.70 | 0.43 | 0.28 |
| 32 SOICW | 11.00 | 7.50 | 0.65 | 2.50 | 0.21 | 10.30 | 0.70 | 0.30 | 0.22 |
| 54 SOICW | 17.90 | 7.50 | 0.65 | 2.50 | 0.21 | 10.30 | 0.70 | 0.30 | 0.28 |

All dimensions are in millimeters and are nominal values.

OVERVIEW:

Freescale provides a large selection of proven and reliable small outline surface mount (SOIC) packages in both narrow body (3.90 mm) and wide body (7.50 mm) styles. Lead counts range from 8 to 54 leads and are formed in a popular "gullwing" shape that easily adapts to all surface mount technology (SMT) processes.

KEY FEATURES:

- Narrow SOICN (3.90 mm) and Wide SOICW (7.50 mm) Body Sizes
- Pb-free Terminal Finishes
- Gullwing Lead Forms
- 1.27 mm and 0.65 mm Lead Pitch
- Rail or Tape & Reel Packing Available
- JEDEC Compliant Case Outlines

RELIABILITY:

Freescale subjects their packages to rigorous testing to ensure reliable performance and compatibility with surface mount assembly processes.

- For Moisture Sensitivity levels and Peak Package Temperature, please refer to the "More Info" entry, in the part number ordering table, found at: www.freescale.com. Do a search by part number (e.g. MC34845 or 34845) for the particular Freescale device, to locate the device's part number ordering table. Then select the "Part Data" icon in the Data Sheet/Part Data column.
- All package qualifications performed per the latest version of the AEC-Q100 testing procedures.

Small Outline Surface Mount Packages

| | | | |
|--|--|--|--|
| 24 SOICW Suffix DW Pb-free Suffix EG | 28 SOICW Suffix DW Pb-free Suffix EG | 32 SOICW Fine Pitch Suffix DWB Pb-free Suffix EW | 54 SOICW Fine Pitch Suffix DWB Pb-free Suffix EW |
|--|--|--|--|

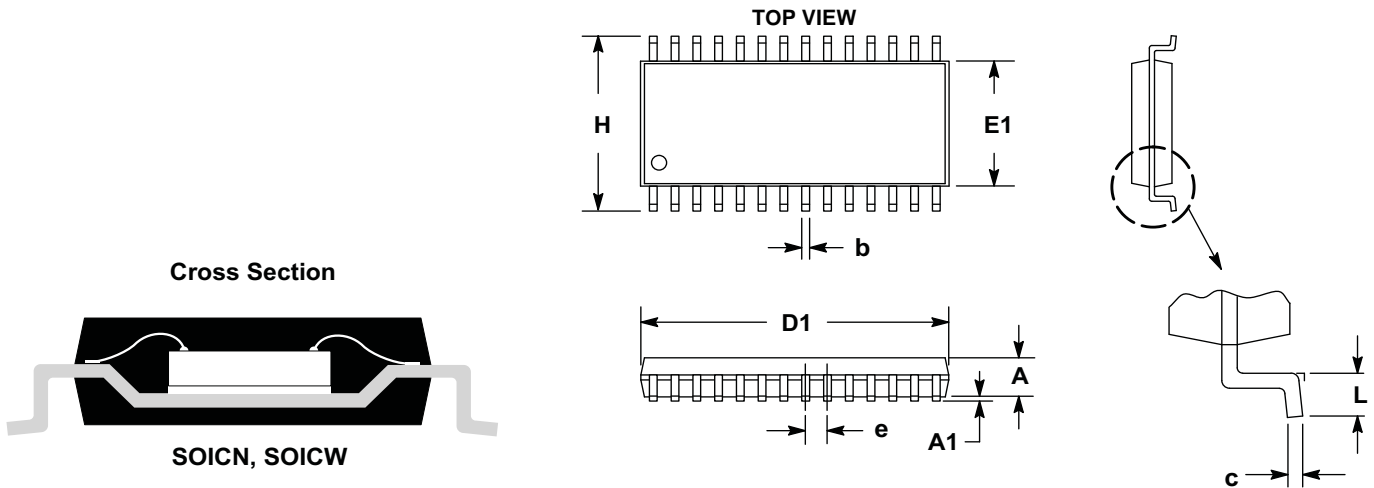
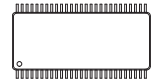
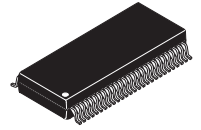
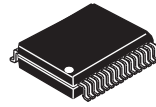
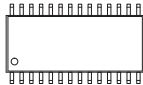
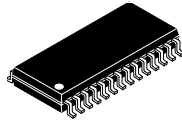
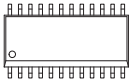
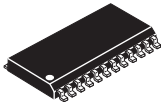

GUIDELINES FOR SOLDERING:

Freescale’s broad array of Small Outline IC’s (SOIC) include the popular “gull wing” lead forms designed to adapt easily to all surface mount (SMT) processes. With the correct pad footprint geometry, the packages will self align to the PCB board when subjected to a solder reflow process.

APPLICATION NOTE

Please refer to application note AN2409 for package information concerning SOICW fine pitch packages. This includes packages without and with exposed thermal pads.

See **THERMAL ADDENDUM:**

| Thermal Resistance | Typical Values | Test Condition |
|--------------------------------|------------------|----------------|
| $R_{\theta JA}$ | 75°C/W - 175°C/W | JESD51-2 |
| $R_{\theta JL}$ | 40°C/W - 80°C/W | JESD51-8 |
| Power Dissipation: Up to 1.5 W | | |

Small Outline Surface Mount Packages

16 TSSOP
Suffix DTB/MTB
Pb-free Suffix EJ

24 TSSOP
Suffix DTB
Pb-free Suffix EJ

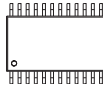
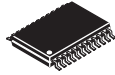
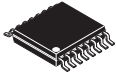

SMALL OUTLINE SURFACE MOUNT PACKAGE (FINE PITCH - TSSOP)

| Package | Body Size | | Lead Pitch e | A | A1 | H | L | b | c |
|---|-----------|------|-----------------|------|------|------|------|------|------|
| | D1 | E1 | | | | | | | |
| TSSOP | | | | | | | | | |
| 16 TSSOP | 5.00 | 4.40 | 0.65 | 1.20 | 0.10 | 6.40 | 0.60 | 0.30 | 0.22 |
| 24 TSSOP | 7.80 | 5.60 | 0.65 | 1.20 | 0.10 | 7.60 | 0.60 | 0.30 | 0.22 |
| All dimensions are in millimeters and are nominal values. | | | | | | | | | |

OVERVIEW:

Freescale provides a large selection of proven and reliable small outline surface mount (SOIC) packages. The TSSOP (4.4 & 5.6 mm) style fall between the SOICN (narrow body) and the SOICW (wide body). The TSSOP range from 16 to 24 pin. The leads are formed in a popular “gullwing” shape that easily adapts to all surface mount technology (SMT) processes.

KEY FEATURES:

- Pb-free Terminal Finishes
- 0.65 mm Lead Pitch
- Tray Packing Available
- Rail or Tape & Reel Packaging Available

RELIABILITY:

Freescale subjects their packages to rigorous testing to ensure reliable performance and compatibility with surface mount assembly processes.

- For Moisture Sensitivity levels and Peak Package Temperature, please refer to the “More Info” entry, in the part number ordering table, found at: www.freescale.com. Do a search by part number (e.g. MC34845 or 34845) for the particular Freescale device, to locate the device’s part number ordering table. Then select the "Part Data" icon in the Data Sheet/Part Data column.
- All package qualifications performed per the latest version of the AEC-Q100 testing procedures.

Small Outline Surface Mount Packages

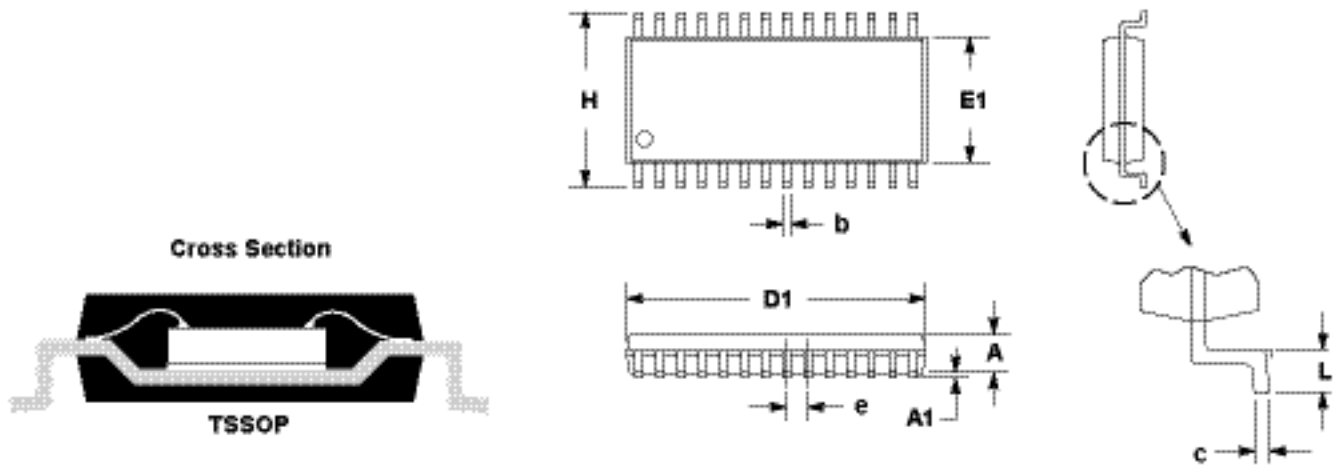

GUIDELINES FOR SOLDERING:

Freescale’s broad array of Small Outline IC’s (SOIC) include the popular “gull wing” lead forms designed to adapt easily to all surface mount (SMT) processes. With the correct pad footprint geometry, the packages will self align to the PCB board when subjected to a solder reflow process.

APPLICATION NOTE

Please refer to application note AN2409 for package information concerning SOICW fine pitch packages. This includes packages without and with exposed thermal pads.

See [THERMAL ADDENDUM:](#)

| Thermal Resistance | Typical Values | Test Condition |
|--------------------------------|-------------------|----------------|
| $R_{\theta JA}$ | 100°C/W - 190°C/W | JESD51-2 |
| Power Dissipation: Up to 1.0 W | | |

Thermally Enhanced Small Outline Surface Mount Packages

24 SOICW
Suffix DW
Pb-free Suffix EG

28 SOICW
Suffix DW
Pb-free Suffix EG

32 SOICW
Suffix DWB
Pb-free Suffix EW

54 SOICW
Suffix DWB
Pb-free Suffix EW

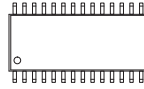
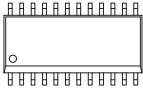
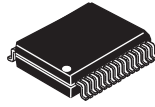
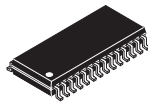
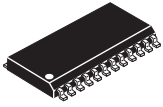

THERMALLY ENHANCED SMALL OUTLINE SURFACE MOUNT PACKAGE DIMENSIONS

| Package | Body Size | | Lead Pitch | | | | | | | | |
|--------------|-----------|------|------------|------|------|------|-------|-------|------|------|------|
| | D1 | E1 | e | A | A1 | F | G | H | L | b | c |
| SOICW | | | | | | | | | | | |
| 24 SOICW | 15.40 | 7.50 | 1.27 | 2.50 | 0.21 | N/A | N/A | 10.30 | 0.67 | 0.43 | 0.25 |
| 28 SOICW | 17.93 | 7.50 | 1.27 | 2.50 | 0.21 | N/A | N/A | 10.30 | 0.66 | 0.43 | 0.25 |
| 32 SOICW | 11.00 | 7.50 | 0.65 | 2.50 | 0.21 | N/A | N/A | 10.30 | 0.70 | 0.30 | 0.25 |
| 54 SOICW | 17.90 | 7.50 | 0.65 | 2.50 | 0.21 | N/A | N/A | 10.30 | 0.70 | 0.30 | 0.25 |
| 32 SOICW-EP | 11.00 | 7.50 | 0.65 | 2.34 | 0.21 | 3.40 | 3.40 | 10.30 | 0.70 | 0.30 | 0.25 |
| 32 SOICW-EP | 11.00 | 7.50 | 0.65 | 2.34 | 0.21 | 4.70 | 4.70 | 10.30 | 0.70 | 0.30 | 0.25 |
| 32 SOICW-EP | 11.00 | 7.50 | 0.65 | 2.34 | 0.21 | 4.60 | 5.70 | 10.30 | 0.70 | 0.30 | 0.25 |
| 54 SOICW-EP | 17.90 | 7.50 | 0.65 | 2.50 | 0.05 | 4.55 | 4.55 | 10.30 | 0.70 | 0.30 | 0.25 |
| 54 SOICW-EP | 17.90 | 7.50 | 0.65 | 2.50 | 0.05 | 4.55 | 6.25 | 10.30 | 0.70 | 0.30 | 0.25 |
| 54 SOICW-EP | 17.90 | 7.50 | 0.65 | 2.50 | 0.05 | 5.05 | 10.30 | 10.30 | 0.70 | 0.30 | 0.25 |

All dimensions are in millimeters and are nominal values.

Note: -EP denotes Exposed Thermal Pad

OVERVIEW:

Thermally enhanced SOIC packages are also available to increase the power dissipation capability up to 2X for a given IC application, thereby expanding the margin of operating parameters possible.

Enhancements are made such as thermal leads tied to die pads or exposed die pads that can be directly soldered to a multi-layer PCB board heat sink or thermal vias.

KEY FEATURES:

- 7.50 mm wide SOIC Body Sizes
- Thermal Leads and/or Exposed Pad for Increased Performance
- Pb-free Terminal Finishes
- Gullwing Lead Forms
- 1.27 mm and 0.65 mm Lead Pitch
- Rail or Tape & Reel Packing Available

RELIABILITY:

Freescale subjects their packages to rigorous testing to ensure reliable performance and compatibility with surface mount assembly processes.

- For Moisture Sensitivity levels and Peak Package Temperature, please refer to the "More Info" entry, in the part number ordering table, found at: www.freescale.com. Do a search by part number (e.g. MC34845 or 34845) for the particular Freescale device, to locate the device's part number ordering table. Then select the "Part Data" icon in the Data Sheet/Part Data column.
- All package qualifications performed per the latest version of the AEC-Q100 testing procedures.

Thermally Enhanced Small Outline Surface Mount Packages

32 SOICW-EP
Exposed Pad
Suffix DWB
Pb-free Suffix EK

54 SOICW-EP
Exposed Pad
Suffix DWB
Pb-free Suffix EK

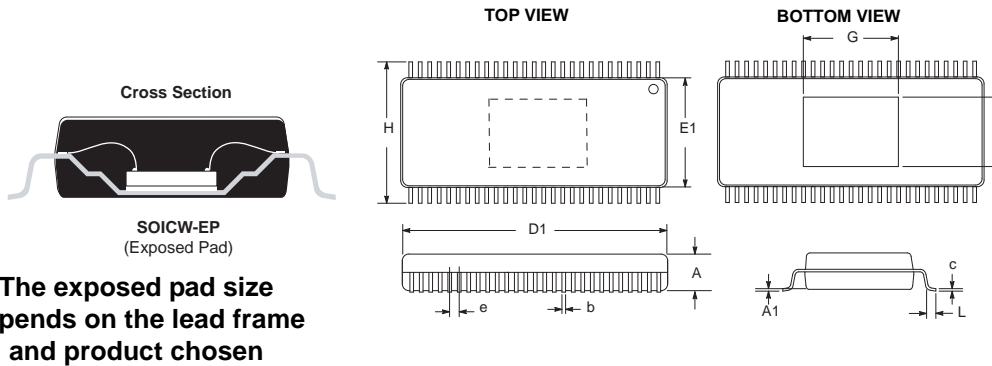
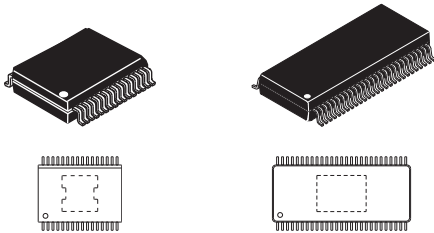

GUIDELINES FOR SOLDERING:

Freescale's broad array of Small Outline IC's (SOIC) include the popular "gull wing" lead forms designed to adapt easily to all surface mount (SMT) processes. With the correct pad footprint geometry, the packages will self align to the PCB board when subjected to a solder reflow process. Thermal leads or an exposed pad should be soldered directly to a multi-layered PCB with thermal via holes to realize the greatest potential of the enhanced SOICW packages. Refer to AN2409, and device specific thermal data.

APPLICATION NOTE

Please refer to application note AN2409 for package information concerning SOICW fine pitch packages. This includes packages without and with exposed thermal pads.

See THERMAL ADDENDUM:

| Thermal Resistance | Typical Values | Test Condition |
|--|------------------|----------------|
| $R_{\theta JA}$ | 60°C/W - 100°C/W | JESD51-2 |
| $R_{\theta JL}$ | 10°C/W - 40°C/W | JESD51-8 |
| $R_{\theta JC}^*$ | 1°C/W - 2°C/W | JESD51-8 |
| *SOICW-Exposed Pad Power Dissipation: Up to 4.0 W | | |

Heatsink Small Outline Surface Mount Packages

20 HSOP
Suffix DH
Pb-free Suffix VW

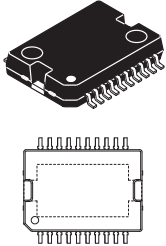

30 HSOP
Suffix DH
Pb-free Suffix VW

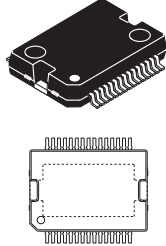

36 HSOP
Suffix DH
Pb-free Suffix VW

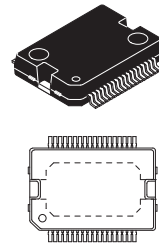

44 HSOP
Suffix DH
Pb-free Suffix VW

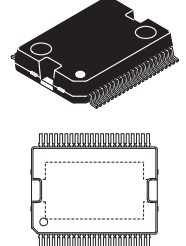

HEATSINK SMALL OUTLINE SURFACE MOUNT PACKAGE DIMENSIONS

| Package | Body Size | | Lead Pitch | | | | | | | | |
|-------------|-----------|-------|------------|------|------|-------|-------|------|------|------|------|
| | D | E1 | e | A | A3 | D1 | E | E3 | L | b | c |
| HSOP | | | | | | | | | | | |
| 20 HSOP | 15.90 | 11.00 | 1.27 | 3.00 | 0.20 | 12.20 | 14.20 | 6.80 | 0.97 | 0.46 | 0.30 |
| 30 HSOP | 15.90 | 11.00 | 0.80 | 3.00 | 0.20 | 12.20 | 14.20 | 6.90 | 0.97 | 0.41 | 0.30 |
| 36 HSOP | 15.90 | 11.00 | 0.65 | 3.15 | 0.10 | 11.00 | 14.20 | 6.80 | 0.95 | 0.32 | 0.30 |
| 44 HSOP | 15.90 | 11.00 | 0.65 | 3.20 | 0.08 | 12.20 | 14.20 | 6.90 | 0.97 | 0.29 | 0.30 |

All dimensions are in millimeters and are nominal values.

OVERVIEW:

Freescale offers a family of Heatsink Small Outline Packages (HSOP) that have significantly improved thermal performance characteristics as compared to traditional small outline packages (SOIC). The HSOP's have an internally integrated copper heat slug that provides a direct path for heat conduction away from an IC and into a solder attached PCB board (heatsink or thermal vias).

KEY FEATURES:

- Mechanically Attached Thick Copper Heat Slug
- Pb-free Terminal Finish
- Lead Pitch Ranging from 0.65 mm to 1.27 mm
- Gullwing Lead Forms
- Rail or Tape & Reel Packing Available

RELIABILITY:

Freescale subjects their packages to rigorous testing to ensure reliable performance and compatibility with surface mount assembly processes.

- For Moisture Sensitivity levels and Peak Package Temperature, please refer to the "More Info" entry, in the part number ordering table, found at: www.freescale.com. Do a search by part number (e.g. MC34845 or 34845) for the particular Freescale device, to locate the device's part number ordering table. Then select the "Part Data" icon in the Data Sheet/Part Data column.
- All package qualifications performed per the latest version of the AEC-Q100 testing procedures.

Heatsink Small Outline Surface Mount Package

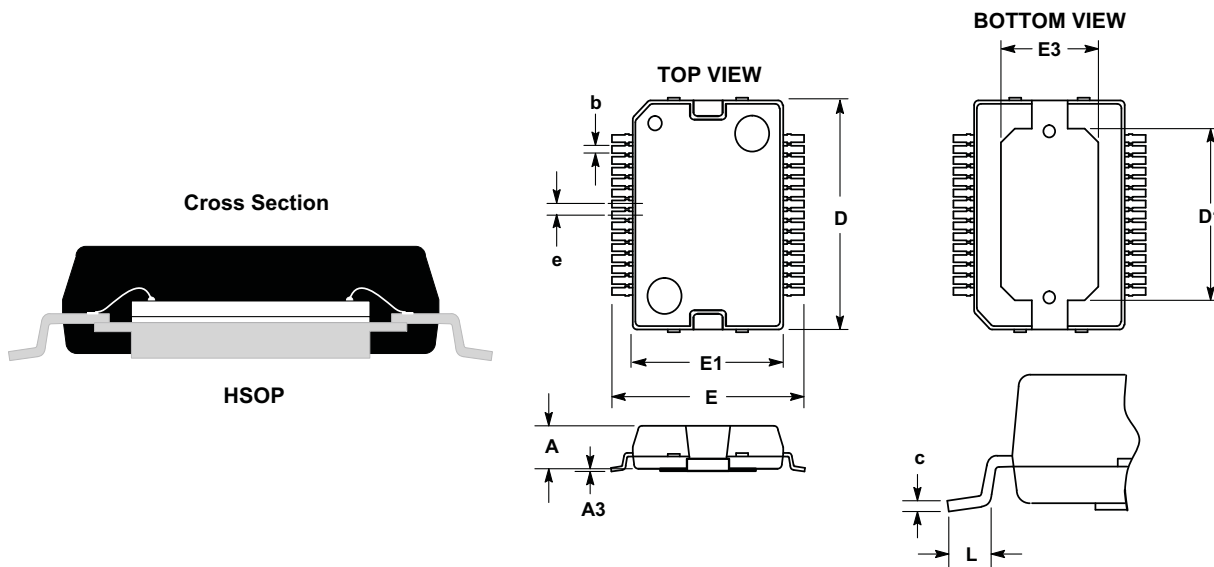

GUIDELINES FOR SOLDERING:

The Freescale portfolio of Heatsink Small Outline Packages include the popular "gull wing" lead forms designed to adapt easily to all surface mount (SMT) processes. With the correct pad footprint geometry, the packages will self align to the PCB board when subjected to a solder reflow process. The copper slug should be soldered directly to a multi-layered PCB with thermal via holes to realize the greatest potential of the HSOP power packages.

APPLICATION NOTE

Please refer to application note AN2388 for package information concerning HSOP packages.

See THERMAL ADDENDUM:

| Thermal Resistance | Typical Values | Test Condition |
|---------------------------------|-----------------|----------------|
| $R_{\theta JA}$ | 30°C/W - 40°C/W | JESD51-2 |
| $R_{\theta JL}$ | 12°C/W - 15°C/W | JESD51-8 |
| $R_{\theta JC}$ | 0.5°C/W - 1°C/W | JESD51-5 |
| Power Dissipation: 2.0 to 4.0 W | | |

Quad Flat Pack Surface Mount Packages (LQFP)

32 LQFP
Suffix FTB
Pb-free Suffix AC

44 LQFP
Suffix FTB
Pb-free Suffix AC

48 LQFP
Suffix FTA
Pb-free Suffix AE

52 LQFP
Suffix FTB
Pb-free Suffix AE

64 LQFP
Suffix FTA
Pb-free Suffix AE

80 LQFP
Suffix FTB
Pb-free Suffix AF

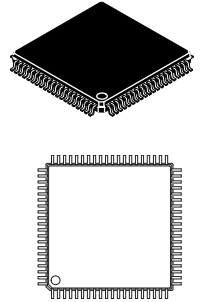
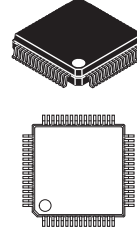
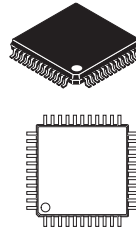
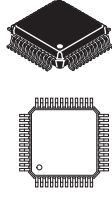
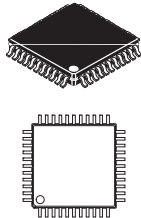
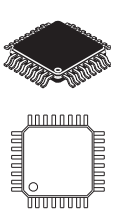

QUAD FLAT PACK SURFACE MOUNT PACKAGE DIMENSIONS

| Package | Body Size | | Lead Pitch | | | | | | | |
|-------------|-----------|-------|------------|------|------|-------|-------|------|------|------|
| | D1 | E1 | e | A1 | A2 | D | E | L | b | c |
| LQFP | | | | | | | | | | |
| 32 LQFP | 7.00 | 7.00 | 0.80 | 0.10 | 1.40 | 9.00 | 9.00 | 0.60 | 0.38 | 0.15 |
| 44 LQFP | 10.00 | 10.00 | 0.80 | 0.10 | 1.40 | 12.00 | 12.00 | 0.60 | 0.38 | 0.15 |
| 48 LQFP | 7.00 | 7.00 | 0.50 | 0.10 | 1.40 | 9.00 | 9.00 | 0.60 | 0.22 | 0.15 |
| 52 LQFP | 10.00 | 10.00 | 0.65 | 0.10 | 1.40 | 12.00 | 12.00 | 0.60 | 0.30 | 0.15 |
| 64 LQFP | 10.00 | 10.00 | 0.50 | 0.10 | 1.40 | 12.00 | 12.00 | 0.60 | 0.22 | 0.15 |
| 80 LQFP | 14.00 | 14.00 | 0.65 | 0.10 | 1.40 | 16.00 | 16.00 | 0.60 | 0.30 | 0.15 |
| 100 LQFP | 14.00 | 14.00 | 0.50 | 0.10 | 1.40 | 16.00 | 16.00 | 0.60 | 0.22 | 0.15 |
| 144 LQFP | 20.00 | 20.00 | 0.50 | 0.10 | 1.40 | 22.00 | 22.00 | 0.60 | 0.22 | 0.15 |

All dimensions are in millimeters and are nominal values.

OVERVIEW:

Low-profile quad flat packages (LQFPs) are classified by the overall thickness per JEDEC definition. For Analog Products, Freescale offers both package styles in lead counts ranging from 32 to 144 to cover a large range of applications.

KEY FEATURES:

- Body Sizes Ranging from 7 mm x 7 mm to 20 mm x 20 mm
- Pb-free Terminal Finishes
- Gullwing Lead Forms
- Lead Pitch Ranging from 0.50 mm to 0.80 mm
- Tray Packing Available
- JEDEC Compliant Case Outlines
- Low Profile "L" (1.4 mm) Body Thickness Options
- Exposed Pad "EP" available for Increased Thermal Performance

RELIABILITY:

Freescale subjects their packages to rigorous testing to ensure reliable performance and compatibility with surface mount assembly processes.

- For Moisture Sensitivity levels and Peak Package Temperature, please refer to the "More Info" entry, in the part number ordering table, found at: www.freescale.com. Do a search by part number (e.g. MC34845 or 34845) for the particular Freescale device, to locate the device's part number ordering table. Then select the "Part Data" icon in the Data Sheet/Part Data column.
- All package qualifications performed per the latest version of the AEC-Q100 testing procedures.

Quad Flat Pack Surface Mount Packages (LQFP)

100 LQFP
Suffix FTA
Pb-free Suffix AF

144 LQFP
Suffix FTA
Pb-free Suffix AG

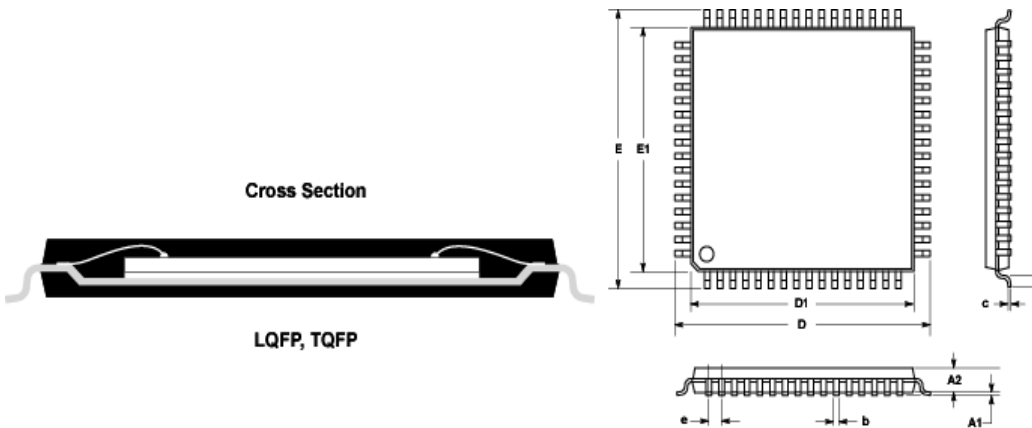
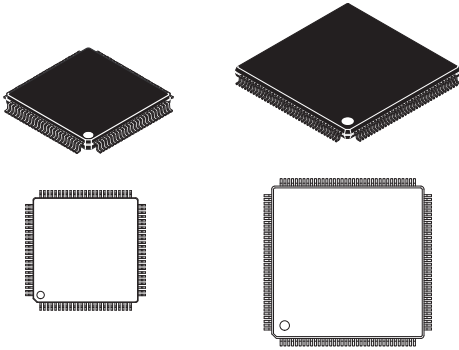

GUIDELINES FOR SOLDERING:

Freescale's broad selection of Quad Flat Pack packages include the popular "gull wing" lead forms designed to adapt easily to all surface mount (SMT) processes. With the correct pad footprint geometry, the packages will self align to the PCB board when subjected to a solder reflow process.

APPLICATION NOTE

Please refer to application note AN4388 for package information concerning QFP packages.

See THERMAL ADDENDUM:

| Thermal Resistance | Typical Values | Test Condition |
|---------------------------------|-----------------|----------------|
| $R_{\theta JA}$ | 30°C/W - 80°C/W | JESD51-2 |
| $R_{\theta JL}$ | 12°C/W - 55°C/W | JESD51-8 |
| $R_{\theta JC}$ | 1°C/W - 2°C/W | JESD51-5 |
| Power Dissipation: 2.0 to 5.0 W | | |

Thermally Enhanced Quad Flat Pack Surface Mount Packages

48 LQFP-EP
Exposed Pad
Suffix FTA
Pb-free Suffix AM

64 LQFP-EP
Exposed Pad
Suffix FTA
Pb-free Suffix AM

128 LQFP-EP
Exposed Pad
Suffix FTA
Pb-free Suffix AK

80 TQFP-EP
Exposed Pad
Suffix FTA
Pb-free Suffix AM

100 TQFP-EP
Exposed Pad
Suffix FTA
Pb-free Suffix AK

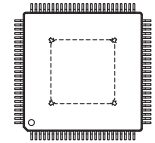
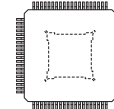
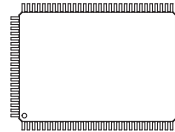
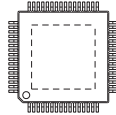
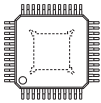
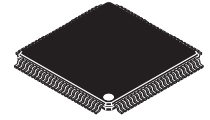
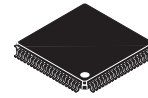
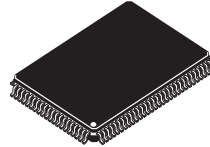
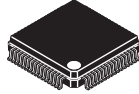
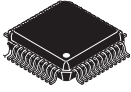

THERMALLY ENHANCED QUAD FLAT PACK SURFACE MOUNT PACKAGE DIMENSIONS

| Package | Body Size | | Lead Pitch e | A1 | A2 | D | E | F | G | L | b | c |
|---|-----------|-------|-----------------|------|------|-------|-------|------|------|------|------|------|
| | D1 | E1 | | | | | | | | | | |
| LQFP | | | | | | | | | | | | |
| 48 LQFP-EP | 7.0 | 7.0 | 0.50 | 0.10 | 1.40 | 9.00 | 9.00 | 4.50 | 4.50 | 0.60 | 0.20 | 0.14 |
| 64 LQFP-EP | 10.00 | 10.00 | 0.50 | 0.10 | 1.40 | 12.00 | 12.00 | 6.50 | 6.50 | 0.60 | 0.22 | 0.15 |
| 128 LQFP-EP | 14.00 | 20.00 | 0.50 | 0.10 | 1.40 | 22.00 | 16.00 | 9.20 | 9.20 | 0.60 | 0.22 | 0.15 |
| TQFP | | | | | | | | | | | | |
| 80 TQFP-EP | 12.00 | 12.00 | 0.50 | 0.10 | 1.00 | 14.00 | 14.00 | 5.60 | 5.60 | 0.60 | 0.22 | 0.15 |
| 100 TQFP-EP | 14.00 | 14.00 | 0.50 | 0.10 | 1.00 | 16.00 | 16.00 | 9.00 | 9.00 | 0.60 | 0.22 | 0.15 |
| 128 TQFP-EP | 14.00 | 14.00 | 0.40 | 0.10 | 1.00 | 16.00 | 16.00 | 8.85 | 8.85 | 0.60 | 0.18 | 0.15 |
| All dimensions are in millimeters and are nominal values. | | | | | | | | | | | | |

Note: -EP denotes Exposed Thermal Pad

OVERVIEW:

Thin quad flat packages (TQFPs) and low-profile quad flat packages (LQFPs) are classified by the overall thickness per JEDEC definition. For Analog Products, Freescale offers both package styles in lead counts ranging from 48 to 128 to cover a large range of applications. Exposed pad (LQFP-EP and TQFP-EP) packages are available for increased thermal performance requirements. The exposed pad or copper heat slug should be soldered directly to a multi-layered PCB board to realize the greatest performance.

KEY FEATURES:

- Body Sizes Ranging from 7 mm x 7 mm to 14 mm x 14 mm
- Pb-free Terminal Finishes
- Gullwing Lead Forms
- Lead Pitch Ranging from 0.40 mm to 0.65 mm
- Tray Packing Available
- JEDEC Compliant Case Outlines

- Low Profile "L" (1.4 mm) and Thin "T" (1.0 mm) Body Thickness Options
- Exposed Pad "EP" available for Increased Thermal Performance

RELIABILITY:

Freescale subjects their packages to rigorous testing to ensure reliable performance and compatibility with surface mount assembly processes.

- For Moisture Sensitivity levels and Peak Package Temperature, please refer to the "More Info" entry, in the part number ordering table, found at: www.freescale.com. Do a search by part number (e.g. MC34845 or 34845) for the particular Freescale device, to locate the device's part number ordering table. Then select the "Part Data" icon in the Data Sheet/Part Data column.
- All package qualifications performed per the latest version of the AEC-Q100 testing procedures.

Thermally Enhanced Quad Flat Pack Surface Mount Packages

128 TQFP-EP
Exposed Pad
Suffix FTA
Pb-free Suffix AK

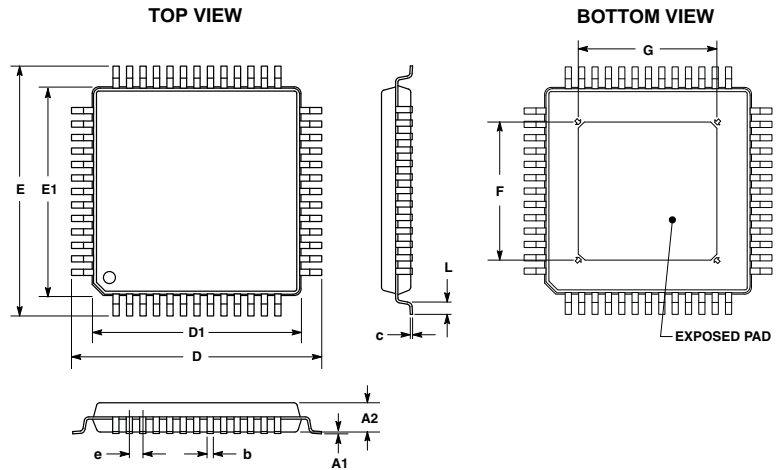
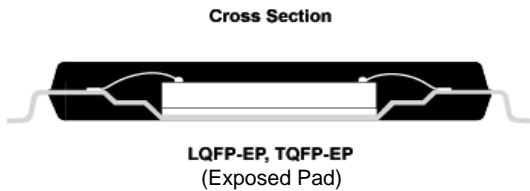
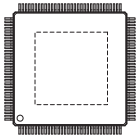

GUIDELINES FOR SOLDERING:

Freescale's broad selection of Quad Flat Pack packages include the popular "gull wing" lead forms designed to adapt easily to all surface mount (SMT) processes. With the correct pad footprint geometry, the packages will self align to the PCB board when subjected to a solder reflow process.

APPLICATION NOTE

Please refer to application note AN4388 for package information concerning QFP packages.

See THERMAL ADDENDUM:

| Thermal Resistance | Typical Values | Test Condition |
|---------------------------------|-----------------|----------------|
| $R_{\theta JA}$ | 30°C/W - 80°C/W | JESD51-2 |
| $R_{\theta JL}$ | 12°C/W - 55°C/W | JESD51-8 |
| $R_{\theta JC}$ | 1°C/W - 2°C/W | JESD51-5 |
| Power Dissipation: 2.0 to 5.0 W | | |

Dual Flat No-Lead Surface Mount Packages

6 UDFN-EP
Suffix FC
Pb-free Suffix EP

8 UDFN
Suffix FC
Pb-free Suffix EP

10 UDFN-EP
Suffix FC
Pb-free Suffix EP

6 DFN-EP
Suffix FC
Pb-free Suffix EP

10 DFN-EP
Suffix FC
Pb-free Suffix EP

Bottom View



Bottom View



Bottom View



Bottom View



Bottom View



DUAL FLAT NO-LEAD SURFACE MOUNT PACKAGE DIMENSIONS - UDFN

| Package | Body Size | | Lead Pitch | | | | | | |
|---|-----------|------|------------|------|------|------|------|------|------|
| | D1 | E1 | e | A1 | A2 | F | G | L | b |
| UDFN | | | | | | | | | |
| 6 UDFN-EP | 2.00 | 2.00 | 0.65 | 0.02 | 0.60 | 0.95 | 1.40 | 0.25 | 0.25 |
| 8 UDFN -EP | 2.00 | 3.00 | 0.50 | 0.02 | 0.55 | 0.95 | 1.35 | 0.55 | 0.25 |
| 10 UDFN-EP | 3.00 | 3.00 | 0.50 | 0.02 | 0.55 | 1.60 | 2.20 | 0.40 | 0.24 |
| DFN | | | | | | | | | |
| 6 DFN-EP | 3.00 | 3.00 | 0.95 | 0.02 | 0.80 | 1.60 | 2.40 | 0.40 | 0.37 |
| 10 DFN-EP | 3.00 | 2.00 | 0.50 | 0.03 | 0.90 | 0.50 | 0.41 | 0.40 | 0.24 |
| All dimensions are in millimeters and are nominal values. | | | | | | | | | |

Note: -EP denotes Exposed Thermal Pad

OVERVIEW:

A unique MAP (mold array package) packaging process developed by Freescale is used to create a lead-less surface mount package. Freescale's dual and quad flat no-lead (DFN, QFN) packages provide a cost-effective answer to the demand for reliable and high performance packaging, including some versions with enhanced thermal management characteristics.

KEY FEATURES:

- Pb-free Terminal Finishes
- 0.40, 0.50, 0.65, 0.80, and 0.95 mm Lead Pitch
- Tray Packing Available
- JEDEC Compliant Case Outlines
- Exposed Pad (some)
- DFN (dual flat no-lead) package 0.50 to 1.00 mm body thickness
- UDFN (ultra-thin DFN) package 0.50 to 0.65 mm body thickness

- UF-QFN (ultra-thin, fine pitch QFN) package 0.50 to 0.65 mm body thickness

RELIABILITY:

Freescale subjects their packages to rigorous testing to ensure reliable performance and compatibility with surface mount assembly processes.

- For Moisture Sensitivity levels and Peak Package Temperature, please refer to the "More Info" entry, in the part number ordering table, found at: www.freescale.com. Do a search by part number (e.g. MC34845 or 34845) for the particular Freescale device, to locate the device's part number ordering table. Then select the "Part Data" icon in the Data Sheet/Part Data column.
- All package qualifications performed per the latest version of the AEC-Q100 testing procedures.

See **PB-FREE Termination Suffix:**

Quad Flat No-Lead Surface Mount Packages

| | | | | | |
|---|---|--|--|--|--|
| 16 QFN-EP Suffix FC Pb-free Suffix EP | 16 QFN-EP Suffix FC Pb-free Suffix EP | 20 UF-QFN-EP Suffix FC Pb-free Suffix EP | 20 UF-QFN-EP Suffix FC Pb-free Suffix EP | 20 UF-QFN-EP Suffix FC Pb-free Suffix EP | 20 UF-QFN-EP Suffix FC Pb-free Suffix EP |
|---|---|--|--|--|--|

Bottom View



Bottom View



Bottom View



Bottom View



Bottom View



Bottom View

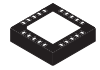

QUAD FLAT NO-LEAD SURFACE MOUNT PACKAGE DIMENSIONS - QFN

| Package | Body Size | | Lead Pitch | | | | | | |
|--------------|-----------|------|------------|------|------|------|------|------|------|
| | D1 | E1 | e | A1 | A2 | F | G | L | b |
| QFN | | | | | | | | | |
| 16 QFN-EP | 3.00 | 3.00 | 0.50 | 0.03 | 0.90 | 1.60 | 1.60 | 0.40 | 0.24 |
| 16 QFN-EP | 5.00 | 5.00 | 0.80 | 0.03 | 0.90 | 3.60 | 3.60 | 0.55 | 0.30 |
| 20 UF-QFN-EP | 3.00 | 3.00 | 0.40 | 0.03 | 0.56 | 1.68 | 1.68 | 0.40 | 0.20 |
| 20 UF-QFN-EP | 3.00 | 4.00 | 0.50 | 0.03 | 0.58 | 2.63 | 1.63 | 0.40 | 0.24 |
| 20 UF-QFN-EP | 4.00 | 3.00 | 0.50 | 0.03 | 0.55 | 1.65 | 2.65 | 0.40 | 0.24 |
| 20 UF-QFN-EP | 4.00 | 4.00 | 0.50 | 0.03 | 0.58 | 2.80 | 2.80 | 0.40 | 0.24 |
| 24 QFN-EP | 4.00 | 4.00 | 0.50 | 0.03 | 0.90 | 2.60 | 2.60 | 0.40 | 0.24 |
| 24 UF-QFN-EP | 4.00 | 4.00 | 0.50 | 0.03 | 0.58 | 2.80 | 2.80 | 0.40 | 0.24 |
| 26 QFN-EP | 5.00 | 5.00 | 0.50 | 0.03 | 0.90 | 3.65 | 3.65 | 0.40 | 0.24 |
| 32 QFN -EP | 5.00 | 5.00 | 0.50 | 0.03 | 0.90 | 3.10 | 3.10 | 0.40 | 0.24 |
| 32 QFN -EP | 5.00 | 5.00 | 0.50 | 0.03 | 0.90 | 3.65 | 3.65 | 0.40 | 0.24 |
| 32 QFN-EP | 7.00 | 7.00 | 0.65 | 0.03 | 0.90 | 4.70 | 4.70 | 0.63 | 0.30 |
| 32 QFN-EP | 5.00 | 5.00 | 0.50 | 0.03 | 0.90 | 3.50 | 3.50 | 0.50 | 0.24 |
| 44 QFN-EP | 9.00 | 9.00 | 0.65 | 0.03 | 0.90 | 6.70 | 6.70 | 0.63 | 0.30 |
| 48 QFN-EP | 7.00 | 7.00 | 0.50 | 0.03 | 1.00 | 5.10 | 5.10 | 0.40 | 0.24 |
| 56 QFN-EP | 7.00 | 7.00 | 0.40 | 0.03 | 0.90 | 5.10 | 5.10 | 0.40 | 0.20 |
| 56 QFN | 8.00 | 8.00 | 0.50 | 0.03 | 0.90 | n/a | n/a | 0.40 | 0.24 |
| 64 QFN | 9.00 | 9.00 | 0.50 | 0.30 | 0.75 | n/a | n/a | 0.63 | 0.24 |

All dimensions are in millimeters and are nominal values.

Note: -EP denotes Exposed Thermal Pad

Quad Flat No-Lead Surface Mount Packages (cont.)

| | | | | | |
|---|--|---|---|---|---|
| 24 QFN-EP Suffix FC Pb-free Suffix EP | 24 UF-QFN-EP Suffix FC Pb-free Suffix EP | 26 QFN-EP Suffix FC Pb-free Suffix EP | 32 QFN-EP Suffix FC Pb-free Suffix EP | 32 QFN-EP Suffix FC Pb-free Suffix EP | 32 QFN-EP Suffix FC Pb-free Suffix EP |
|---|--|---|---|---|---|

Bottom View

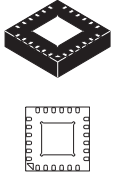

Bottom View

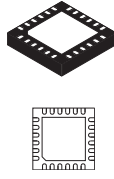

Bottom View

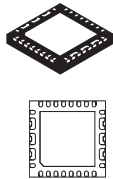

Bottom View

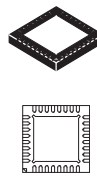

Bottom View

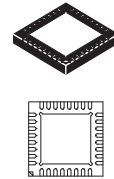

Bottom View

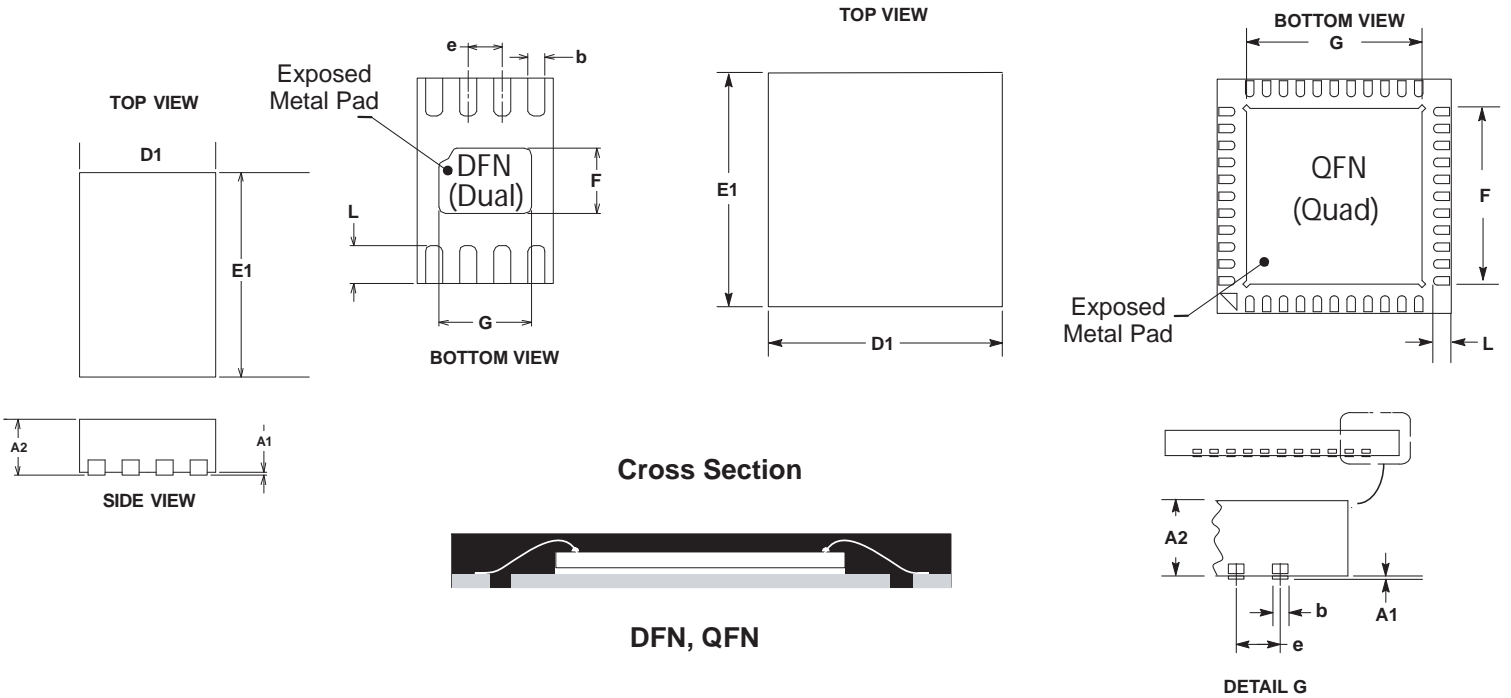
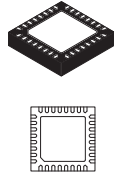

See **THERMAL ADDENDUM:**

| Thermal Resistance | Typical Values | Test Condition |
|---------------------------------|-----------------|----------------|
| $R_{\theta JA}$ | 35°C/W - 80°C/W | JESD51-2 |
| $R_{\theta JL}$ | 12°C/W - 55°C/W | JESD51-8 |
| $R_{\theta JC}$ | 1°C/W - 2°C/W | JESD51-5 |
| Power Dissipation: 1.5 to 5.0 W | | |

Quad Flat No-Lead Surface Mount Packages (cont.)

44 QFN-EP
Suffix FC
Pb-free Suffix EPP

48 QFN-EP
Suffix FC
Pb-free Suffix EP

56 QFN-EP
Suffix FC
Pb-free Suffix EP

56 QFN
Suffix FC
Pb-free Suffix EP

64 QFN
Suffix FC
Pb-free Suffix EP

Bottom View

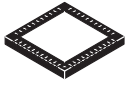

Bottom View

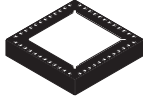

Bottom View

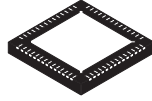

Bottom View

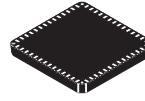

Bottom View

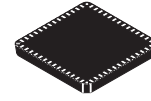

GUIDELINES FOR SOLDERING:

Freescale's selection of Dual and Quad Flat No-Lead Packages provide space efficient solutions for surface mount (SMT) processes. With the correct pad footprint geometry, the packages will self align to the PCB board when subjected to a solder reflow process. The exposed pad or copper heat slug should be soldered directly to a multi-layered PCB board to realize the greatest performance.

APPLICATION NOTE

Please refer to application note AN1902 for package information concerning QFN packages.

Power Quad Flat No-Lead Surface Mount Packages

| | | |
|---|---|---|
| 16 PQFN 5 mm x 5 mm Pb-free Suffix PNB | 32 PQFN 8 mm x 8 mm Pb-free Suffix PNB | 36 PQFN 9 mm x 9 mm Pb-free Suffix PNB |
|---|---|---|

Bottom View



Bottom View

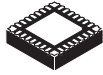

Bottom View

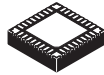

POWER QUAD FLAT NO-LEAD SURFACE MOUNT PACKAGE - (PQFN)

| Package | Body Size | | Lead Pitch | | | | | |
|---|-----------|---|------------|------|-----|-----|------|------|
| | A | B | e | A1 | F | G | L | b |
| PQFN | | | | | | | | |
| 16 PQFN | 5 | 5 | 0.80 | 2.10 | 2.0 | 2.0 | 1.05 | 0.55 |
| 32 PQFN | 8 | 8 | 0.80 | 2.10 | 5.0 | 5.0 | 1.05 | 0.54 |
| 36 PQFN | 9 | 9 | 0.80 | 2.10 | 6.0 | 6.0 | 1.05 | 0.54 |
| All dimensions are in millimeters and are nominal values. | | | | | | | | |

OVERVIEW:

A unique MAP packaging process developed by Freescale is used to create a lead-less surface mount package with enhanced thermal capability. Freescale's Power Quad Flat No-Lead (PQFN) packages provide a cost-effective answer to the demand for reliable and high performance packaging with enhanced thermal management characteristics in a small form factor.

KEY FEATURES:

- Pb-free Terminal Finishes
- 0.8 mm Lead Pitch
- Tray Packing Available
- Exposed Pad(s)
- Quick time to market for new devices

RELIABILITY:

Freescale subjects their packages to rigorous testing to ensure reliable performance and compatibility with surface mount assembly processes.

- For Moisture Sensitivity levels and Peak Package Temperature, please refer to the "More Info" entry, in the part number ordering table, found at: www.freescale.com. Do a search by part number (e.g. MC34845 or 34845) for the particular Freescale device, to locate the device's part number ordering table. Then select the "Part Data" icon in the Data Sheet/Part Data column.
- All package qualifications performed per the latest version of the AEC-Q100 testing procedures.

Power Quad Flat No-Lead Surface Mount Packages

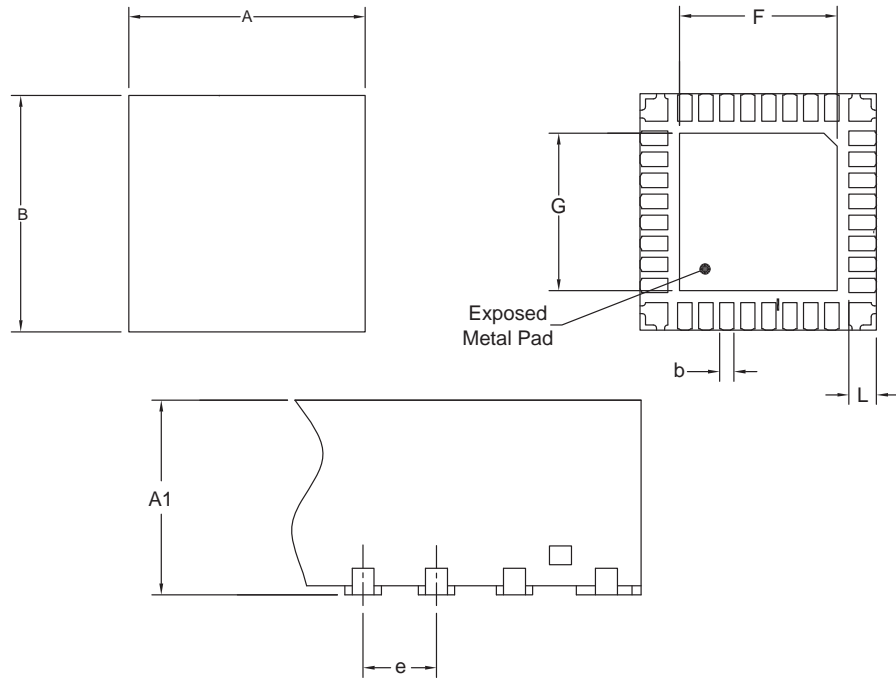

GUIDELINES FOR SOLDERING:

Freescale’s selection of Quad Flat No-Lead Packages provide space efficient solutions for surface mount (SMT) processes. With the correct pad footprint geometry, the packages will self align to the PCB board when subjected to a solder reflow process. The exposed pad or copper heat slug should be soldered directly to a multi-layered PCB board to realize the greatest performance.

APPLICATION NOTE

Please refer to application note AN2467 for package information concerning PQFN packages.

See THERMAL ADDENDUM:

| Thermal Resistance | Typical Values | Test Condition |
|--------------------|-----------------------------|----------------|
| $R_{\theta JA}$ | Refer to Product Data Sheet | |
| $R_{\theta JA}$ | Refer to Product Data Sheet | |
| $R_{\theta JA}$ | Refer to Product Data Sheet | |

Power Quad Flat No-Lead Surface Mount Packages

23 PQFN
12 mm x 12 mm
Pb-free Suffix PNA

16 PQFN
12 mm x 12 mm
Pb-free Suffix PNA

24 PQFN
12 mm x 12 mm
Pb-free Suffix PNA

36 PQFN
12 mm x 12 mm
Pb-free Suffix PNB

Bottom View

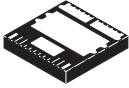

Bottom View

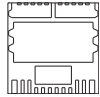
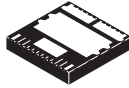

Bottom View

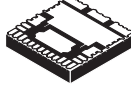

Bottom View

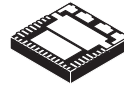

POWER QUAD FLAT NO-LEAD SURFACE MOUNT PACKAGE - (PQFN)

| Package | Body Size | | Lead Pitch | A1 |
|-------------|-----------|----|------------|------|
| | A | B | e | |
| PQFN | | | | |
| 23 PQFN | 12 | 12 | 0.90 | 2.10 |
| 16/24 PQFN | 12 | 12 | 0.90 | 2.10 |
| 36 PQFN | 12 | 12 | 0.80 | 2.10 |

All dimensions are in millimeters and are nominal values.

Notes: Heatsink pads location and size may vary. Refer to the Device Data Sheet for actual physical dimensions.
Freescale is investigating other pin pitches, including 0.65 mm (suffix PNC).

OVERVIEW:

A unique MAP packaging process developed by Freescale is used to create a lead-less surface mount package with enhanced thermal capability. Freescale's Power Quad Flat No-Lead (PQFN) packages provide a cost-effective answer to the demand for reliable and high performance packaging with enhanced thermal management characteristics in a small form factor.

KEY FEATURES:

- Pb-free Terminal Finishes
- 0.8, and 0.9 mm Lead Pitch
- Tray Packing Available
- Exposed Pad(s)
- Quick time to market for new devices

RELIABILITY:

Freescale subjects their packages to rigorous testing to ensure reliable performance and compatibility with surface mount assembly processes.

- For Moisture Sensitivity levels and Peak Package Temperature, please refer to the "More Info" entry, in the part number ordering table, found at: www.freescale.com. Do a search by part number (e.g. MC34845 or 34845) for the particular Freescale device, to locate the device's part number ordering table. Then select the "Part Data" icon in the Data Sheet/Part Data column.
- All package qualifications performed per the latest version of the AEC-Q100 testing procedures.

Power Quad Flat No-Lead Surface Mount Packages

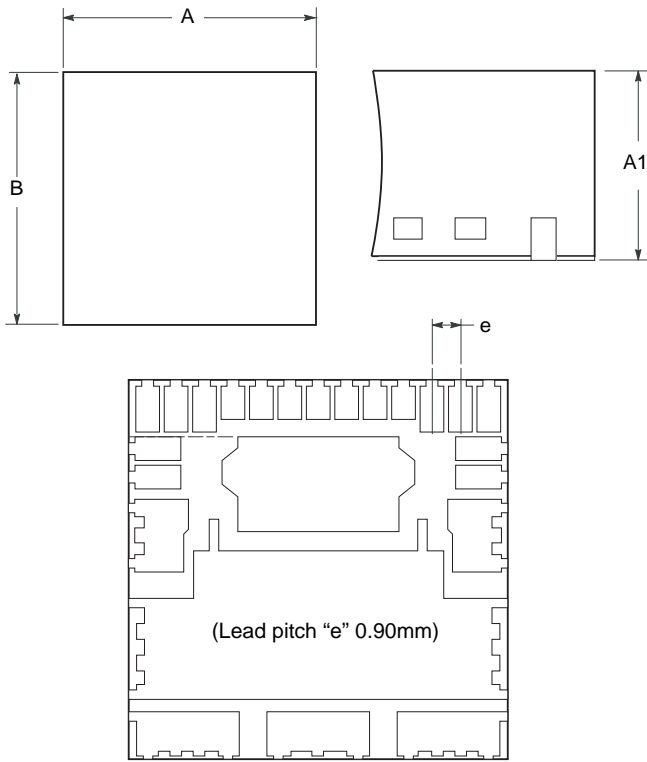

Heatsink/Pin Layouts Vary by Device for Each Package or Product

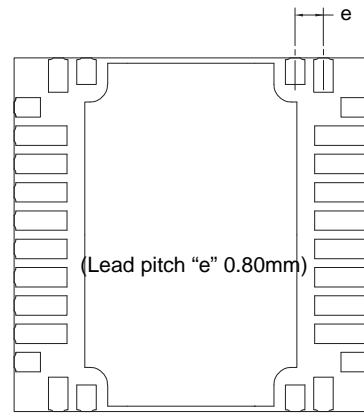

GUIDELINES FOR SOLDERING:

Freescale’s selection of Quad Flat No-Lead Packages provide space efficient solutions for surface mount (SMT) processes. With the correct pad footprint geometry, the packages will self align to the PCB board when subjected to a solder reflow process. The exposed pad or copper heat slug should be soldered directly to a multi-layered PCB board to realize the greatest performance. Please refer to application note AN2467 for soldering details.

APPLICATION NOTE

Please refer to application note AN2467 for package information concerning PQFN packages.

See **THERMAL ADDENDUM:**

| Thermal Resistance | Typical Values | Test Condition |
|--------------------|-----------------------------|----------------|
| $R_{\theta JA}$ | Refer to Product Data Sheet | |
| $R_{\theta JA}$ | Refer to Product Data Sheet | |
| $R_{\theta JA}$ | Refer to Product Data Sheet | |

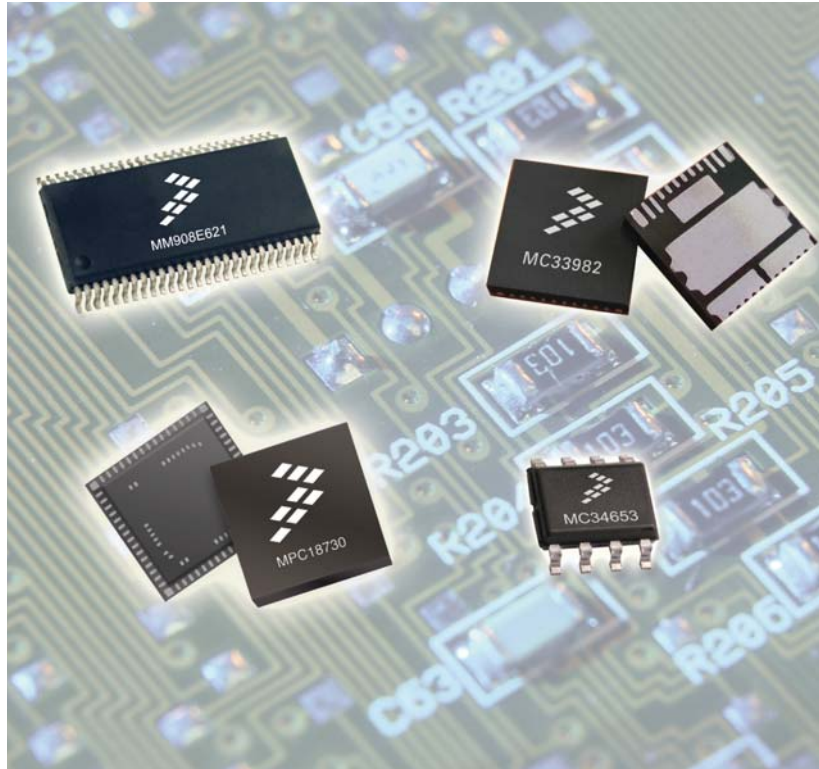

Soldering Footprint:

The Analog and Mixed Signal Products Division of Freescale has a long history of serving the commercial and automotive marketplace, and vast experience with the automotive industry's quality requirements / expectations.

Freescale can provide suggested package footprints for the various package types suitable for the layout of printed circuit assemblies. The information can be requested at www.freescale.com/support by choosing the "Create Service Request" item. First, gather information to place in the service request. On the www.Freescale.com home page, enter the product number into the keyword search box (top right), such as MC33988. Next choose the MC33988 product summary page (.has a html suffix) line item, from the results list. On the product summary page, click on the Buy/Parameter tab. This will provide access to the package drawing information. On the Buy /Parameter page, click on the item in the Package Description and Diagram column (blue text). This will link to a product information web page. Now click on the item in the value column for the Package Description and Mechanical Drawing line item. Note the Document number on the package drawing (document number - 98A.....) that appears. This information along with the product number should be placed in the Request Details Subject and Description blocks for the Customer Service Request. Now go to www.freescale.com/support and choose the "Create Service Request" item, then choose step 1/category - Hardware Product Support and step 2/ topic - Generic Design Questions. Click the Next button. In the Device type selection area, select the product number from the product tree; e.g. Analog & Power Management/Power Actuation/ High side switches/MC33988. Click the Next button. Also, include the information that you are requesting relative to the package solder footprint. Be sure to include the package drawing information gather initially above. Click the Submit button to have your service request submitted.

Learn More: For current information about Freescale products and documentation, please visit www.freescale.com.

Freescale™ and the Freescale logo are trademarks of Freescale Semiconductor, Inc. All other product or service names are the property of their respective owners.

© Freescale Semiconductor, Inc., 2007-2012. All rights reserved.

