

RoHS HQ6025xH5 Series

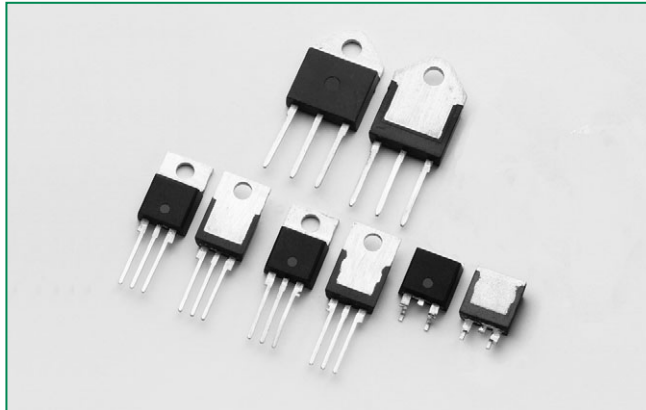

Description

25Amp bi-directional Alternistor Triac is designed for AC switching and phase control applications requiring a higher temperature environment.

Alternistor type devices only operate in quadrants I, II, & and are used in circuits requiring high dv/dt capability.

Features & Benefits

- 150°C maximum junction temperature
- RoHS compliant
- Glass – passivated junctions
- Voltage capability up to 600 V
- Surge capability up to 300 A

Applications

Typically used in high-temperature environments where available heat-sinking is minimal such as heating and white goods applications.

Internally constructed isolated packages are offered for ease of heat sinking with highest isolation voltage.

Agency Approval

Agency	Agency File Number
	L and K Packages: E71639

Main Features

Symbol	Value	Unit
$I_{T(RMS)}$	25	A
V_{DRM}/V_{RRM}	600	V
I_{GT}	50	mA

Schematic Symbol

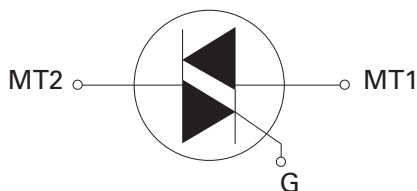

25 A TRIACS

Absolute Maximum Ratings

Symbol	Parameter	Test Conditions		Value	Unit
$I_{T(RMS)}$	RMS on-state current	HQ6025LH5	$T_c = 95^\circ\text{C}$	25	A
		HQ6025RH5 HQ6025NH5 HQ6025KH5	$T_c = 102^\circ\text{C}$		
I_{TSM}	Peak non-repetitive surge current	single half cycle; $f = 50\text{Hz}$; T_J (initial) = 25°C		250	A
		single half cycle; $f = 60\text{Hz}$; T_J (initial) = 25°C		300	
I^2t	I^2t Value for fusing	$t_p = 8.3\text{ms}$		373	A^2s
di/dt	Critical rate-of-rise of on-state current	$f = 60\text{Hz}$; $T_J = 150^\circ\text{C}$		100	$\text{A}/\mu\text{s}$
I_{GTM}	Peak gate current	$T_J = 150^\circ\text{C}$		2	A
$P_{G(AV)}$	Average gate power dissipation	$T_J = 150^\circ\text{C}$		0.5	W
T_{stg}	Storage temperature range			-40 to 150	$^\circ\text{C}$
T_J	Operating junction temperature range			-40 to 150	$^\circ\text{C}$

Electrical Characteristics ($T_J = 25^\circ\text{C}$, unless otherwise specified)

Symbol	Test Conditions	Quadrant		Value	Unit	
I_{GT}	$V_D = 12\text{V}$; $R_L = 60\ \Omega$	I – II – III	MAX.	50	mA	
V_{GT}		I – II – III	MAX.	1.3	V	
V_{GD}	$V_D = V_{DRM}$; $R_L = 3.3\ \text{k}\Omega$; $T_J = 150^\circ\text{C}$	I – II – III	MIN.	0.2	V	
I_H	$I_T = 400\text{mA}$ (initial)			MAX.	80	mA
dv/dt	$V_D = V_{DRM}$; Gate Open; $T_J = 150^\circ\text{C}$			MIN.	350	$\text{V}/\mu\text{s}$
$(dv/dt)_c$	$(di/dt)_c = 13.3\ \text{A/ms}$; $T_J = 150^\circ\text{C}$			MIN.	20	$\text{V}/\mu\text{s}$
t_{gt}	$I_G = 2 \times I_{GT}$; $PW = 15\ \mu\text{s}$; $I_T = 35.4\ \text{A}$			TYP.	3	μs

Static Characteristics

Symbol	Test Conditions			Value	Unit
V_{TM}	$I_T = 35.4\text{A}$; $t_p = 380\ \mu\text{s}$		MAX.	1.4	V
I_{DRM} / I_{RRM}	V_{DRM} / V_{RRM}	$T_J = 25^\circ\text{C}$	MAX.	5	μA
		$T_J = 150^\circ\text{C}$		6000	

Thermal Resistances

Symbol	Parameter	Value	Unit
$R_{\theta(J-C)}$	Junction to case (AC)	HQ6025LH5	2.0
		HQ6025RH5 HQ6025NH5	0.86
		HQ6025KH5	1.35
$R_{\theta(J-A)}$	Junction to ambient	HQ6025LH5	50
		HQ6025RH5	45

Note: xx = voltage

Figure 1: Normalized DC Gate Trigger Current vs. Junction Temperature

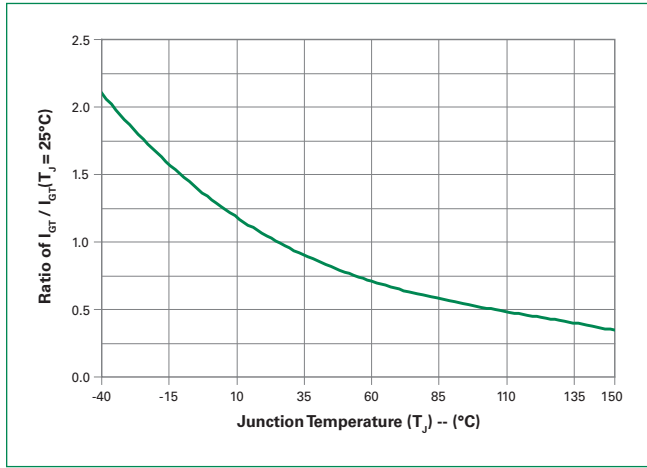

Figure 2: Normalized DC Gate Trigger Voltage vs. Junction Temperature

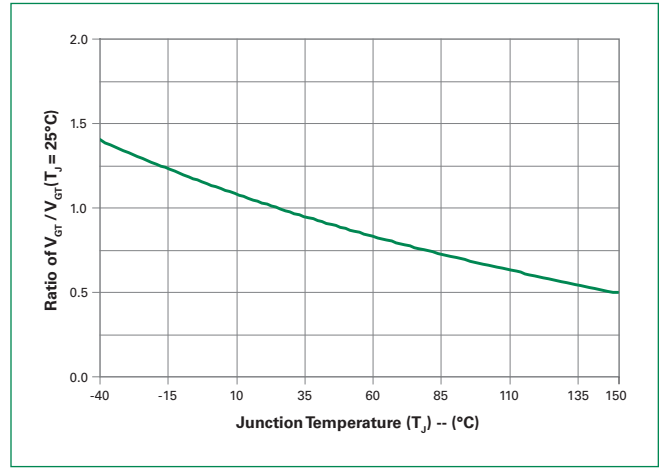

Figure 3: Normalized DC Holding Current vs. Junction Temperature

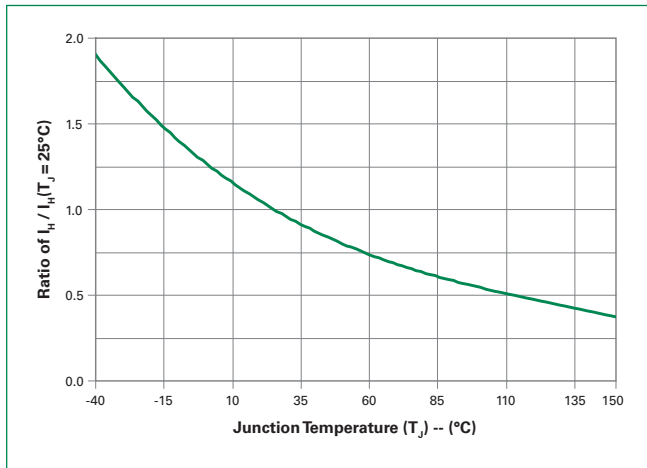

Figure 4: On-State Current vs. On-State Voltage (Typical)

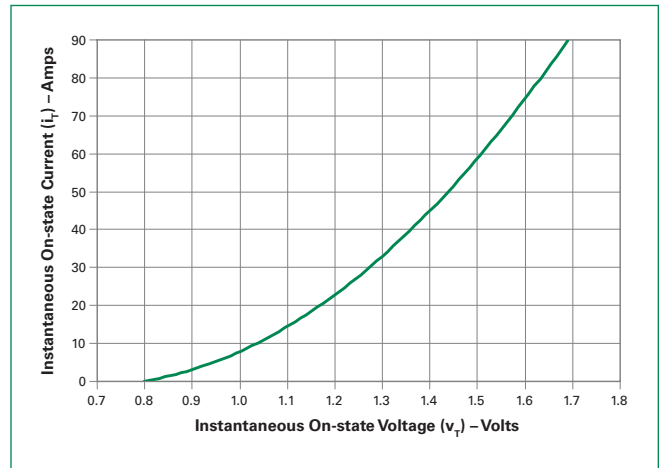

Figure 5: Power Dissipation (Typical) vs. RMS On-State Current

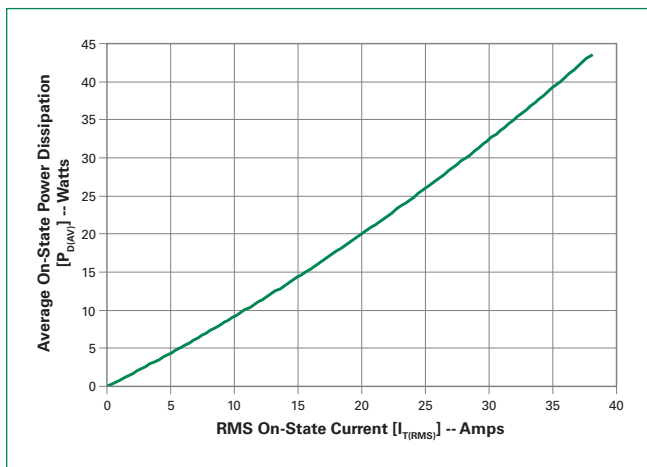

Figure 6: Maximum Allowable Case Temperature vs. RMS On-State Current

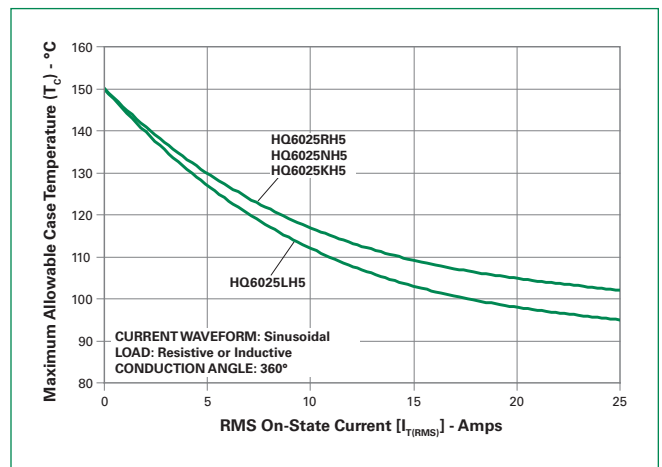

Figure 7: Maximum Allowable Case Temperature vs. Average On-State Current

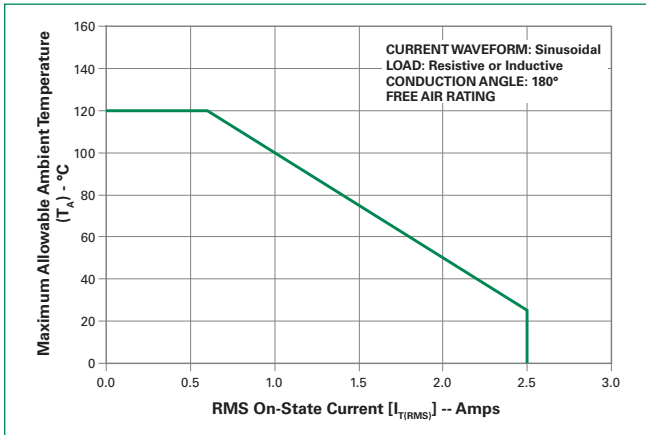
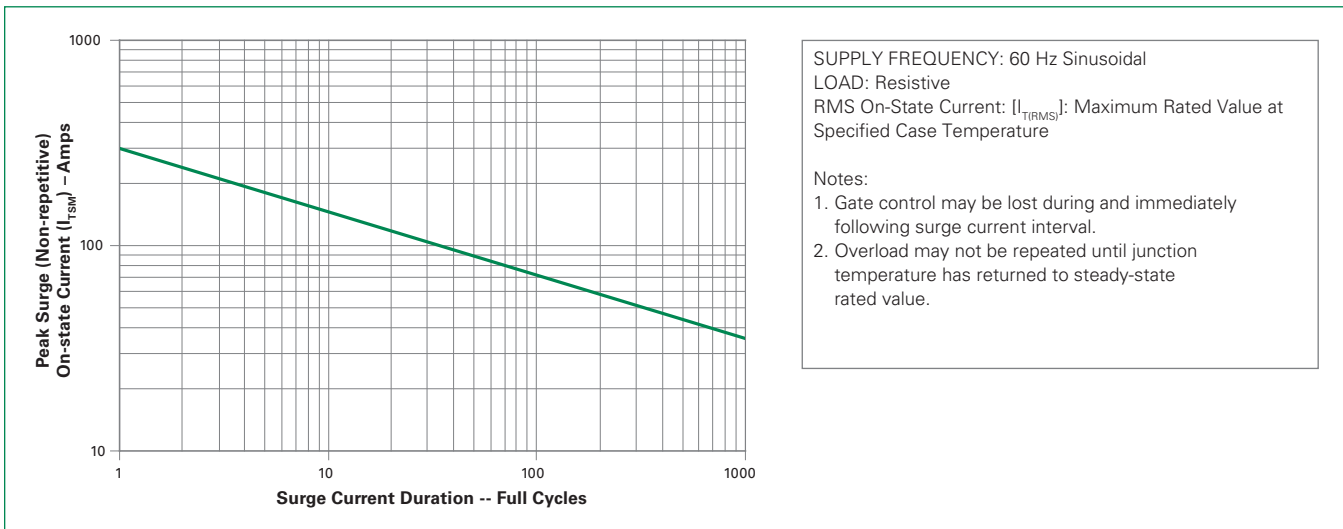
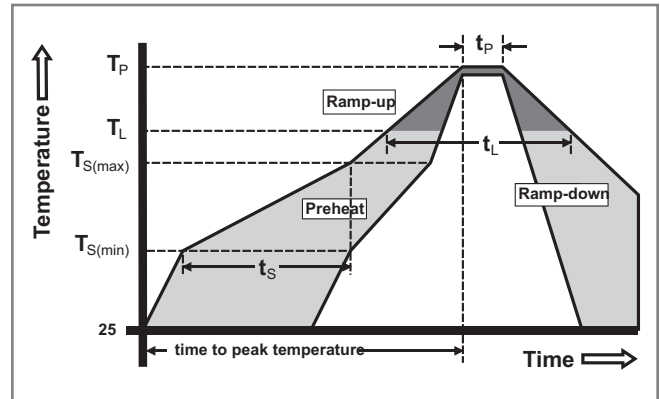

Figure 8: Surge Peak On-State Current vs. Number of Cycles



Soldering Parameters

Reflow Condition		Pb – Free assembly
Pre Heat	- Temperature Min ($T_{s(min)}$)	150°C
	- Temperature Max ($T_{s(max)}$)	200°C
	- Time (min to max) (t_s)	60 – 180 secs
Average ramp up rate (Liquidus Temp (T_L) to peak)		5°C/second max
$T_{s(max)}$ to T_L - Ramp-up Rate		5°C/second max
Reflow	- Temperature (T_L) (Liquidus)	217°C
	- Temperature (t_L)	60 – 150 seconds
Peak Temperature (T_p)		260 ^{+0/-5} °C
Time within 5°C of actual peak Temperature (t_p)		20 – 40 seconds
Ramp-down Rate		5°C/second max
Time 25°C to peak Temperature (T_p)		8 minutes Max.
Do not exceed		280°C



Physical Specifications

Terminal Material	Copper Alloy
Terminal Finish	100% Matte Tin Plated
Body Material	UL recognized epoxy meeting flammability classification 94V-0

Design Considerations

Careful selection of the correct device for the application's operating parameters and environment will go a long way toward extending the operating life of the Thyristor. Good design practice should limit the maximum continuous current through the main terminals to 75% of the device rating. Other ways to ensure long life for a power discrete semiconductor are proper heat sinking and selection of voltage ratings for worst case conditions. Overheating, overvoltage (including dv/dt), and surge currents are the main killers of semiconductors. Correct mounting, soldering, and forming of the leads also help protect against component damage.

Environmental Specifications

Test	Specifications and Conditions
High Temperature Voltage Blocking	MIL-STD-750: Method 1040, Condition A Rated V_{RRM} , 150°C, 1008 hours
Temperature Cycling	MIL-STD-750: Method 1051 -40°C to 150°C, 15-minute dwell, 100 cycles
Biased Temp & Humidity	EIA/JEDEC: JESD22-A101 320VDC, 85°C, 85%RH, 1008 hours
High Temp. Storage	MIL-STD-750: Method 1031 150°C, 1008 hours
Low-Temp Storage	-40°C, 1008 hours
Thermal Shock	MIL-STD-750: Method 1056 0°C to 100°C, 5-minute dwell, 10-second transfer, 10 cycles
Autoclave (Pressure Cooker Test)	EIA/JEDEC: JESD22-A102 121°C, 100%RH, 2atm, 168 hours
Resistance to Solder Heat	MIL-STD-750: Method 2031 260°C, 10 seconds
Solderability	ANSI/J-STD-002, Category 3, Test A
Lead Bend	MIL-STD-750: Method 2036, Condition E

Dimensions — TO-220AB (R-Package) — Non-Isolated Mounting Tab Common with Center Lead

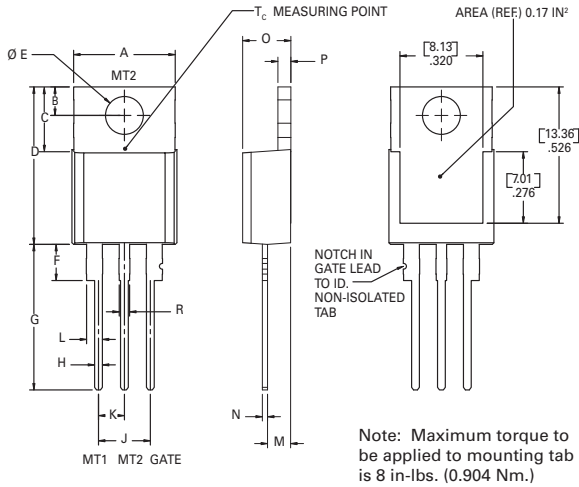

Dimension	Inches		Millimeters	
	Min	Max	Min	Max
A	0.380	0.420	9.65	10.67
B	0.105	0.115	2.67	2.92
C	0.230	0.250	5.84	6.35
D	0.590	0.620	14.99	15.75
E	0.142	0.147	3.61	3.73
F	0.110	0.130	2.79	3.30
G	0.540	0.575	13.72	14.61
H	0.025	0.035	0.64	0.89
J	0.195	0.205	4.95	5.21
K	0.095	0.105	2.41	2.67
L	0.060	0.075	1.52	1.91
M	0.085	0.095	2.16	2.41
N	0.018	0.024	0.46	0.61
O	0.178	0.188	4.52	4.78
P	0.045	0.060	1.14	1.52
R	0.038	0.048	0.97	1.22

Dimensions — TO-220AB (L Package) — Isolated Mounting Tab

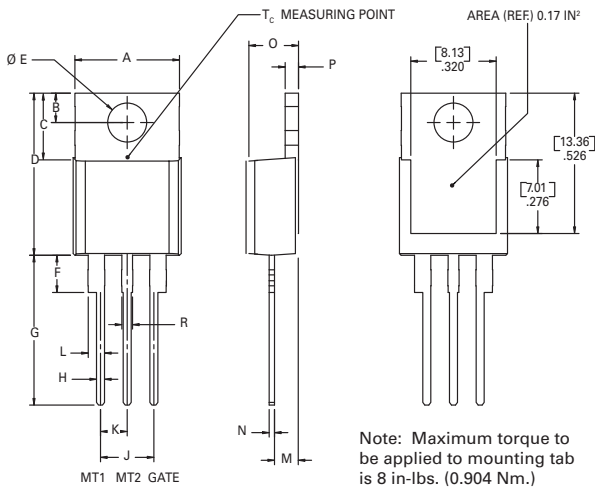

Dimension	Inches		Millimeters	
	Min	Max	Min	Max
A	0.380	0.420	9.65	10.67
B	0.105	0.115	2.67	2.92
C	0.230	0.250	5.84	6.35
D	0.590	0.620	14.99	15.75
E	0.142	0.147	3.61	3.73
F	0.110	0.130	2.79	3.30
G	0.540	0.575	13.72	14.61
H	0.025	0.035	0.64	0.89
J	0.195	0.205	4.95	5.21
K	0.095	0.105	2.41	2.67
L	0.060	0.075	1.52	1.91
M	0.085	0.095	2.16	2.41
N	0.018	0.024	0.46	0.61
O	0.178	0.188	4.52	4.78
P	0.045	0.060	1.14	1.52
R	0.038	0.048	0.97	1.22

Dimensions — TO- 218AC (K Package) — Isolated Mounting Tab

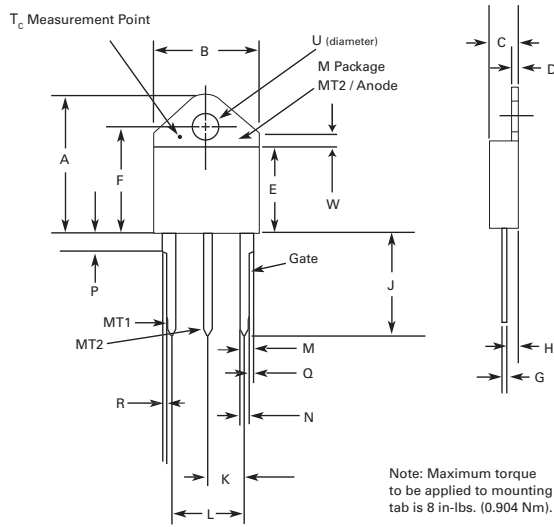

Dimension	Inches		Millimeters	
	Min	Max	Min	Max
A	0.810	0.835	20.57	21.21
B	0.610	0.630	15.49	16.00
C	0.178	0.188	4.52	4.78
D	0.055	0.070	1.40	1.78
E	0.487	0.497	12.37	12.62
F	0.635	0.655	16.13	16.64
G	0.022	0.029	0.56	0.74
H	0.075	0.095	1.91	2.41
J	0.575	0.625	14.61	15.88
K	0.211	0.219	5.36	5.56
L	0.422	0.437	10.72	11.10
M	0.058	0.068	1.47	1.73
N	0.045	0.055	1.14	1.40
P	0.095	0.115	2.41	2.92
Q	0.008	0.016	0.20	0.41
R	0.008	0.016	0.20	0.41
U	0.159	0.163	4.04	4.14
W	0.085	0.095	2.17	2.42

25 A TRIACS

Dimensions — TO-263AB (N-Package) — D² -PAK Surface Mount

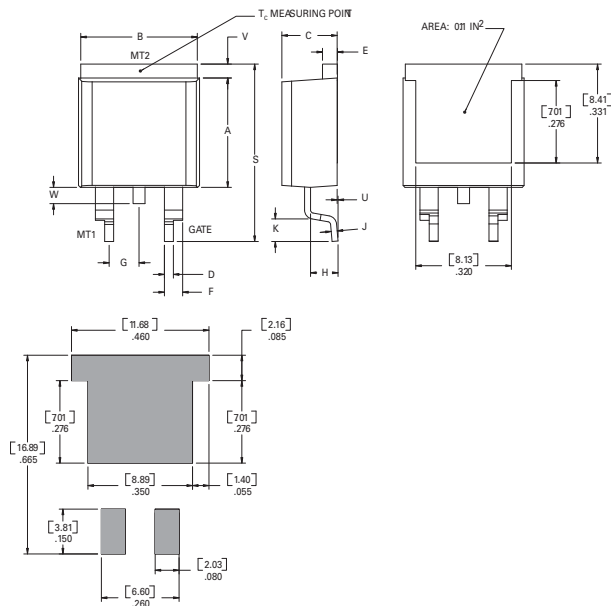

Dimension	Inches		Millimeters	
	Min	Max	Min	Max
A	0.360	0.370	9.14	9.40
B	0.380	0.420	9.65	10.67
C	0.178	0.188	4.52	4.78
D	0.025	0.035	0.64	0.89
E	0.045	0.060	1.14	1.52
F	0.060	0.075	1.52	1.91
G	0.095	0.105	2.41	2.67
H	0.092	0.102	2.34	2.59
J	0.018	0.024	0.46	0.61
K	0.090	0.110	2.29	2.79
S	0.590	0.625	14.99	15.88
V	0.035	0.045	0.89	1.14
U	0.002	0.010	0.05	0.25
W	0.040	0.070	1.02	1.78

Product Selector

Part Number	Voltage				Gate Sensitivity	Package
	400V	600V	800V	1000V		
HQ6025RH5		X			50 mA	TO-220R
HQ6025NH5		X			50 mA	TO-263
HQ6025LH5		X			50 mA	TO-220L
HQ6025KH5		X			50 mA	TO-218K

Packing Options

Part Number	Marking	Weight	Packing Mode	Base Quantity
HQ6025RH5	HQ6025RH5	2.2g	Bulk	500
HQ6025RH5TP	HQ6025RH5	2.2g	Tube	500 (50 per tube)
HQ6025NH5TP	HQ6025NH5	1.6g	Tube	500 (50 per tube)
HQ6025NH5RP	HQ6025NH5	1.6g	Embossed Carrier	500
HQ6025LH5TP	HQ6025LH5	2.2g	Tube	500 (50 per tube)
HQ6025KH5TP	HQ6025KH5	4.4g	Tube	250 (25 per tube)

TO-263 Embossed Carrier Reel Pack (RP) Specifications

Meets all EIA-481-2 Standards

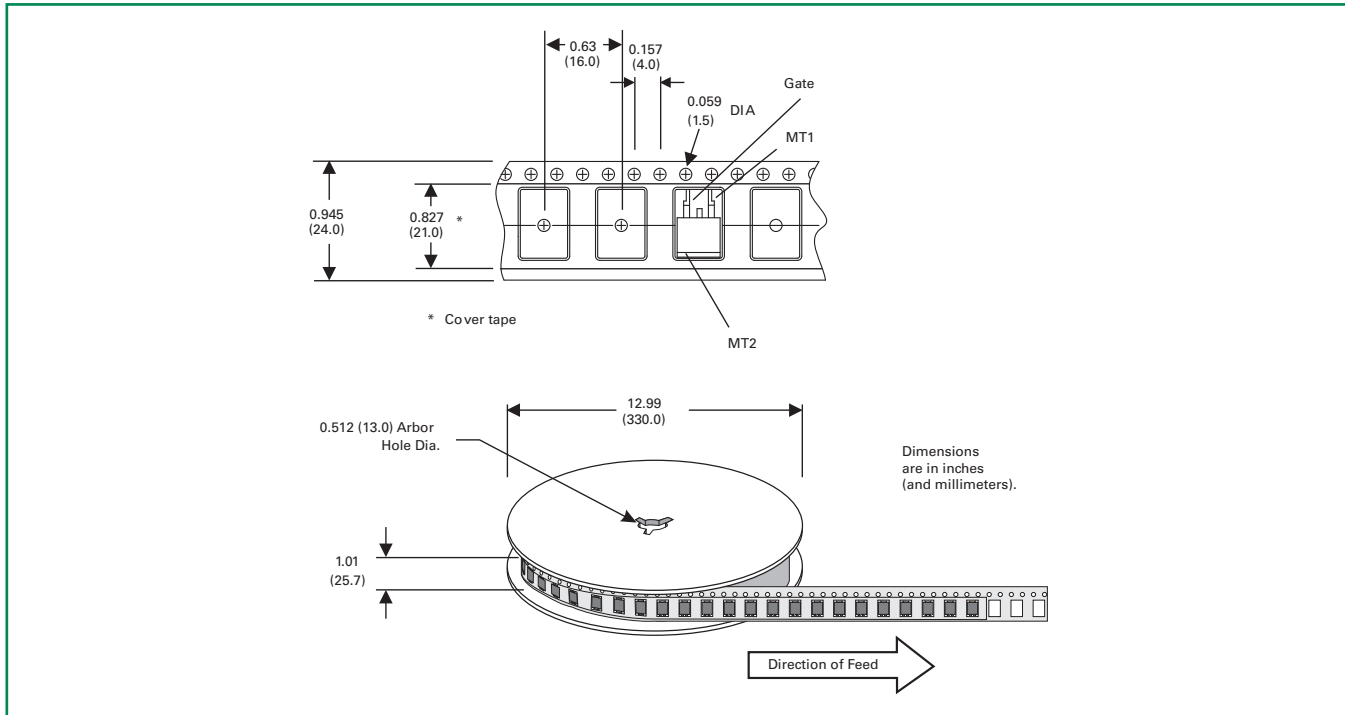

Part Numbering System

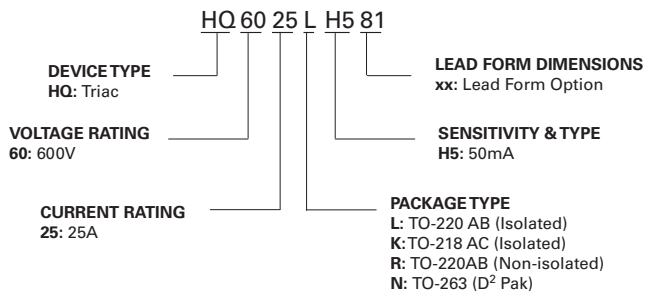

Part Marking System

TO-220AB (R and L Packages) TO-218AC (K Package)
TO-263 (N Package)

