

**RoHS SIDACTor® Primary Protection Balanced Series - Modified TO-220**

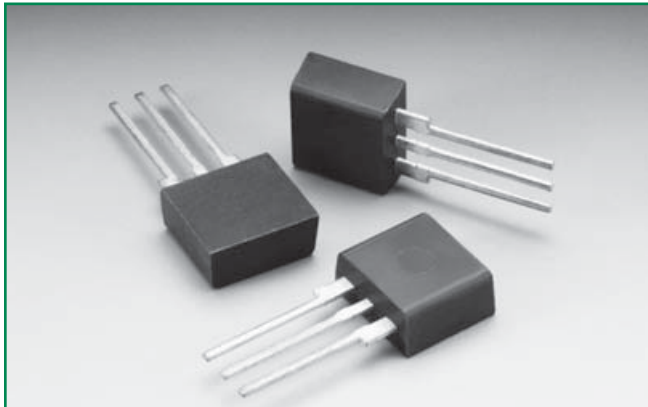

**Description**

The SIDACTor® Primary Protection Balanced Series Modified TO-220 are thyristor devices designed for use in primary protection applications.

The series provides a single port overvoltage solution that enables applications to comply with the balance requirements of GR-974 and GTS-8700. Please contact Littelfuse to discuss your particular application and regulatory requirements.

**Features and Benefits**

- High holding current options available
- Does not degrade with use
- Balanced overvoltage protection
- Fails short circuit when surged in excess of ratings
- Failsafe option available
- Single-port protection
- Low voltage overshoot
- Modified TO-220 Package
- Low on-state voltage
- Lead forms available

**Applicable Global Standards**

- GR-974
- GTS-8700
- UL 497
- ITU K.28

**Agency Approvals**

Agency	Agency File Number
	E133083

**Pinout Designation**

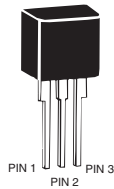

**Schematic Symbol**

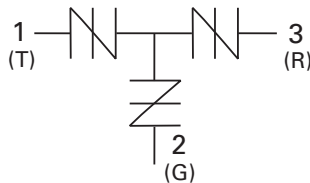

**Electrical Characteristics**

Part Number	Marking	$V_{DRM}$ @ $I_{DRM}=5\mu A$		$V_S$ @ 100V/ $\mu s$	$I_H^*$	$I_S$	$I_T$	$V_T @ I_T=2.2$ Amps	Capacitance			
		V min		V max	mA min	mA max	A max	V max	Pin 1-2 / 3-2 Tip-Ground, Ring-Ground		Pin 1-3 Tip-Ring	
		Pins 1-2, 3-2, 1-3								pF min	pF max	pF min
P1553ACLxx	P1553AC	130	180	150	800	2.2	8	8	65	95	40	60
P1803ACLxx	P1803AC	150	210	150	800	2.2	8	8	55	85	35	55
P2103ACLxx	P2103AC	170	250	150	800	2.2	8	8	55	85	30	55
P2353ACLxx	P2353AC	200	270	150	800	2.2	8	8	50	75	30	50
P2703ACLxx	P2703AC	230	300	150	800	2.2	8	8	50	75	30	50
P3203ACLxx	P3203AC	270	350	150	800	2.2	8	8	45	70	25	45
P3403ACLxx	P3403AC	300	400	150	800	2.2	8	8	45	65	25	45
P5103ACLxx	P5103AC	420	600	150	800	2.2	8	8	40	60	20	40

Notes:

- \* Higher holding current available by special order. Contact Littelfuse for additional information.
- Absolute maximum ratings measured at  $T_c = 25^\circ C$  (unless otherwise noted).
- Devices are bi-directional (unless otherwise noted).

- Off-state capacitance ( $C_o$ ) is measured at 1 MHz with a 2 V bias.
- **xx** Part Number Suffix: '**RP**' (Reel pack), '**Blank**' (Bulk pack), '**60**' (Type 60 lead form bulk pack), '**FS1**' (Failsafe option bulk pack). Refer to Part Numbering section for additional details.

**Surge Ratings**

Series	$I_{PP}$									$I_{TSM}$ 50/60 Hz	di/dt
	$0.2 \times 310^1$ $0.5 \times 700^2$	$2 \times 10^1$ $2 \times 10^2$	$8 \times 20^1$ $1.2 \times 50^2$	$10 \times 160^1$ $10 \times 160^2$	$10 \times 560^1$ $10 \times 560^2$	$5 \times 320^1$ $9 \times 720^2$	$10 \times 360^1$ $10 \times 360^2$	$10 \times 1000^1$ $10 \times 1000^2$	$5 \times 310^1$ $10 \times 700^2$		
	A min	A min	A min	A min	A min	A min	A min	A min	A min		
C	50	500	400	200	150	200	175	100	200	50	500

Notes:

- 1 Current waveform in  $\mu s$
- 2 Voltage waveform in  $\mu s$
- Peak pulse current rating ( $I_{PP}$ ) is repetitive and guaranteed for the life of the product.
- $I_{PP}$  ratings applicable over temperature range of  $-40^\circ C$  to  $+85^\circ C$
- The device must initially be in thermal equilibrium with  $-40^\circ C \leq T_j \leq +150^\circ C$

**Thermal Considerations**

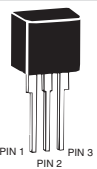
Package	Symbol	Parameter	Value	Unit
Modified TO-220 	$T_J$	Operating Junction Temperature Range	-40 to +150	$^\circ C$
	$T_S$	Storage Temperature Range	-65 to +150	$^\circ C$
	$R_{\theta JA}$	Thermal Resistance: Junction to Ambient	50	$^\circ C/W$

**V-I Characteristics**

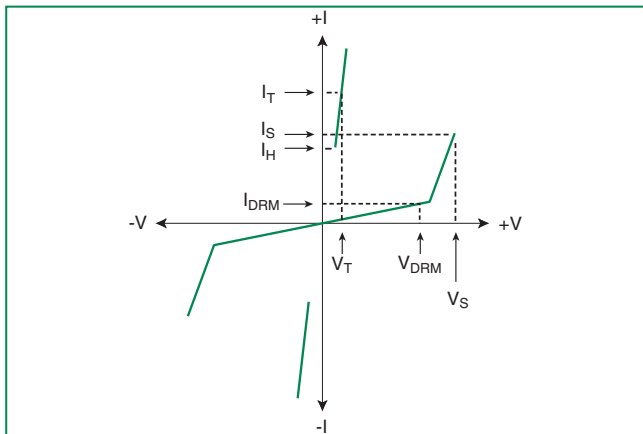

**$t_r \times t_d$  Pulse Waveform**

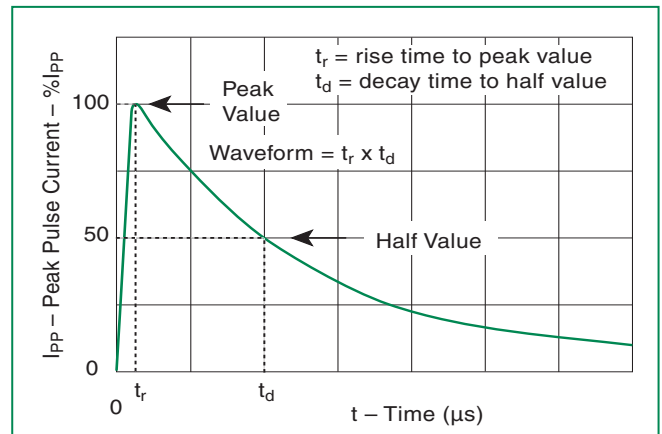

**Normalized  $V_S$  Change vs. Junction Temperature**

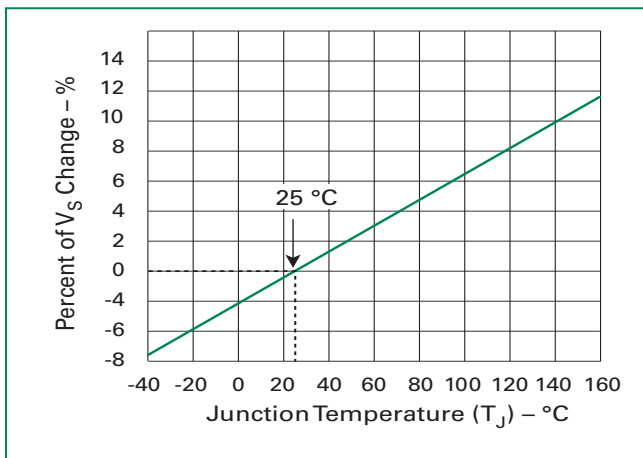

**Normalized DC Holding Current vs. Case Temperature**

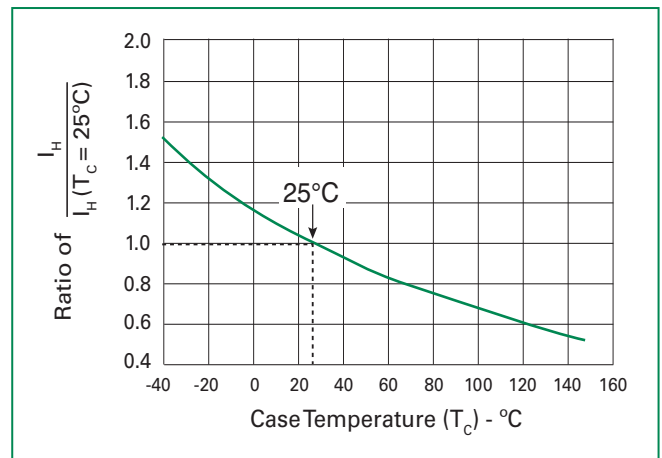

**Soldering Parameters**

Reflow Condition		Pb-Free assembly (see Fig. 1)
Pre Heat	-Temperature Min ( $T_{s(min)}$ )	+150°C
	-Temperature Max ( $T_{s(max)}$ )	+200°C
	-Time (Min to Max) ( $t_s$ )	60-180 secs.
Average ramp up rate (Liquidus Temp ( $T_L$ ) to peak)		3°C/sec. Max.
$T_{s(max)}$ to $T_L$ - Ramp-up Rate		3°C/sec. Max.
Reflow	-Temperature ( $T_L$ ) (Liquidus)	+217°C
	-Temperature ( $t_L$ )	60-150 secs.
Peak Temp ( $T_p$ )		+260(+0/-5)°C
Time within 5°C of actual PeakTemp ( $t_p$ )		30 secs. Max.
Ramp-down Rate		6°C/sec. Max.
Time 25°C to PeakTemp ( $T_p$ )		8 min. Max.
Do not exceed		+260°C

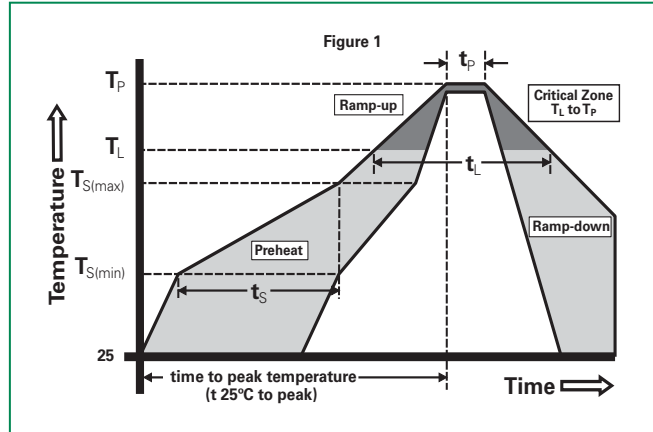

**Physical Specifications**

<b>Lead Material</b>	Copper Alloy
<b>Terminal Finish</b>	100% Matte-Tin Plated
<b>Body Material</b>	UL recognized epoxy meeting flammability classification 94V-0

**Environmental Specifications**

<b>High Temp Voltage Blocking</b>	80% Rated $V_{DRM}$ ( $V_{AC Peak}$ ) +125°C or +150°C, 504 or 1008 hrs. MIL-STD-750 (Method 1040) JEDEC, JESD22-A-101
<b>Temp Cycling</b>	-65°C to +150°C, 15 min. dwell, 10 up to 100 cycles. MIL-STD-750 (Method 1051) EIA/JEDEC, JESD22-A104
<b>Biased Temp &amp; Humidity</b>	52 $V_{DC}$ (+85°C) 85%RH, 504 up to 1008 hrs. EIA/JEDEC, JESD22-A-101
<b>High Temp Storage</b>	+150°C 1008 hrs. MIL-STD-750 (Method 1031) JEDEC, JESD22-A-101
<b>Low Temp Storage</b>	-65°C, 1008 hrs.
<b>Thermal Shock</b>	0°C to +100°C, 5 min. dwell, 10 sec. transfer, 10 cycles. MIL-STD-750 (Method 1056) JEDEC, JESD22-A-106
<b>Autoclave (Pressure Cooker Test)</b>	+121°C, 100%RH, 2atm, 24 up to 168 hrs. EIA/JEDEC, JESD22-A-102
<b>Resistance to Solder Heat</b>	+260°C, 30 secs. MIL-STD-750 (Method 2031)
<b>Moisture Sensitivity Level</b>	85%RH, +85°C, 168 hrs., 3 reflow cycles (+260°C Peak). JEDEC-J-STD-020, Level 1

**Part Numbering**

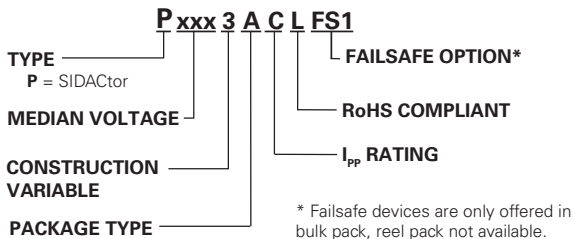
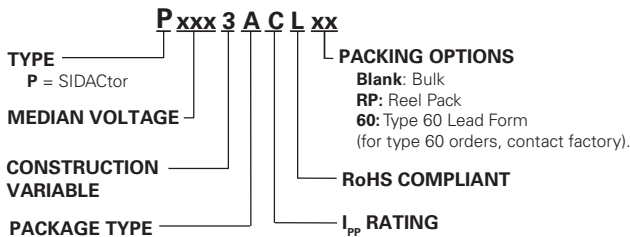

**Part Marking**

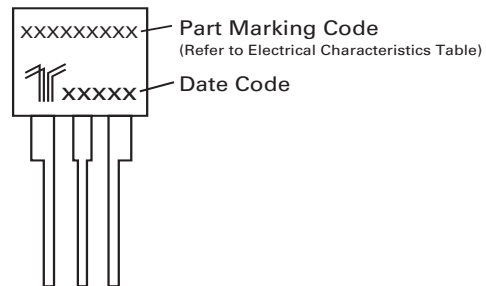

Primary Protection Series

**Dimensions - Modified TO-220**

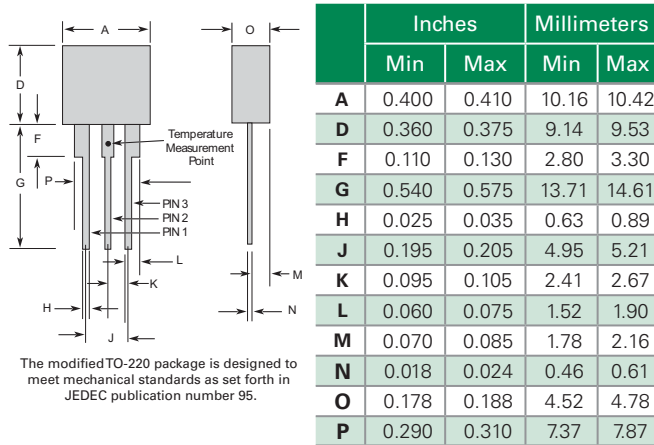

**Dimensions - Modified TO-220 with Failsafe**

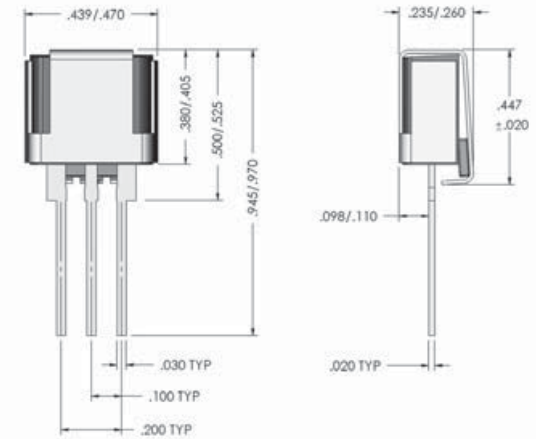

**Tape and Reel Specification - Modified TO-220**

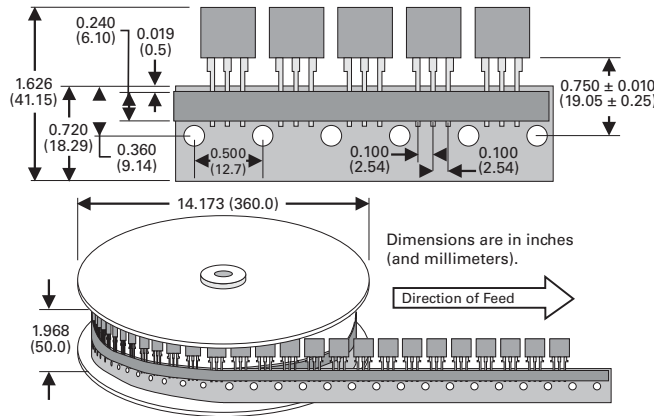

**Dimensions - Modified TO-220 Type 60 with Failsafe**

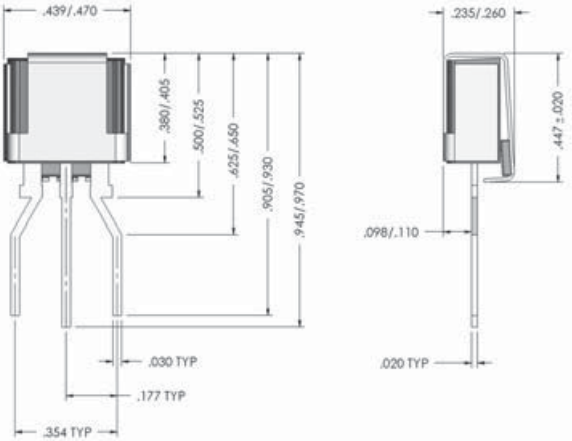

**Packing Options**

Package Type	Description	Quantity	Added Suffix	Industry Standard
A	Modified TO-220 Tape and Reel Pack	700	RP	EIA-468-B
	Modified TO-220 Bulk Pack	500	(no added suffix)	N/A
	Modified TO-220 Type 60 Lead Form Bulk Pack	500	60 (special order item, contact factory for details)	N/A