

PTC Thermistor (POSISTOR®)

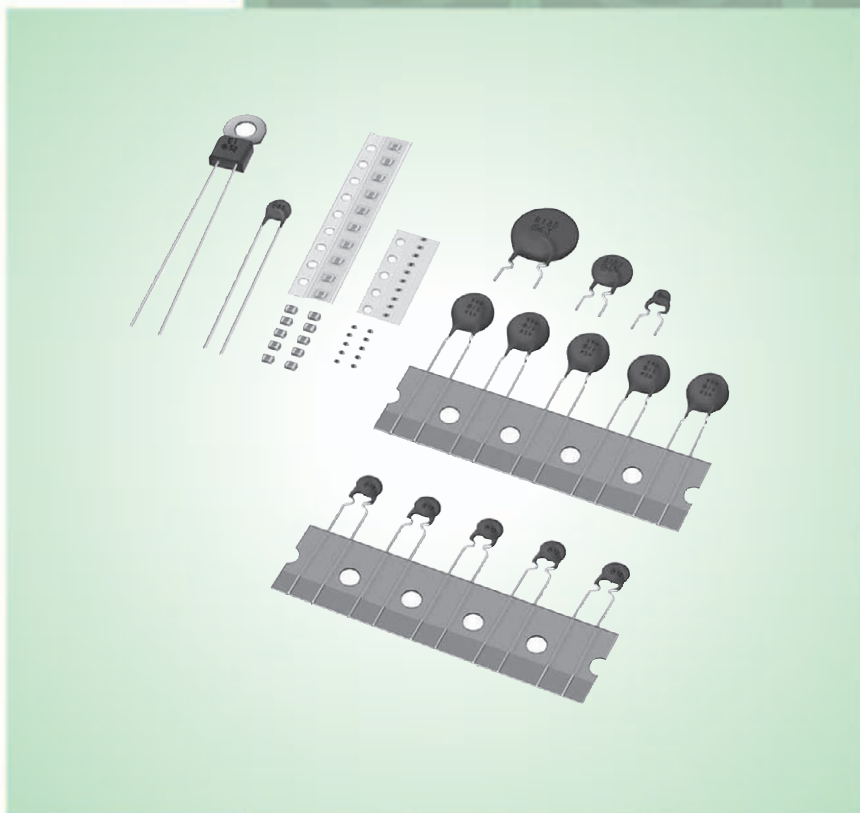

Application Manual

muRata

*Innovator
in Electronics*

Murata
Manufacturing Co., Ltd.

for EU RoHS Compliant

- All the products on this catalog are complied with EU RoHS.
- EU RoHS is "the European Directive 2011/65/EC on the Restriction of the Use of Certain Hazardous Substances in Electrical and Electronic Equipment".
- For more details, please refer to our website 'Murata's Approach for EU RoHS' (<http://www.murata.com/info/rohs.html>).

POSISTOR® Application and Variety List	2
1 Characteristics of POSISTOR®	3
1. Introduction	3
2. Characteristics of POSISTOR®	3
2 The basic design data	4
1. Resistance - temperature characteristics	4
2. Voltage - current characteristics (Static characteristics)	5
3. Current - time characteristics (Dynamic characteristics)	6
3 Structure of POSISTOR®	7
4 Practical applications of POSISTOR®	8
1. For temperature sensor and temperature compensation	8
2. For current control	10
5 Terms	11
■Strict observance	11
■Notice	11

POSISTOR® and "POSISTOR" in this manual are the trademarks of Murata Manufacturing Co., Ltd.

CONTENTS

1	Characteristics of POSISTOR®
2	The basic design data
3	Structure of POSISTOR®
4	Practical applications of POSISTOR®
5	Terms

POSISTOR® Application and Variety List

Application Target device		Over current Protection		Overheat Sensing	
		Chip type PRG	Lead type PTGL	Chip type PRF	Lead type PTFM
AV equipment	Plasma TV	<input type="checkbox"/>	<input type="checkbox"/>	<input type="checkbox"/>	<input type="checkbox"/>
	LCD TV	<input type="checkbox"/>	<input type="checkbox"/>	<input type="checkbox"/>	<input type="checkbox"/>
	Projection TV	<input type="checkbox"/>	<input type="checkbox"/>	<input type="checkbox"/>	<input type="checkbox"/>
	CATV		<input type="checkbox"/>		
	STB		<input type="checkbox"/>		
	Video camera	<input type="checkbox"/>		<input type="checkbox"/>	
	Digital camera	<input type="checkbox"/>		<input type="checkbox"/>	
	DVD recorder	<input type="checkbox"/>		<input type="checkbox"/>	
	VTR	<input type="checkbox"/>	<input type="checkbox"/>	<input type="checkbox"/>	
	Audio	<input type="checkbox"/>	<input type="checkbox"/>	<input type="checkbox"/>	<input type="checkbox"/>
	Electric keyboard, Electronic music instrument	<input type="checkbox"/>	<input type="checkbox"/>	<input type="checkbox"/>	<input type="checkbox"/>
	Digital mobile audio	<input type="checkbox"/>		<input type="checkbox"/>	
	MD/CD player	<input type="checkbox"/>		<input type="checkbox"/>	
	TV game	<input type="checkbox"/>	<input type="checkbox"/>	<input type="checkbox"/>	
Portable game	<input type="checkbox"/>		<input type="checkbox"/>		
Information equipment	Laptop	<input type="checkbox"/>		<input type="checkbox"/>	
	Desktop computer	<input type="checkbox"/>		<input type="checkbox"/>	
	Server	<input type="checkbox"/>	<input type="checkbox"/>	<input type="checkbox"/>	<input type="checkbox"/>
	Printer	<input type="checkbox"/>	<input type="checkbox"/>	<input type="checkbox"/>	<input type="checkbox"/>
	Scanner	<input type="checkbox"/>		<input type="checkbox"/>	
	LCD display	<input type="checkbox"/>	<input type="checkbox"/>	<input type="checkbox"/>	<input type="checkbox"/>
	USB access device	<input type="checkbox"/>		<input type="checkbox"/>	
	HDD			<input type="checkbox"/>	
	CD/DVD-ROM/RAM			<input type="checkbox"/>	
	Copy machine	<input type="checkbox"/>	<input type="checkbox"/>	<input type="checkbox"/>	<input type="checkbox"/>
	Electronic dictionary/databook	<input type="checkbox"/>		<input type="checkbox"/>	
	Electronic blackboard	<input type="checkbox"/>	<input type="checkbox"/>	<input type="checkbox"/>	<input type="checkbox"/>
Communications equipment	Electronic automatic exchange		<input type="checkbox"/>		
	Transmission equipment		<input type="checkbox"/>		
	PBX		<input type="checkbox"/>		
	Cordless telephone		<input type="checkbox"/>		
	Fax machine	<input type="checkbox"/>	<input type="checkbox"/>	<input type="checkbox"/>	<input type="checkbox"/>
	Modem		<input type="checkbox"/>		
	Cellular phone	<input type="checkbox"/>		<input type="checkbox"/>	
	Headset			<input type="checkbox"/>	
	Cellular phone base station	<input type="checkbox"/>		<input type="checkbox"/>	<input type="checkbox"/>
Intercom	<input type="checkbox"/>	<input type="checkbox"/>			
Car electronics	Engine control ECU	<input type="checkbox"/>		<input type="checkbox"/>	
	Drive control ECU	<input type="checkbox"/>		<input type="checkbox"/>	
	Air-bag	<input type="checkbox"/>			
	Anticollision radar			<input type="checkbox"/>	
	ABS/ESC	<input type="checkbox"/>		<input type="checkbox"/>	
	Instrument/display panel, Meter			<input type="checkbox"/>	
	Rechargeable battery for EV/HEV		<input type="checkbox"/>	<input type="checkbox"/>	
	Car air conditioner			<input type="checkbox"/>	
	Heater, HVAC			<input type="checkbox"/>	
	HID/LED headlight, AFS	<input type="checkbox"/>	<input type="checkbox"/>	<input type="checkbox"/>	
	LED tail light	<input type="checkbox"/>	<input type="checkbox"/>	<input type="checkbox"/>	
	LED interior light	<input type="checkbox"/>		<input type="checkbox"/>	
	Retractable electric mirror		<input type="checkbox"/>		
	Door lock, trunk opener		<input type="checkbox"/>		
	Power seat		<input type="checkbox"/>		
	Shock absorber		<input type="checkbox"/>		
	VICS, ETC			<input type="checkbox"/>	
Burglar alarm	<input type="checkbox"/>	<input type="checkbox"/>			
Car navigation	<input type="checkbox"/>	<input type="checkbox"/>	<input type="checkbox"/>		
Car audio	<input type="checkbox"/>	<input type="checkbox"/>	<input type="checkbox"/>	<input type="checkbox"/>	
Home electronics Household equipment	Refrigerator	<input type="checkbox"/>	<input type="checkbox"/>	<input type="checkbox"/>	
	Microwave, Oven	<input type="checkbox"/>	<input type="checkbox"/>	<input type="checkbox"/>	
	Electric rice-cooker		<input type="checkbox"/>	<input type="checkbox"/>	
	IH cooking device		<input type="checkbox"/>	<input type="checkbox"/>	
	Air conditioner	<input type="checkbox"/>	<input type="checkbox"/>	<input type="checkbox"/>	
	Fan heater			<input type="checkbox"/>	<input type="checkbox"/>
	Cleaner		<input type="checkbox"/>	<input type="checkbox"/>	
	Bath dryer				
	Clothes washer, cloth dryer		<input type="checkbox"/>		
	Futon dryer				
	Hot-air heater				
	Electric pot				
	Ventilator		<input type="checkbox"/>		
	hot-water pot		<input type="checkbox"/>	<input type="checkbox"/>	<input type="checkbox"/>
	Humidifying device				
	Inhaler				
	Illumination device	<input type="checkbox"/>	<input type="checkbox"/>	<input type="checkbox"/>	<input type="checkbox"/>
	Massage chair, healthcare equipment	<input type="checkbox"/>	<input type="checkbox"/>	<input type="checkbox"/>	<input type="checkbox"/>
	Curling iron				
	Potable compact iron				
Hot water spray toilet seat			<input type="checkbox"/>	<input type="checkbox"/>	
Electric power tool	<input type="checkbox"/>	<input type="checkbox"/>	<input type="checkbox"/>	<input type="checkbox"/>	
Electric mosquito extermination, fragrance device					
Power supply	Switching supply	<input type="checkbox"/>	<input type="checkbox"/>	<input type="checkbox"/>	<input type="checkbox"/>
	Inverter power	<input type="checkbox"/>	<input type="checkbox"/>	<input type="checkbox"/>	<input type="checkbox"/>
	AC adapter, battery charger	<input type="checkbox"/>	<input type="checkbox"/>	<input type="checkbox"/>	<input type="checkbox"/>

1 Characteristics of POSISTOR®

1. Introduction

Barium titanate (BaTiO₃) is a ferroelectric substance that was first identified in 1944. Its resistivity at room temperature becomes an n-type controlled-valency semiconductor with 1-10⁶ohm · cm, if a slight amount of rare earth elements are added to Barium titanate. It was first made in 1951. Murata was extremely interested in this semiconductor and successfully starting the first commercial production of the POSISTOR in 1961.

Since then, it has been applied to several applications under the name of POSISTOR.

POSISTOR is Positive Temperature Coefficient Thermistor (PTC Thermistor). Normally when the temperature increases, the resistance of conventional Thermistor decreases. But, the resistance of PTC Thermistor rises sharply when its temperature exceeds a specific temperature.

2. Characteristics of the POSISTOR®

Basically, the POSISTOR increases its resistance value, when its temperature rises. From this phenomenon,

three characteristics can be made, which are described below.

■ Table 1 Characteristics of POSISTOR

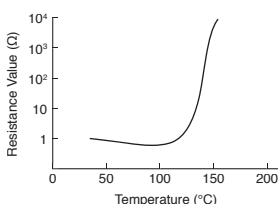
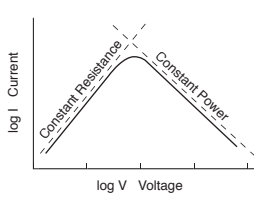
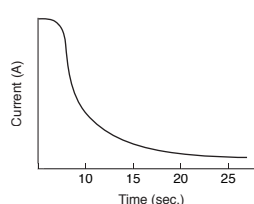
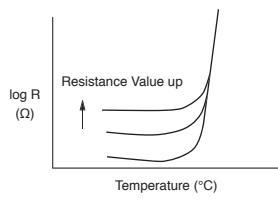
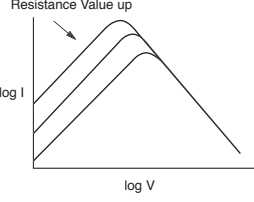
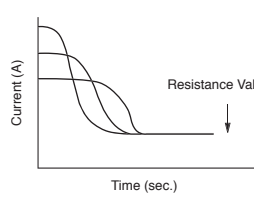
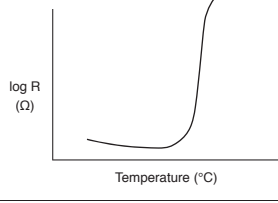
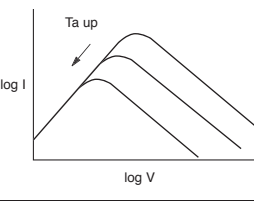
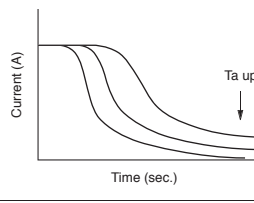
	Resistance - temperature characteristics (time independent)	Voltage - current characteristics (Static Characteristic, time independent)	Current - time characteristics (Dynamic characteristic, time dependent)
Basic characteristics			
Resistance at 25degC			
Ambient temperature (Ta)			
Features	Temperature change can be detected because the resistance of POSISTOR is changed by ambient temperature.	This characteristic shows the relation between the applied voltage and stable current, when the Thermistor internal self-heating equals the heat dissipated by the Thermistor to the outside (state of equilibrium). Each above chart is composed of constant resistance area, maximum current point and constant power area.	This characteristic shows the relation between current and time as equilibrium is achieved between internal self-heating and heat dissipation under the applied voltage.
Functions & applications	<ol style="list-style-type: none"> 1. Temperature sensing, temperature compensation 2. Overheat protection of electric equipment, electric devices, Heater devices, Power supplies. Power IC/ FET 	<ol style="list-style-type: none"> 1. Current control, over current protection 2. Constant temperature heater 3. Detector element using change of heat dissipation factor 4. Constant voltage and constant current equipment 	<ol style="list-style-type: none"> 1. Motor starter element (Motor starter relay) 2. Timer delay element

1

2 The basic design data

1. Resistance - temperature characteristics

The POSISTOR® has resistance - temperature characteristics that cause its resistance to exponentially increase when the part's temperature exceeds its Curie-point (Cp), the critical temperature where the resistance value increases dramatically. Typically above the Cp, the resistance of POSISTOR increase at rate of 15% to 60% per degC. There are many kinds of Cp available (from 40degC to 280degC, as shown in Fig. 1, table 2 and table 3) which allows for the easy selection of a suitable Cp for each application.

Some special POSISTOR, products with a Cp below room temperature, exhibit a more linear rate of resistance increase of 5% per degC, above its Cp. If a resistor is connected with the POSISTOR in series or parallel, the resistance - temperature characteristics

can be changed as shown in Fig. 2 and Fig. 3. In the case where a POSISTOR is used for temperature compensation, of a transistor for example, this method is useful to obtain suitable temperature characteristics.

■Table 3 Temp. Characteristics (T.C.) and Cp

T.C.	Cp (degC)	T.C.	Cp (degC)
AD	280	BA	110
AE	260	BB	100
AF	240	BC	90
AG	220	BD	80
AH	200	BE	70
AK	180	BF	60
AL	170	BG	50
AM	160	BH	40
AN	150	T	(-50)
AP	140		
AS	130		
AR	120		

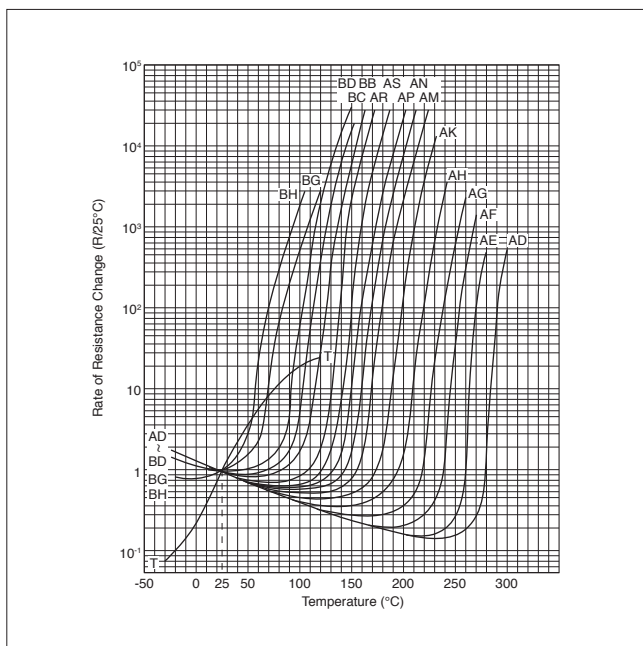

Fig. 1

■Table 2 Resistance - temperature characteristics

Classification	Temperature characteristics	Description of characteristics	Applications
(i)	T	Exhibits a generally uniform positive resistance temperature characteristics (about 5%/degC) within the temperature range of room temperature to 60degC	Temp. compensation, Temp. sensing
(ii)	BH-AR	Exhibits an almost linear resistance increase between room temp and the Cp, with an abrupt resistance increase above the Cp. Cp is available in a range from 40degC to 120degC, selected by temperature characteristics	Temp. sensing, Overheat sensing, Motor starting, Heaters
(iii)	AR-AD	Exhibits a less than linear resistance increase from room temperature to the Cp, with an abrupt resistance rise over the Cp.	Temp. sensing, Overheat sensing, Over current protection, Motor starting, Heaters

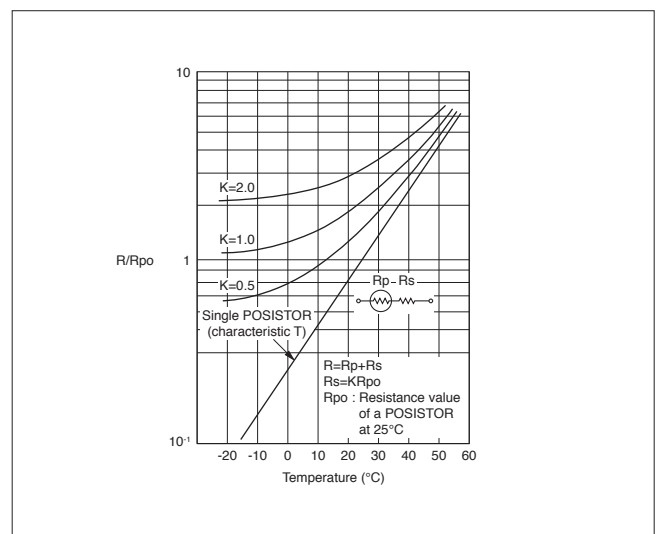

Fig. 2 Insertion of fixed resistance in series with POSISTOR

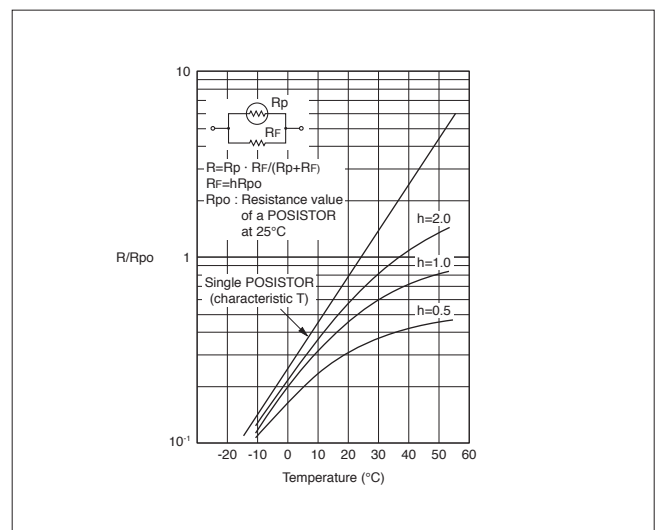

Fig. 3 Insertion of fixed resistance in parallel with POSISTOR

2. Voltage - current characteristics (Static characteristics)

The POSISTOR® can be used as a constant temperature heater with an automatic temperature adjustment function and can maintain constant wattage, even over voltage fluctuation, if the current through the POSISTOR is maintained above its maximum current point.

The POSISTOR can provide over-current protection if it is connected in series in a circuit. If current through the POSISTOR is less than the maximum current point provided as “protective current” in the spec, the POSISTOR acts like a regular fixed value resistor. If current exceeds the protective current, the POSISTOR will sharply increase in resistance due to self heating and reduce the current flow, providing protection to the rest of the circuit.

By adding a series or parallel resistor to the POSISTOR, the voltage-current characteristics can be changed as shown in Fig. 5. As an example, a resistor in parallel with the POSISTOR can provide a constant current function with increasing voltage (see curves 1, 2, and 3 in Fig. 5.)

When voltage is applied to the POSISTOR, self-heating can occur due to current flow. If current flow through the POSISTOR, exceeds the maximum current point, then self heating of the POSISTOR may cause the temperature of the part to exceed the CP and its resistance raises dramatically. As long as the maximum current point is exceeded, the POSISTOR will stabilize above the Cp and high resistance will be maintained. As current is reduced below the maximum current point, self heating is reduced and the POSISTOR will cool to below the Cp, assuming an external heat source is not present.

With the voltage - current characteristics shown in a double logarithmic graph, the line (charted as I vs. V) is shown to increase in a 45 deg. straight line (constant resistance region of the chart, where the Thermistor's resistance is stable) until the maximum current point is reached. Beyond the maximum current point, the line decreases at a 45deg straight line (constant power region of the chart, where the Thermistor's resistance sharply increases).

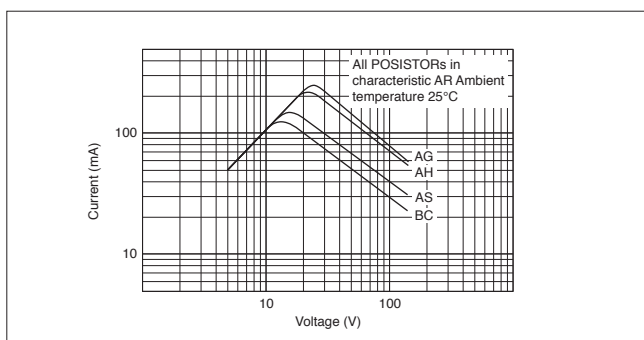

Fig. 4-1 Changing Curie point

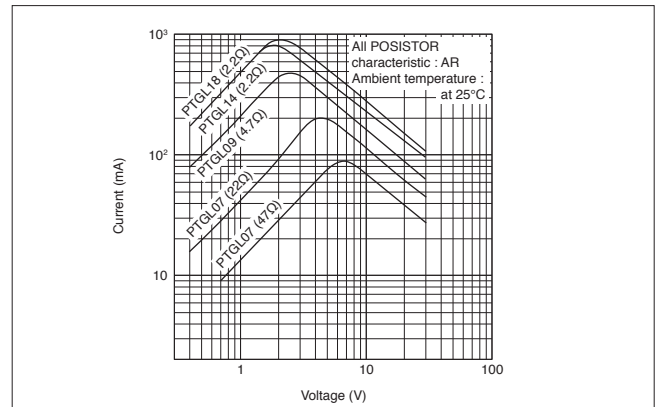

Fig. 4-2 Changing dimension and resistance value

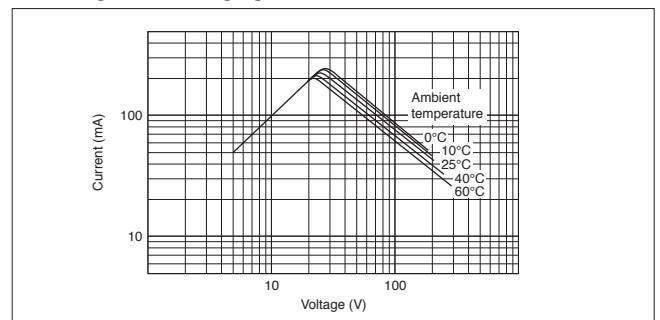

Fig. 4-3 Changing ambient temperature

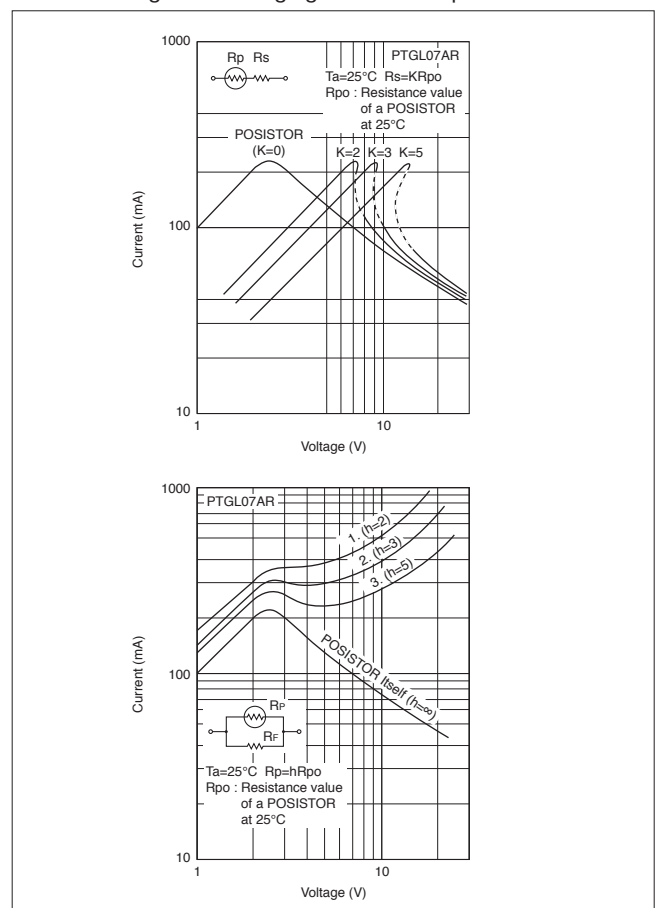

Fig. 5 Change of static characteristic of POSISTOR by series and parallel resistance

2 The basic design data

3. Current - time characteristics (Dynamic Characteristics)

If a specific voltage, above the V-I chart's maximum current point, is applied to the POSISTOR® a large amount of current will flow through POSISTOR, because its resistance is low. The POSISTOR will start to self-heat due to the current, and over a period of time the temperature of the POSISTOR will exceed the C_p and its resistance will sharply increase. Due to this, the current will eventually stabilize at a constant level. (Fig. 6-1 and 6-2)

If the initial applied voltage is increased, the time needed for the POSISTOR to self-heat beyond its C_p is reduced, due to the larger current flow causing faster self-heating of the POSISTOR. (Fig. 6-3)

If a resistor is connected with POSISTOR in series or in parallel, the dynamic characteristics can be changed as well. (Fig. 7)

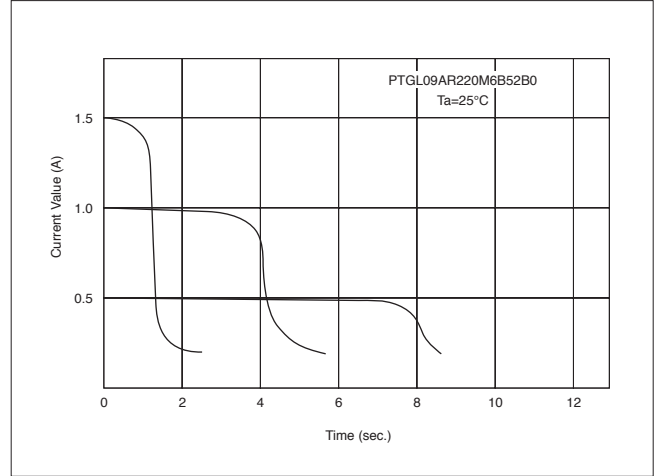

Fig. 6-3 Inrush current and attenuation

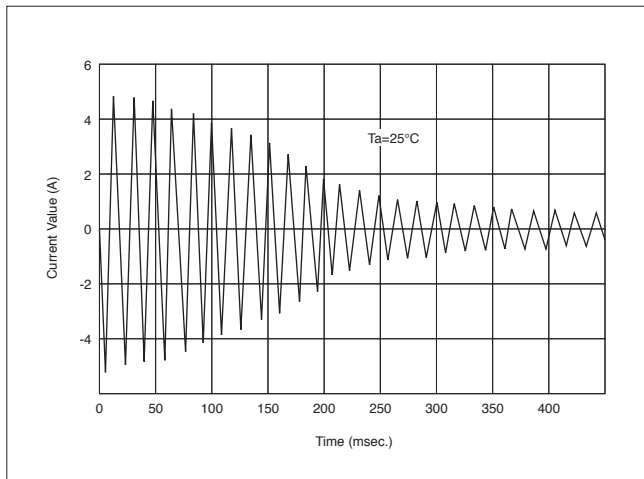

Fig. 6-1 Current - time characteristic (AC)

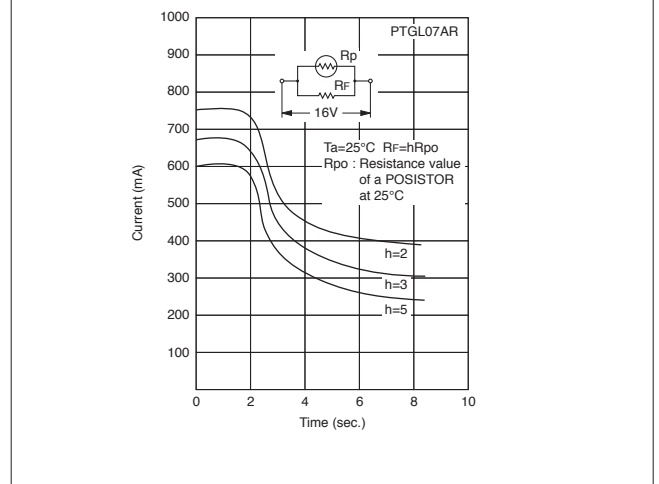
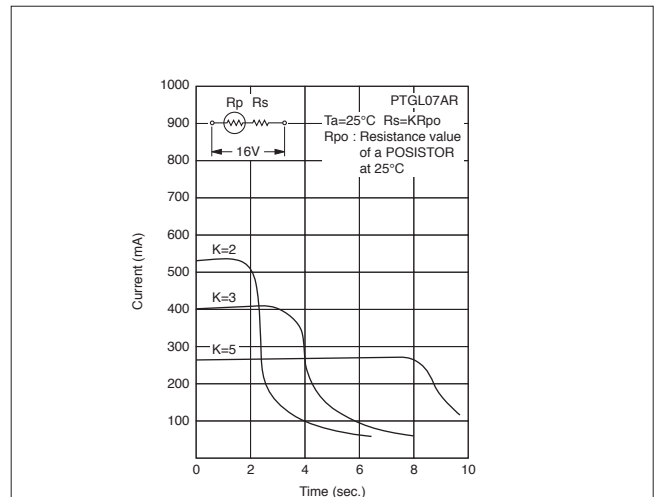

Fig. 7 Change of dynamic characteristic of POSISTOR by series or parallel resistance

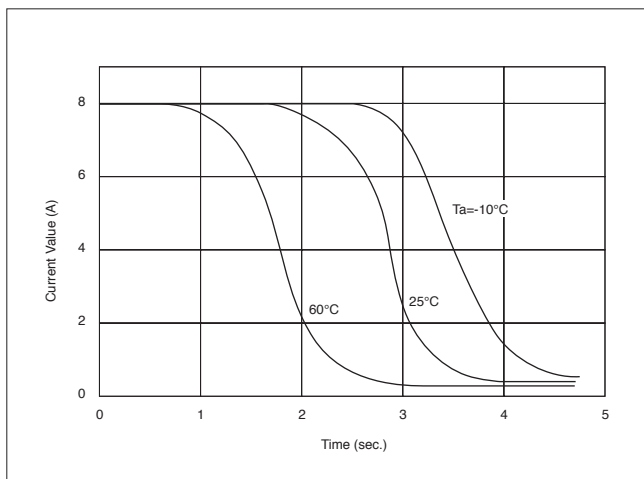

Fig. 6-2 Current - time characteristic (DC, Ambient temperature change)

3 Structure of POSISTOR®

Leaded products of POSISTOR, as shown in Fig. 8, can have their POSISTOR element either: soldered to lead wires and its surface then coated with epoxy resin, or the element can be held in place by spring terminals and encased in a plastic housing. In the case of the latter, the spring terminals also provide the electrical connection and exit the housing as lead terminals. The shape of the POSISTOR can either be square or round. Recently, chip type POSISTORS are becoming more common.

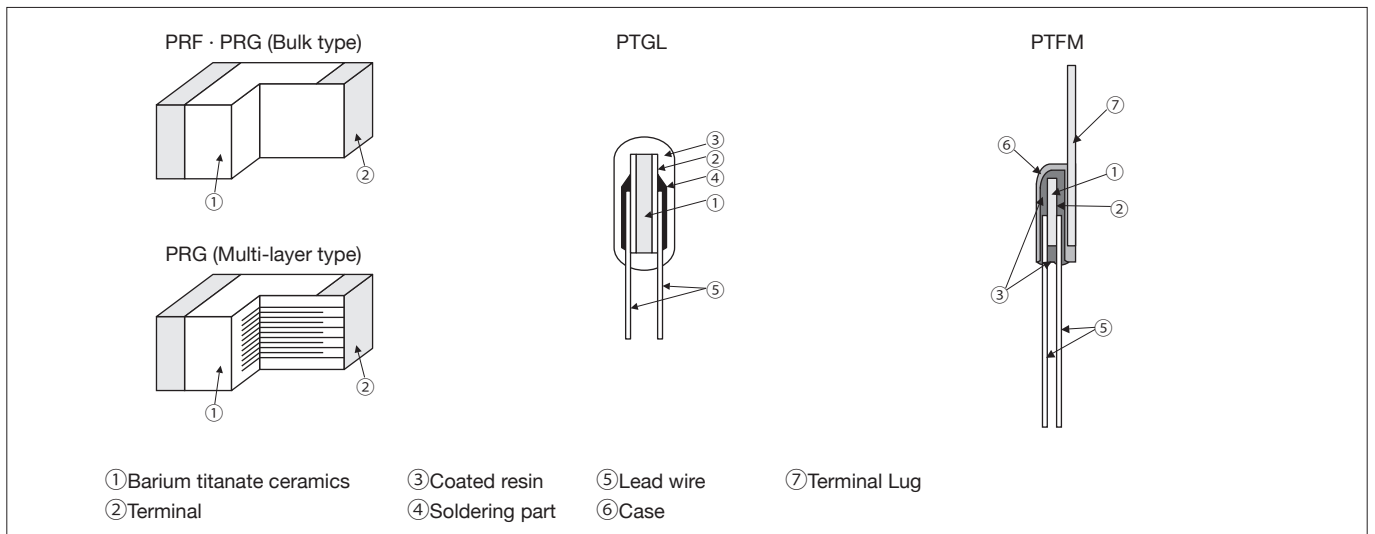

Fig. 8

4 Practical applications of POSISTOR®

1. For temperature sensor and temperature compensation

1. For temperature compensation and overheat sensing of transistors

Fig. 9(1) shows a basic circuit for temperature compensation. In biasing the transistor, the resistance of POSISTOR is used. If the transistor overheats, the POSISTOR will heat up as well. As the POSISTOR passes the C_p , it will go high resistance and unbiased the circuit, and turning off the transistor. In case of Fig. 9(2) and 9(3), it also can be used as an over heat sensor as well.

When POSISTOR is used for temperature compensation, it does not change the input impedance, like a negative temperature coefficient Thermistor (NTC Thermistor), because the POSISTOR is not connected to input circuit in parallel. Therefore, the POSISTOR is suitable for circuits which do not need a change of input impedance as a pulse circuits, regional amplifier, and measurement equipment.

More than two pieces of POSISTOR can cover multi hot spots working with a comparator. Fig. 9-2 shows basic circuit idea to connect multiple POSISTOR in series. When One POSISTOR detects overheat at least, a comparator can work by the sharp temperature-resistance characteristic. It easily allows changing a number of POSISTOR or sensing temperature in the same basic circuit design.

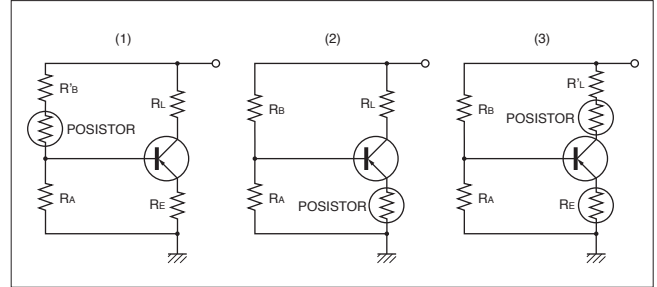

Fig. 9 Temperature compensation and protection of transistor

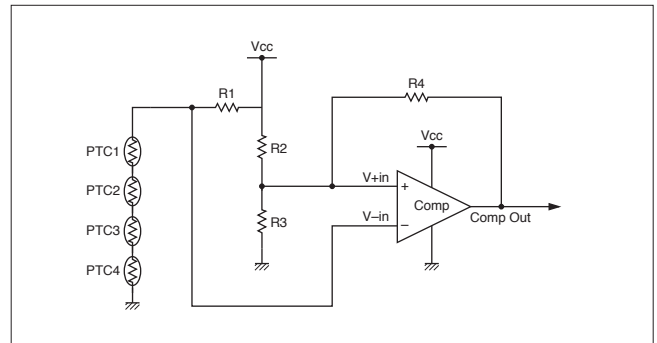
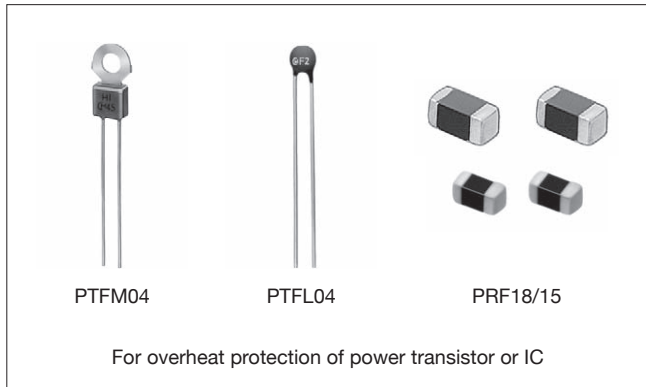

Fig. 9-2 Connection of multiple POSISTOR

2. Overheat sensing for motors and transformers

A POSISTOR can be used for the overheat sensing of motors, transformer winding, bearings, power transistors, and other machinery. Fig. 10(1) shows an example of overheat sensing for motor using a relay. In case of small regular operating current, the circuit can be directly stopped by POSISTOR. In case of larger regular operating currents, the circuit can be stopped by using the POSISTOR with a relay or a thyristor. In either case, POSISTOR is a very easy to use device, because it's small, light, and a two terminals device.

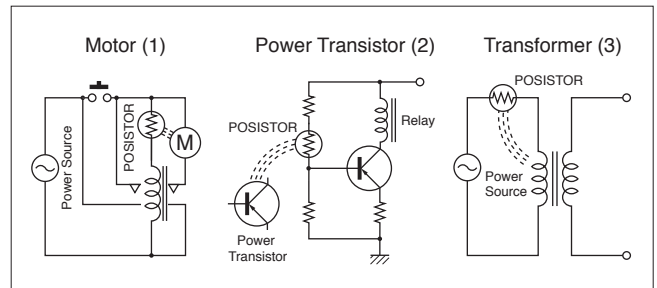

Fig. 10 Protection from overheat by POSISTOR

Practical applications of POSISTOR® 4

3. For temperature indication

Fig. 14 shows most simple example of a temperature indicator. Temperature is sensed by POSISTOR. If the target temperature is exceeded (determined by which POSISTOR is used), a neon tube lights up.

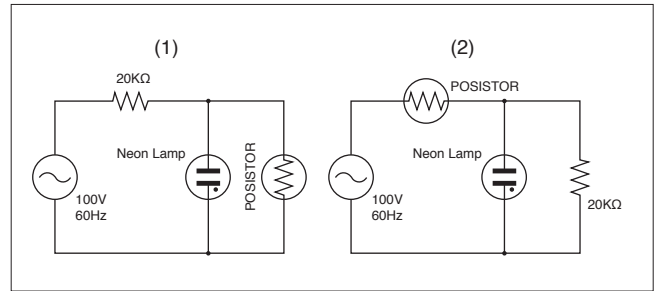
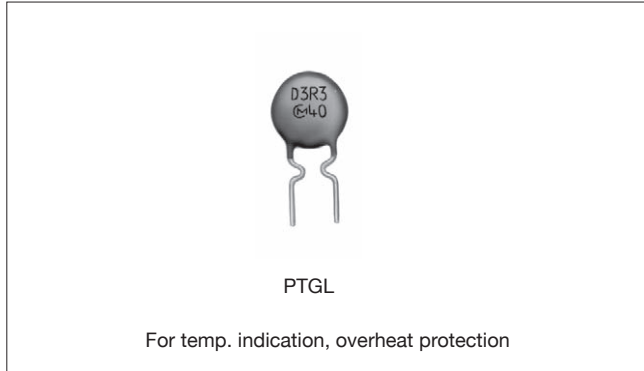

Fig. 11 Temperature indication by POSISTOR

4 Practical applications of POSISTOR®

2. For current control

1. Over current protection

If a circuit's current limit is exceeded, a POSISTOR can react to the higher current (self heating) and quickly protect the circuit. (Fig. 12)

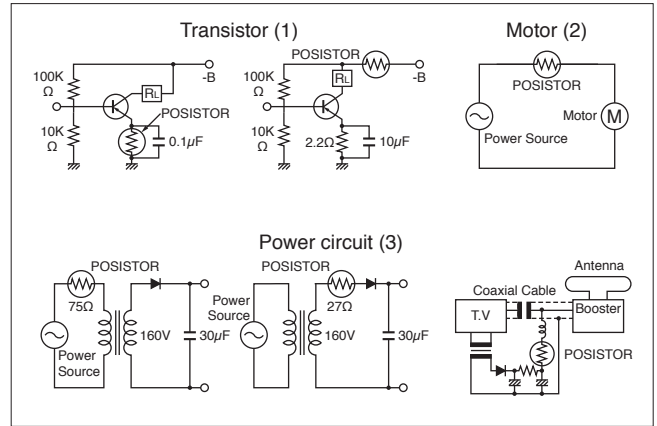
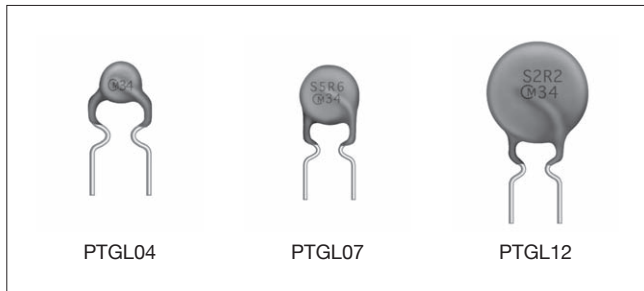

Fig. 12 Protection from over current

2. Delay Circuit

A delay function can be created by using the dynamic characteristics of POSISTOR. There are two methods: one is with the POSISTOR connected in parallel with a relay as in Fig. 13(1) and the other is similar but with series connection, as in Fig. 13(2) and (3).

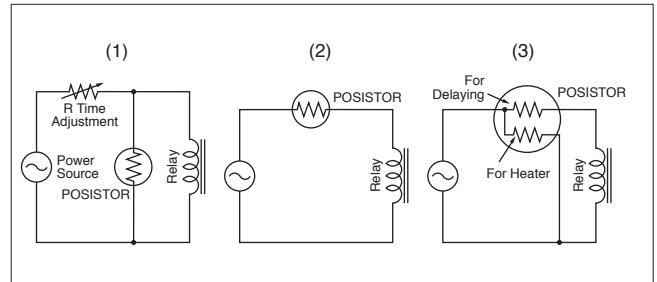
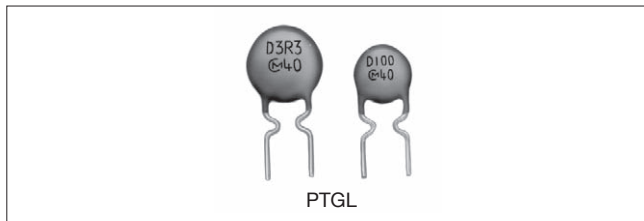

Fig. 13 Delay operation of relay

3. For the control of inrush current

A switching power supply has large inrush current when it first turns on. If POSISTOR is used, instead of a resistor or an NTC Thermistor, the POSISTOR works as inrush current limiter. The POSISTOR self heats due to over current in the case of relay or thyristor's failure and will trip to high resistance, quickly shutting off the current. (Fig. 14)

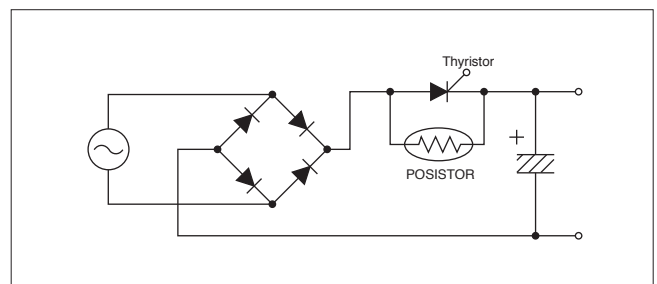

Fig. 14 Inrush current limit circuit

5 Terms

Definitions of typical terms for POSISTOR®s are listed here.

1. Initial resistance (R25)

This is the part's resistance value at 25degC which is measured under conditions of 1.0VDC or less, and 10mA or less without self-heating.

2. Curie point (C.P.) temperature (Resistance - temperature characteristics)

A POSISTOR maintains almost the same resistance, until certain temperature. After this temperature is exceeded, the resistance of POSISTOR rises up sharply. This transition point is called the "Curie point" or "C.P.". Murata defines this critical temperature to be the 'Curie point' temperature, where the actual resistance value is twice the reference value measured at 25degC.

3. Maximum operating voltage

Within the operating temperature range of POSISTOR, it is the largest voltage that can be applied continuously.

4. Withstanding voltage

The maximum voltage which the POSISTOR can withstand over a three minute period, at 25deg. To test, the input voltage is raised to withstanding voltage from zero voltage gradually.

5. Heat dissipation factor (D)

It is the amount of heat which is lost, over a unit of time, based on 1degC temperature difference between heating element and ambient temperature.

$$W=I \cdot V=D(T-T_0)$$

T: temperature of heating element

T₀: ambient temperature

D: heat dissipation factor (W/degC)

Generally this value is decided by a size, a structure and material of heating element.

6. Thermal time constant (γsec)

It is the time needed, to achieve 0.632 times the temperature difference between T₀ to T₁.

γ=H/D, Here D, Heat dissipation factor (W/degC), H: Heat capacity (Wsec/degC) This formula is related to dynamic characteristics.

7. Operation point

It is an equilibrium condition between self-heating of the POSISTOR and the external radiator.

■ Strict observance:

POSISTOR is not hermetically sealed, do not use it under the below conditions. If POSISTOR is used in such conditions, they may cause decline of characteristics or may lead to short-circuit type failure.

- Corrosive gas atmosphere (Cl₂, NH₃, SO_x, NO_x and so on)
- Volatile, flammable gas atmosphere
- Dusty area
- Pressurized air or vacuum atmosphere
- Direct contact with water, standing water on the part, or high humidity.
- Exposure to salt, grease, chemicals, organic solvents
- Place with a lot of vibration
- Anything equivalent to the above mentions

■ Notice:

POSISTOR should be evaluated, after confirmation of rated value, and using precautions as given in the catalog.

⚠ **Note:**

1. Export Control

<For customers outside Japan>

No Murata products should be used or sold, through any channels, for use in the design, development, production, utilization, maintenance or operation of, or otherwise contribution to (1) any weapons (Weapons of Mass Destruction [nuclear, chemical or biological weapons or missiles] or conventional weapons) or (2) goods or systems specially designed or intended for military end-use or utilization by military end-users.

<For customers in Japan>

For products which are controlled items subject to the "Foreign Exchange and Foreign Trade Law" of Japan, the export license specified by the law is required for export.

2. Please contact our sales representatives or product engineers before using the products in this catalog for the applications listed below, which require especially high reliability for the prevention of defects which might directly damage a third party's life, body or property, or when one of our products is intended for use in applications other than those specified in this catalog.

- | | |
|-----------------------------|--|
| ① Aircraft equipment | ② Aerospace equipment |
| ③ Undersea equipment | ④ Power plant equipment |
| ⑤ Medical equipment | ⑥ Transportation equipment (vehicles, trains, ships, etc.) |
| ⑦ Traffic signal equipment | ⑧ Disaster prevention / crime prevention equipment |
| ⑨ Data-processing equipment | ⑩ Application of similar complexity and/or reliability requirements to the applications listed above |

3. Product specifications in this catalog are as of November 2013. They are subject to change or our products in it may be discontinued without advance notice.

Please check with our sales representatives or product engineers before ordering. If there are any questions, please contact our sales representatives or product engineers.

4. Please read rating and ⚠ CAUTION (for storage, operating, rating, soldering, mounting and handling) in this catalog to prevent smoking and/or burning, etc.

5. This catalog has only typical specifications. Therefore, please approve our product specifications or transact the approval sheet for product specifications before ordering.

6. Please note that unless otherwise specified, we shall assume no responsibility whatsoever for any conflict or dispute that may occur in connection with the effect of our and/or a third party's intellectual property rights and other related rights in consideration of your use of our products and/or information described or contained in our catalogs. In this connection, no representation shall be made to the effect that any third parties are authorized to use the rights mentioned above under licenses without our consent.

7. No ozone depleting substances (ODS) under the Montreal Protocol are used in our manufacturing process.