

## Minimum Quantity and 8mm Width Taping Dimensions

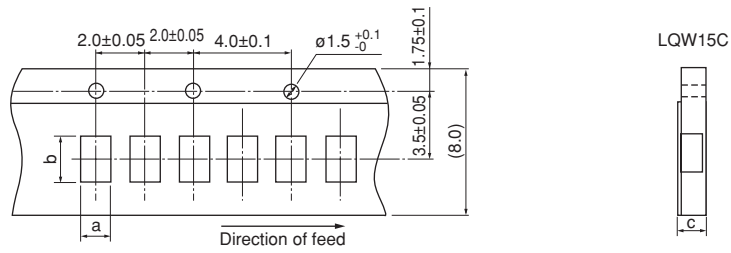

Paper Tape

| Part Number | Dimensions |      | Total Thickness of Tape | Packaging Code (Minimum Qty. [pcs.]) |             |             |
|-------------|------------|------|-------------------------|--------------------------------------|-------------|-------------|
|             | a          | b    |                         | c                                    | ø180mm reel | ø330mm reel |
| LQW15C_00   | 0.64       | 1.18 | 0.8 max.                | D [10000]                            | -           | B [500]     |
| LQW15C_10   | 0.69       | 1.18 | 0.8 max.                | D [10000]                            | -           | B [500]     |

(in mm)

Continued on the following page.

■ Minimum Quantity and 8mm Width Taping Dimensions

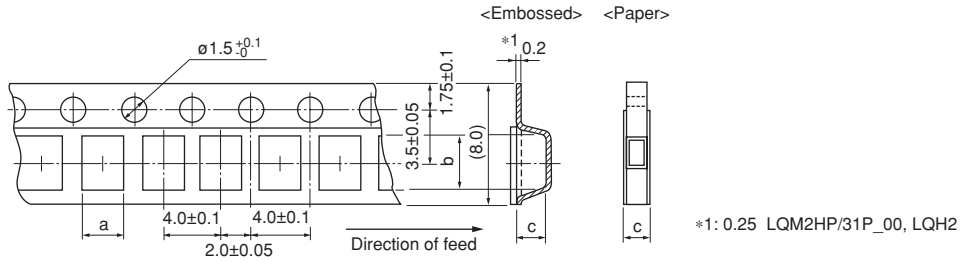

Dimension of the cavity of embossed tape is measured at the bottom side.

Paper Tape

| Part Number      | Dimensions |      | Total Thickness of Tape | Packaging Code (Minimum Qty. [pcs.]) |             |             |
|------------------|------------|------|-------------------------|--------------------------------------|-------------|-------------|
|                  | a          | b    |                         | c                                    | ø180mm reel | ø330mm reel |
| LQM21D (1-10μH)  | 1.45       | 2.25 | 1.1 max.                | D [4000]                             | J [10000]   | B [1000]    |
| LQM21F (1-2.2μH) | 1.45       | 2.25 | 1.1 max.                | D [4000]                             | J [10000]   | B [1000]    |
| LQM21P_C0        | 1.45       | 2.25 | 0.8 max.                | D [4000]                             | -           | B [1000]    |
| LQM21P_G         | 1.45       | 2.25 | 1.1 max.                | D [4000]                             | -           | B [1000]    |
| LQM18F           | 1.05       | 1.85 | 1.1 max.                | D [4000]                             | J [10000]   | B [1000]    |
| LQM18P_D0        | 1.05       | 1.85 | 0.85 max.               | D [4000]                             | -           | B [1000]    |
| LQW18C           | 1.0        | 1.8  | 1.1 max.                | D [4000]                             | -           | B [500]     |

Embossed Tape

| Part Number       | Dimensions |      | Depth of Cavity | Packaging Code (Minimum Qty. [pcs.]) |             |             |
|-------------------|------------|------|-----------------|--------------------------------------|-------------|-------------|
|                   | a          | b    |                 | c                                    | ø180mm reel | ø330mm reel |
| LQM18P_B0         | 1.0        | 1.8  | 0.50            | L [4000]                             | -           | B [1000]    |
| LQM18P_C0         | 1.0        | 1.8  | 0.60            | L [4000]                             | -           | B [1000]    |
| LQM18P_F0         | 1.0        | 1.8  | 1.0             | L [4000]                             | -           | B [1000]    |
| LQM21D (22-47μH)  | 1.45       | 2.25 | 1.3             | L [3000]                             | K [10000]   | B [1000]    |
| LQM21F (4.7-47μH) | 1.45       | 2.25 | 1.3             | L [3000]                             | K [10000]   | B [1000]    |
| LQM2HP_J0/JC      | 2.25       | 2.75 | 1.3             | L [3000]                             | -           | B [1000]    |
| LQM2HP_G          | 2.3        | 2.8  | 1.1             | L [3000]                             | -           | B [1000]    |
| LQM2HP_E0         | 2.3        | 2.8  | 0.9             | L [3000]                             | -           | B [1000]    |
| LQM2MP_G0         | 1.85       | 2.25 | 1.1             | L [3000]                             | -           | B [1000]    |
| LQM31P_00         | 1.9        | 3.5  | 1.05            | L [3000]                             | -           | B [1000]    |
| LQM31P_C0         | 1.9        | 3.5  | 0.75            | L [4000]                             | -           | B [1000]    |
| LQM32P_G0         | 2.9        | 3.6  | 1.15            | L [3000]                             | -           | B [1000]    |
| LQH31C            | 1.9        | 3.6  | 2.0             | L [2000]                             | K [7500]    | -           |
| LQH32C_33/_23     | 2.9        | 3.6  | 2.1             | L [2000]                             | K [7500]    | -           |
| LQH32C_53         | 2.9        | 3.6  | 1.7             | L [2000]                             | K [7500]    | -           |
| LQH32P            | 2.9        | 3.6  | 1.7             | L [2000]                             | K [7500]    | -           |
| LQH2MC_02         | 1.9        | 2.3  | 1.05            | L [3000]                             | -           | B [100]     |
| LQH2MC_52         | 1.9        | 2.3  | 0.8             | L [3000]                             | -           | B [100]     |

(in mm)

Continued on the following page.

Minimum Quantity and 8mm Width Taping Dimensions

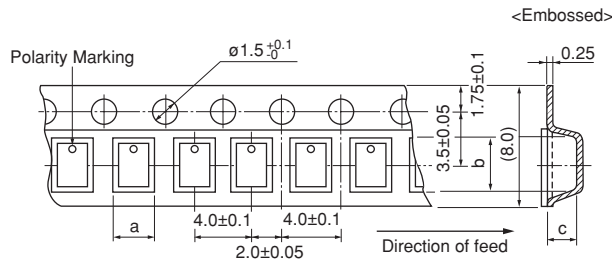

Dimension of the cavity of embossed tape is measured at the bottom side.

Embossed Tape

| Part Number | Dimensions |     | Depth of Cavity | Packaging Code (Minimum Qty. [pcs.]) |             |             |
|-------------|------------|-----|-----------------|--------------------------------------|-------------|-------------|
|             | a          | b   |                 | c                                    | ø180mm reel | ø330mm reel |
| LQH2HP_G0   | 2.3        | 2.8 | 1.1             | L [3000]                             | -           | -           |
| LQH2HP_J0   | 2.3        | 2.8 | 1.3             | L [2000]                             | -           | -           |
| LQH2HP_M0   | 2.3        | 2.8 | 1.6             | L [2000]                             | -           | -           |

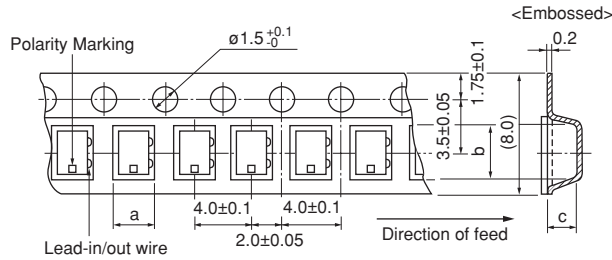

Dimension of the cavity of embossed tape is measured at the bottom side.

Embossed Tape

| Part Number | Dimensions |     | Depth of Cavity | Packaging Code (Minimum Qty. [pcs.]) |             |             |
|-------------|------------|-----|-----------------|--------------------------------------|-------------|-------------|
|             | a          | b   |                 | c                                    | ø180mm reel | ø330mm reel |
| LQH3NP_MR   | 3.3        | 3.3 | 1.6             | E [2000]                             | F [8000]    | -           |

(in mm)

Continued on the following page.

■ Minimum Quantity and 12mm Width Embossed Taping Dimensions

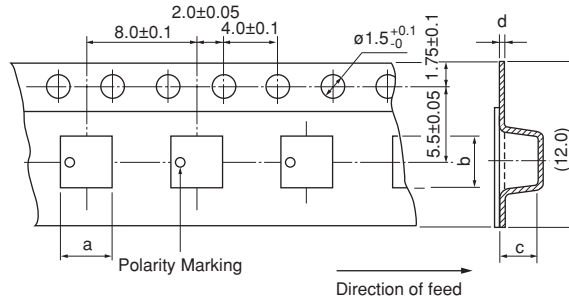

Dimension of the cavity of embossed tape is measured at the bottom side.

Embossed Tape

| Part Number | Dimensions (*c: Depth of Cavity) |     |     |      | Packaging Code (Minimum Qty. [pcs.]) |             |      |
|-------------|----------------------------------|-----|-----|------|--------------------------------------|-------------|------|
|             | a                                | b   | c   | d    | ø180mm reel                          | ø330mm reel | Bulk |
| LQH3NP_M0   | 3.3                              | 3.3 | 1.6 | 0.25 | L [1000]                             | K [4000]    | -    |
| LQH3NP_J0   | 3.3                              | 3.3 | 1.3 | 0.25 | L [1000]                             | K [5000]    | -    |
| LQH3NP_G0   | 3.3                              | 3.3 | 1.1 | 0.25 | L [1500]                             | K [6000]    | -    |

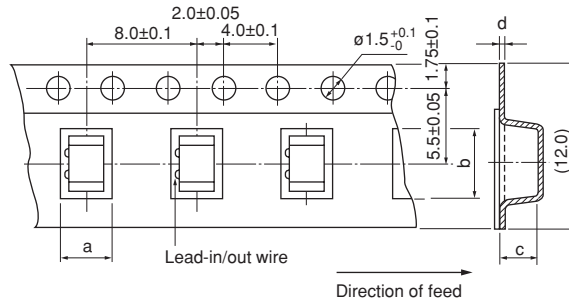

Dimension of the cavity of embossed tape is measured at the bottom side.

Embossed Tape

| Part Number | Dimensions (*c: Depth of Cavity) |     |     |     | Packaging Code (Minimum Qty. [pcs.]) |             |      |
|-------------|----------------------------------|-----|-----|-----|--------------------------------------|-------------|------|
|             | a                                | b   | c   | d   | ø180mm reel                          | ø330mm reel | Bulk |
| LQH43C      | 3.6                              | 4.9 | 2.7 | 0.3 | L [500]                              | -           | -    |
| LQH43P      | 3.6                              | 4.9 | 2.7 | 0.3 | L [500]                              | K [2500]    | -    |
| LQH44 P_J0  | 4.3                              | 4.3 | 1.4 | 0.3 | L [1000]                             | K [3500]    | -    |
| LQH44P_P0   | 4.3                              | 4.3 | 1.9 | 0.3 | L [1000]                             | K [3500]    | -    |
| LQH5BP      | 5.3                              | 5.3 | 2.4 | 0.3 | L [500]                              | K [3000]    | -    |
| LQH55D      | 5.4                              | 6.1 | 5.0 | 0.4 | L [350]                              | K [1500]    | -    |
| LQH66S      | 6.7                              | 6.7 | 5.6 | 0.4 | L [350]                              | K [1500]    | -    |

(in mm)

■ Minimum Quantity and 12mm Width Embossed Taping Dimensions

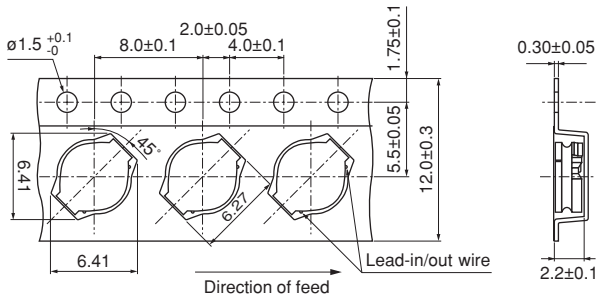

Dimension of the cavity of embossed tape is measured at the bottom side.

Embossed Tape

| Part Number | Packaging Code (Minimum Qty. [pcs.]) |             |      |
|-------------|--------------------------------------|-------------|------|
|             | ø180mm reel                          | ø330mm reel | Bulk |
| LQH55P      | L [500]                              | K [3000]    | -    |

(in mm)